

# Intelligent Portable Measuring Instrument

OHE-TWP02-D



## Overview

OHE-TWP02-D offers body temperature and environmental temperature and humidity measurement modes. It can automatically switch to the body temperature mode when its distance measurement sensor detects human body, and the built-in infrared thermopile sensor can accurately detect the radiation of infrared light emitted from human body surface to measure body temperature. The humidity sensor integrated inside can monitor the environmental temperature and humidity. The non-contact measurement avoids cross-infection, and its high-brightness segment LCD offers clear display and is easy to operate. OHE-TWP02-D is suitable for indoor scenarios such as communities, shopping malls, office buildings, schools, etc.

## Dimensions

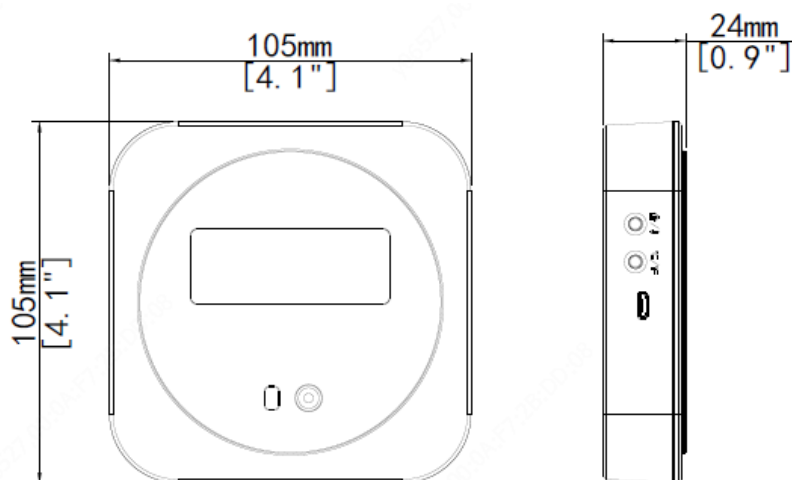









## Features

- Non-contact wrist temperature measurement avoids cross-infection.
- Supports environmental temperature and humidity monitoring.
- High accuracy, with measurement deviation less than 0.2°C, and measurement distance less than 5cm.
- Automatically measures body temperature when human body is detected, without the need to press any button.
- Provides warnings for various events including high body temperature and out of temperature range.
- High-brightness LCD display allows clear view even under strong sunlight.

## Order Info

Model	Remarks
OHE-TWP02-D	Intelligent portable measuring instrument
OHE-TWP02-D-S31	Intelligent portable measuring instrument and bracket

## Specifications

Parameter	Description
Working mode	Automatic mode: Displays the environment temperature by default, and shows the body temperature when human body is detected within the measurement range. The body temperature will be displayed for 10s after no human body is detected. Displayed icon(flashing thermometer icon):  
	Environment temperature mode: Displays the environment temperature. Body temperature measurement and the distance measurement sensor are turned off. Displayed icon: 
	Body temperature mode: Displays --.°C / --.°F by default, and shows the body temperature when human body is detected within the measurement range. The body temperature will be displayed for 10s. Displayed icon: 
Alarm temperature	The default alarm temperature is 37.6°C. To modify the setting: 1. Press and hold mode switch button(  /  )and-plug in the power. The current setting is displayed. 2. Press mode switch button(  /  )once to increase 0.1, press unit switch button ( °C / °F ) once to decrease 0.1. The range is 37°C to 38°C (98.6°F to 100.4°F) . 3. To save the setting, wait for 10s. You will hear a beep and the setting is saved automatically.
Power on self test	After power on, all icons on the screen are all on, and the beeper beeps once
Body temperature measurement method	Non-contact, wrist temperature measurement
Temperature measurement range	Body: 32°C to 42°C Environment: 0°C to 50°C
Measurement resolution	0.1°C
Measurement deviation	Body: 35°C to 42°C: ±0.2°C,outside the above range: ±0.3°C
Measurement distance	≤5cm
Humidity range	0-99% RH
Humidity resolution	1% RH
Display	Segment LCD

	Switch between °C and °F
Beeper alarm	One beep: Temperature is below the alarm temperature
	Constant beeps: Temperature reaches or exceeds the alarm temperature
Material	Plastic
Power supply	5VDC±25%, Micro-USB
Dimensions	105mm*105mm*30mm
Mount	Adhesive wall mount/standard bracket mount
Operating temperature	0°C to 50°C (10°C to 40°C environment temperature in body temperature mode)
Operating humidity	≤85% RH, non-condensing
Storage temperature	-20°C to +60°C
Storage humidity	≤85% RH, non-condensing
Operating environment	Indoor

**Zhejiang Uniview Technologies Co., Ltd.**

Building No.10, Wanlun Science Park, Jiangling Road 88, Binjiang District, Hangzhou, Zhejiang, China (310051)

Email: [overseasbusiness@uniview.com](mailto:overseasbusiness@uniview.com); [globalsupport@uniview.com](mailto:globalsupport@uniview.com)

<http://www.uniview.com>

©2020 Zhejiang Uniview Technologies Co., Ltd. All rights reserved.

\*Product specifications and availability are subject to change without notice.