



# User Manual

Robot Vacuum & Mop  
+ Smart Auto-Empty Dock

\*Images may differ from actual products.

©2023 TP-Link 7106509944 REV1.1.0



# IMPORTANT SAFETY INSTRUCTIONS

## READ ALL INSTRUCTIONS BEFORE USING THIS APPLIANCE

WARNING – To reduce the risk of fire, electric shock, or injury:

- Do not leave appliance when plugged in. Unplug from outlet when not in use and before servicing.
- Do not use outdoors or on wet surfaces.
- Do not allow to be used as a toy. Close attention is necessary when used by or near children.
- Use only as described in this manual. Use only manufacturer's recommended attachments.
- Do not use with damaged cord or plug. If appliance is not working as it should, has been dropped, damaged, left outdoors, or dropped into water, return it to a service center.
- Do not pull or carry by cord, use cord as a handle, close a door on cord, or pull cord around sharp edges or corners. Do not run appliance over cord. Keep cord away from heated surfaces.
- Do not unplug by pulling on cord. To unplug, grasp the plug, not the cord.
- Do not handle plug or appliance with wet hands.
- Do not put any object into openings. Do not use with any opening blocked; keep free of dust.
- Do not use to pick up flammable or combustible liquids, such as gasoline, or use in areas where they may be present.
- Keep hair, loose clothing, fingers, and all parts of body away from openings and moving parts.
- Turn off all controls before unplugging.
- Do not put any object into openings. Do not use with any opening blocked; keep free of dust, lint, hair, and anything that may reduce air flow.
- Do not pick up anything that is burning or smoking, such as cigarettes, matches, or hot ashes.
- Do not use without dust bag and/or filters in place.
- Use extra care when cleaning on stairs.

WARNING: Do not charge non-rechargeable batteries.

WARNING: Read all safety warnings and instructions. Failure to follow the warnings and instructions may result in electric shock, fire and/or serious injury.

Risk of explosion. Floor sanding can result in an explosive mixture of fine dust and air. Use floor-sanding machine only in a well-ventilated area free from any flame or match.

- Prevent unintentional starting. Ensure the switch is in the off-position before connecting to battery pack, picking up or carrying the appliance. Carrying the appliance with your finger on the switch or energizing appliance that have the switch on invites accidents.

- Recharge only with the charger specified by the manufacturer. A charger that is suitable for one type of battery pack may create a risk of fire when used with another battery pack.
- Use appliances only with specifically designated battery packs. Use of any other battery packs may create a risk of injury and fire.
- Under abusive conditions, liquid may be ejected from the battery; avoid contact. If contact accidentally occurs, flush with water. If liquid contacts eyes, additionally seek medical help. Liquid ejected from the battery may cause irritation or burns.
- When battery pack is not in use, keep it away from other metal objects, like paper clips, coins, keys, nails, screws or other small metal objects, that can make a connection from one terminal to another. Shorting the battery terminals together may cause burns or a fire.
- Do not use a battery pack or appliance that is damaged or modified. Damaged or modified batteries may exhibit unpredictable behavior resulting in fire, explosion or risk of injury.
- Do not expose a battery pack or appliance to fire or excessive temperature. Exposure to fire or temperature above 130°C may cause explosion.
- Follow all charging instructions and do not charge the battery pack or appliance outside of the temperature range specified in the instructions. Charging improperly or at temperatures outside of the specified range may damage the battery and increase the risk of fire.
- Do not charge the battery at ambient temperature below 39°F (4°C) or above 104 °F (40°C). Also keeping the temperature range of between 39-104°F when storing unit or during use.
- Have servicing performed by a qualified repair person using only identical replacement parts. This will ensure that the safety of the product is maintained.
- Do not modify or attempt to repair the appliance except as indicated in the instructions for use and care.
- Place the cords from other appliances out of the area to be cleaned.
- Do not operate the vacuum in a room where an infant or child is sleeping.
- Do not operate the vacuum in an area where there are lit candles or fragile objects on the floor to be cleaned.
- Do not operate the vacuum in a room that has lit candles on furniture that the vacuum may accidentally hit or bump into.
- Do not allow children to sit on the vacuum.
- Do not use the vacuum on a wet surface.
- To reduce the risk of electric shock, this appliance has a polarized plug (one blade is wider than the other). This plug will fit in a polarized outlet only one way. If the plug does not fit fully in the outlet, reverse the plug. If it still does not fit, contact a qualified electrician to install the proper outlet. Do not change the plug in any way.
- Household use only

WARNING: Do not charge non-rechargeable batteries.

## SAVE THESE INSTRUCTIONS

**For Robot Vacuum:**

TP-Link hereby declares that the device is in compliance with the essential requirements and other relevant provisions of directives 2014/53/EU, 2009/125/EC, 2011/65/EU and (EU) 2015/863. The original EU declaration of conformity may be found at <https://www.tapo.com/en/support/ce/>

TP-Link hereby declares that the device is in compliance with the essential requirements and other relevant provisions of the Radio Equipment Regulations 2017.

The original UK declaration of conformity may be found at <https://www.tapo.com/support/ukca/>

**Safety Information**

Keep the device away from water, fire, humidity or hot environments.

This appliance contains batteries that are only replaceable by skilled persons.

Do not attempt to disassemble, repair, or modify the device. If you need service, please contact us.

If the supply cord is damaged, it must be replaced by the manufacturer, its service agent or similarly qualified persons in order to avoid a hazard.

**Warning**

Avoid replacement of a battery with an incorrect type that can defeat a safeguard.

Avoid disposal of a battery into fire or a hot oven, or mechanically crushing or cutting of a battery, that can result in an explosion.

Do not leave a battery in an extremely high temperature surrounding environment that can result in an explosion or the leakage of flammable liquid or gas;

Do not leave a battery subjected to extremely low air pressure that may result in an explosion or the leakage of flammable liquid or gas.

The instructions shall state the substance of the following:

This appliance is not intended for use by persons (including children) with reduced physical, sensory or mental capabilities, or lack of experience and knowledge, unless they have been given supervision or instruction concerning use of the appliance by a person responsible for their safety.

Children should be supervised to ensure that they do not play with the appliance.

The appliance is only to be used with the power supply unit provided with the appliance.

WARNING: For the purposes of recharging the battery, only use the detachable supply unit provided with this appliance.

The appliance contains a 2600mAh lithium-ion battery.

This appliance can be used by children aged from 8 years and above and persons with reduced physical, sensory or mental capabilities or lack of experience and knowledge if they have been given supervision or instruction concerning use of the appliance in a safe way and understand the hazards involved. Children shall not play with the appliance. Cleaning and user maintenance shall not be made by children without supervision.

**For Auto-Empty Dock / Battery:**

TP-Link hereby declares that the device is in compliance with the essential requirements and other relevant provisions of directives 2014/30/EU, 2014/35/EU, 2009/125/EC, 2011/65/EU and (EU)2015/863. The original EU declaration of conformity may be found at <https://www.tapo.com/en/support/ce/>

TP-Link hereby declares that the device is in compliance with the essential requirements and other relevant provisions of the Electromagnetic Compatibility Regulations 2016 and Electrical Equipment (Safety) Regulations 2016.

The original UK declaration of conformity may be found at <https://www.tapo.com/support/ukca/>

**For EU/UK Region**

Operating Frequency:

2400MHz~2483.5MHz / 20dBm

2402~2480MHz / 10dBm



# Package Contents

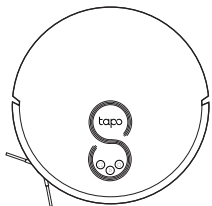

Robot Vacuum\*

\*One side brush and HEPA filter installed

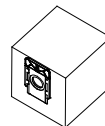
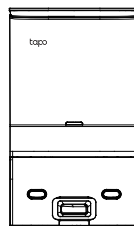

Auto-Empty Dock\* + Dust Bag ×1

\*One dust bag installed

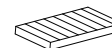

HEPA Filter ×1

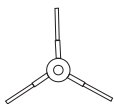

Side Brush ×1

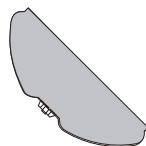

Mop Cloth Mount\* ×1

\*One washable mop cloth installed

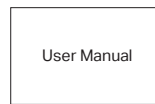

User Manual ×1

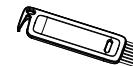

Cleaning Brush ×1

# Overview

## Robot Vacuum

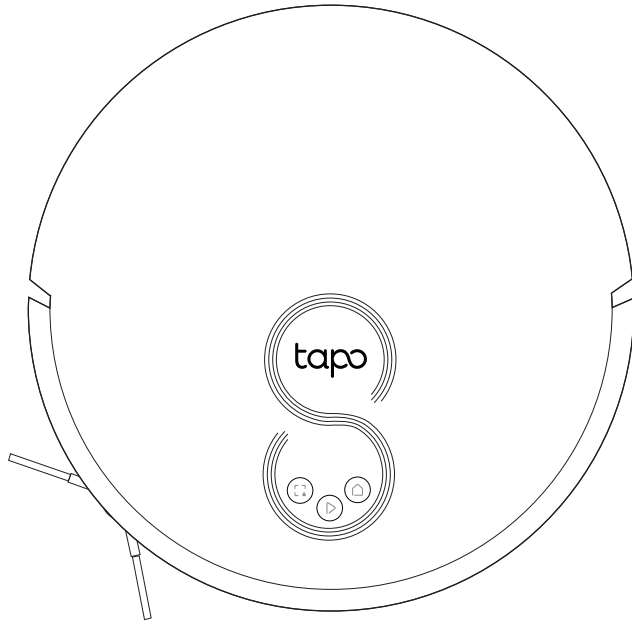

### Power/Clean

- Press once: Start/pause cleaning.
  - Press and hold for 5 seconds: Turn on/off the robot vacuum.
- \*For the first use, slide the power switch from OFF to ON to turn on.

### Dock

- Return to the dock to charge.
- Empty the bin when docked.

### Spot Cleaning/Child Lock

- Press once: Start spot cleaning.
- Press and hold for 5 seconds: Turn on/off the child lock.

### + Combination Button

- Press and hold simultaneously for 5 seconds: Enter setup mode to configure network.
- Press and hold simultaneously for 10 seconds: Restore to factory default settings.

### LED

- Red: Battery level < 20%; Error
- Orange: Battery level between 20% and 80%
- Green: Battery level > 80%

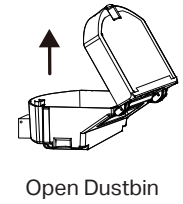
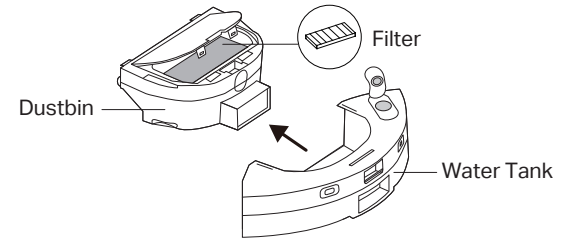
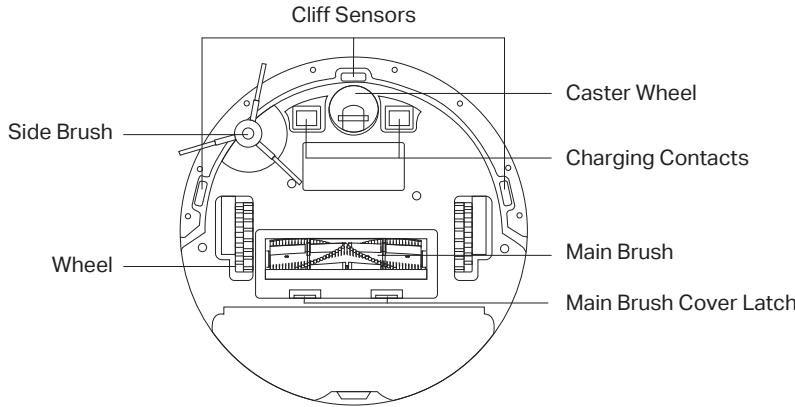
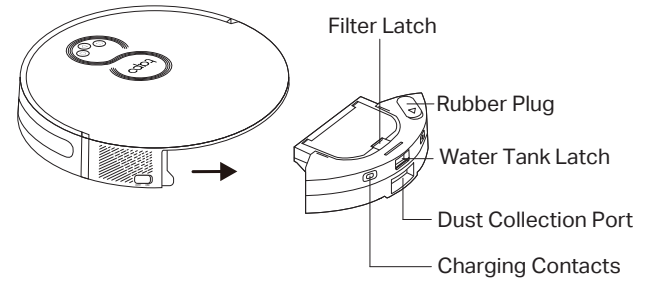
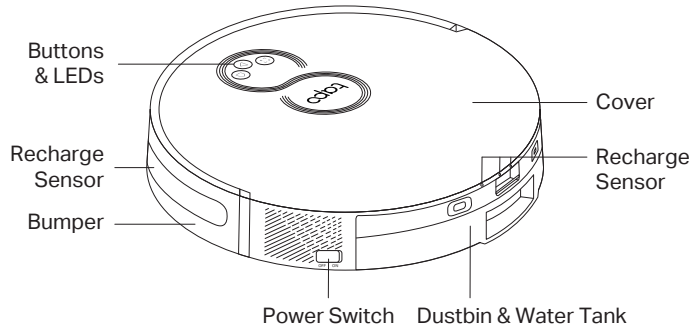



# Overview

## Auto-Empty Dock

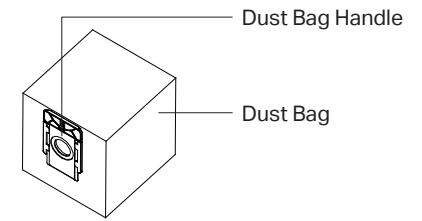
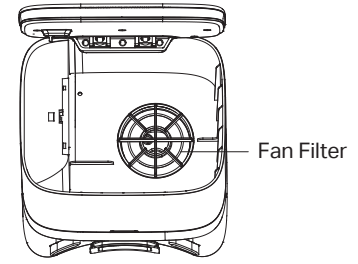
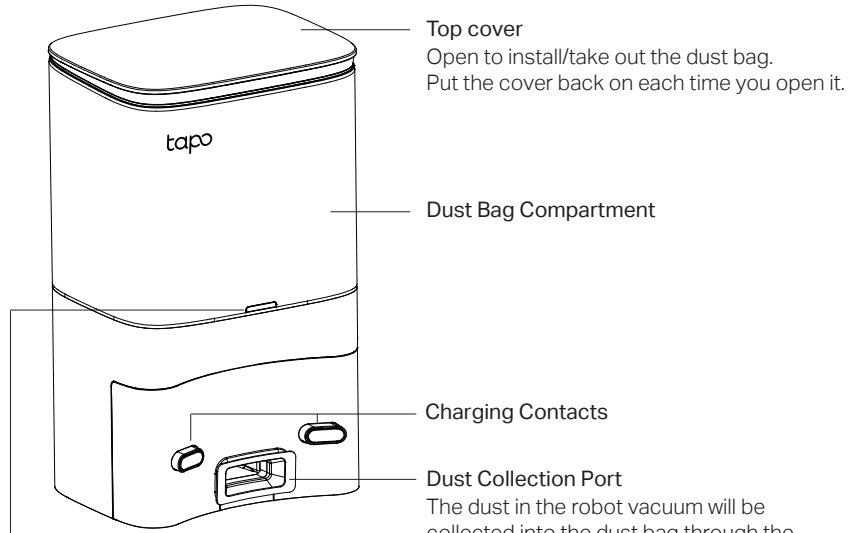

- LED Indicator**
- White: Working properly
  - Off: Robot vacuum is connected to the dock; sleeping.
  - Solid Red: Dust bag not installed; top cover not closed.
  - Flashing Red: Error

## 1 Position the Dock

1. Place the dock on a level surface, flat against a wall, without obstacles within 1.5m (4.9ft) in front and 0.5m (1.6ft) on left and right.
2. Connect the power cord to the dock. Ensure the cable is kept tidy.

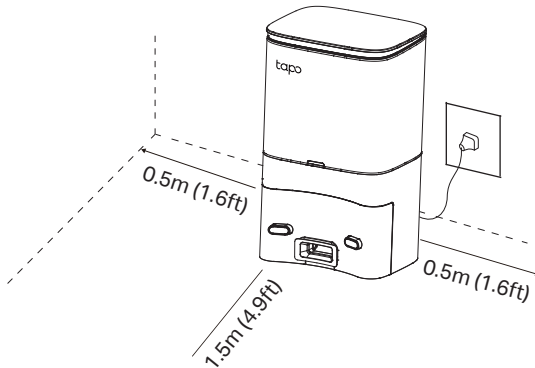

### Notes

- To ensure a better user experience, make sure the area is with good Wi-Fi signals.
- Do not place it in direct sunlight. Ensure the area around the dock is free of clutter to improve docking performance.
- To prevent the risk of your robot vacuum falling downstairs, ensure that the dock is placed at least 1.2m (4 ft) away from stairs.
- Always keep the dock powered on, otherwise the robot vacuum will not automatically return. And do not move the dock frequently.
- Place a waterproof pad to prevent the mop from wetting the floor when the robot vacuum is being charged.

## 2 Remove Protective Strip

Before use, remove the protective strips on both sides of the front bumper.

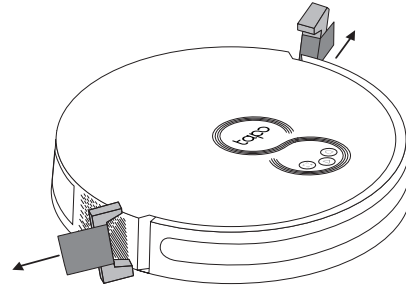

## 3 Remove Protective Film

Remove the protective film on the front bumper.

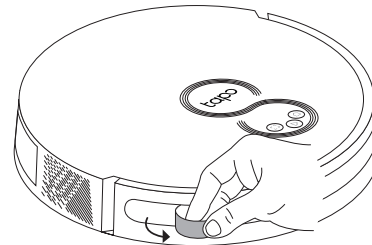



## 4 Power On and Charge

Slide the power switch from OFF to ON to turn on your robot vacuum.

### Notes

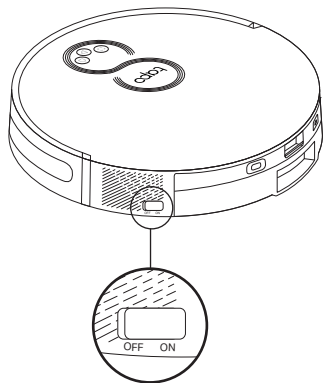
- If the power switch is in the ON position, you can also press and hold the  button for 5 seconds to turn on/off your robot vacuum.
- If the power switch is in the OFF position, the robot vacuum will automatically turn on when it is charged on the dock, and turn off when it leaves the charging dock.



Place the robot vacuum on the charging dock or tap  to send it back to the dock to charge. It will return to the dock at the end of a cleaning job and whenever it needs to recharge.

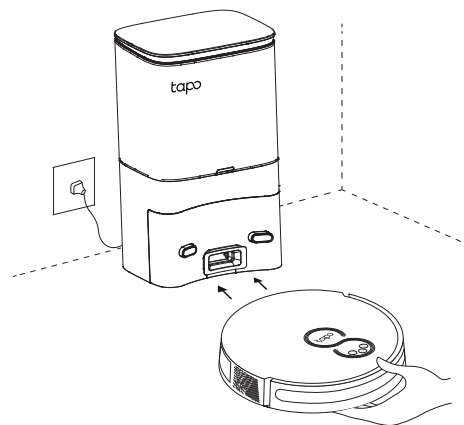

### Notes

- When the LED of the charging dock flashes 3 times and then goes out, the charging will begin.
- We recommend that you charge the robot vacuum fully for about 4 hours prior to starting the first cleaning job.

## 5 Download the Tapo App and Connect to Wi-Fi

1. Download the Tapo app from the App Store or Google Play, then log in.



In the Tapo app, you can enjoy the following functions.

- **Cleaning Modes & Preferences**  
Customize vacuum power, water level, and cleaning times.
- **Scheduled Cleaning**  
Set an automatic cleaning schedule, then the robot vacuum will clean automatically at the set time and return to the dock after cleaning.

2. Open the Tapo app, tap + icon, and select your model. Follow the step-by-step instructions to easily set up your robot vacuum.

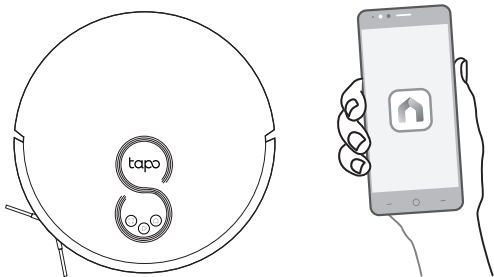

## 6 Cleaning

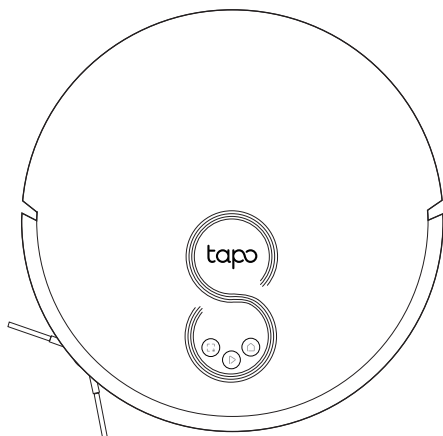

 **Press Once**  
Start/pause cleaning.

 **Press Once**  
Start spot cleaning.

### Notes

- Cleaning cannot start if the battery is too low. Charge your robot vacuum first.
- Pick up obstacles like wires, clothing, and plastic bags. Loose wires and objects may get caught in the robot vacuum, resulting in disconnection or damage to wires and property.
- Put away high pile carpet before cleaning.
- Do not pick up the robot vacuum during cleaning.
- If the cleaning area is too small, the area may be cleaned twice.
- If the robot vacuum is paused for 10 minutes, it will automatically enter sleep mode and the cleaning job will be canceled.

The robot vacuum will automatically explore and clean your home in neat rows. It will return to the charging station at the end of a cleaning job and whenever it needs to recharge.

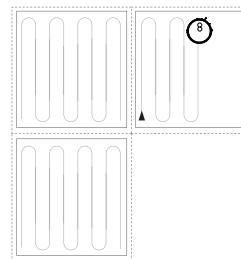

In Spot Cleaning mode, it will sweep the circular area with a diameter of 1.5m (4.9ft) calculated from its own position.

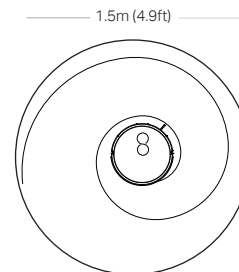

# 7 Mopping

1. Take out the dustbin and water tank.

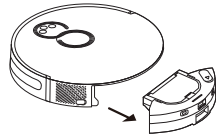

2. Remove the rubber plug and add water to the water tank.

- Fill with cool/room temperature water only. Be careful not to wet the metal contacts.
- Use only cleaning agents specified by Tapo. Others may corrode the water tank.

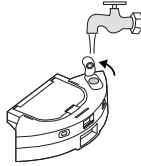

3. Install the washable mop cloth.

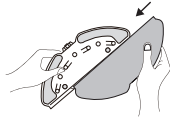

4. Install the mop cloth mount.

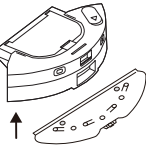

5. Re-install the dustbin and water tank.

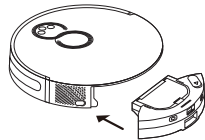

- Vacuum floors at least 3 times before the first mopping cycle.
- The ability to cross obstacles is reduced when mopping.
- It is recommended to wash the mop cloth after each use.

1. Remove the mop cloth mount.

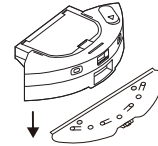

2. Empty the water tank.

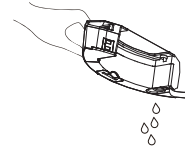

3. Remove the washable mop cloth.

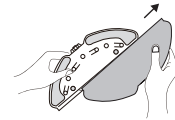

4. Clean the mop cloth.

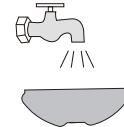

5. Sun dry mop cloth and mop cloth mount.

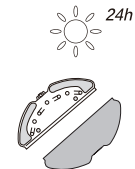

## 8 Care and Maintenance

To maintain optimal performance, maintain the robot vacuum according to the following guidelines.

Part	Maintenance Frequency	Replacement Frequency*
Dustbin	Clean/wash as needed	/
Filter	Once a week	3-6 months
Main Brush	Every 2 weeks	6-12 months
Side Brush	Once a month	3-6 months
Dust Bag	/	Replaced when it is full
Mop Cloth	After each use	2-3 months
Caster Wheel	Clean as needed	/
Main Wheels	Once a month	/
Sensors	Once a month	/
Charging Contacts	Once a month	/

\*Replacement frequency may vary depending on the actual situation. Parts should be replaced if visible wear appears.

# Empty the Bin

1. Remove the dustbin and water tank.

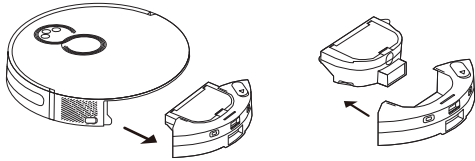

2. Open the dustbin to empty the dustbin.



3. Place the dustbin back inside the robot vacuum.

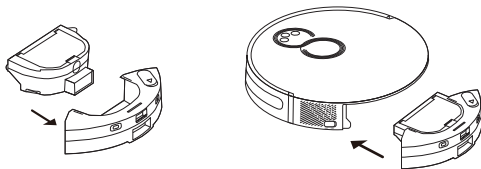

# Clean the Filter

1. Remove the dustbin and open the lid.

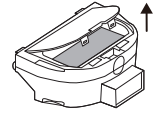

2. Remove the filter.



3. Clean the filter with a cleaning brush.

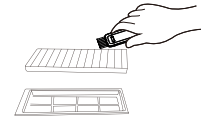

4. Wash the dustbin and filter.

■ Do not wash with hot water or detergents.

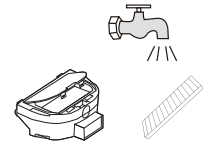

5. Air-dry the dustbin and filter thoroughly, then install the filter in the previous orientation.

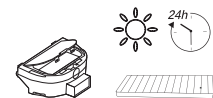



## Clean the Main Brush

1. Turn the robot vacuum over, then unlatch and remove the main brush cover.

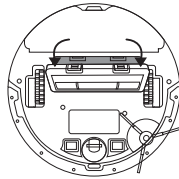

2. Remove the brush and its end cap.

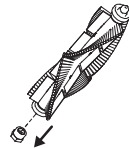

3. Remove any hair or debris with the cleaning brush.

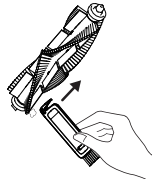

4. Re-install the cap and main brush. Press on the main brush cover to lock it in place.

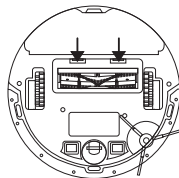

## Clean the Side Brush

1. Pull firmly to remove the side brush and remove any entangled debris. Wipe with a damp cloth if needed.

2. Re-install the side brush and press it tightly to ensure it is installed in place.

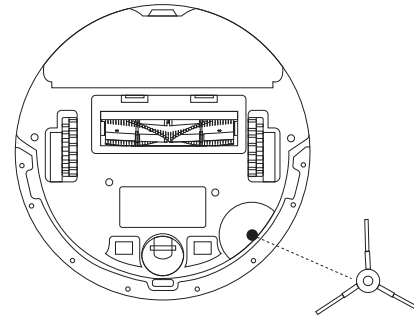

# Clean the Caster Wheel

1. Pull firmly to remove the caster wheel and remove hair or dirt.
2. Re-install the caster wheel and press it firmly in place.

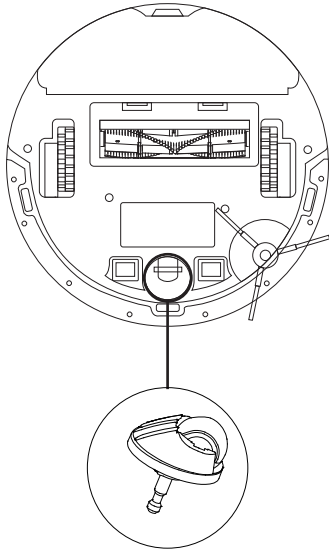

# Clean Main Wheels

Wipe main wheels with a clean, dry cloth.

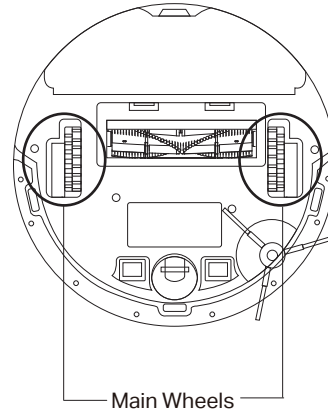

# Clean the Sensors

Wipe the sensors with a clean, dry cloth.

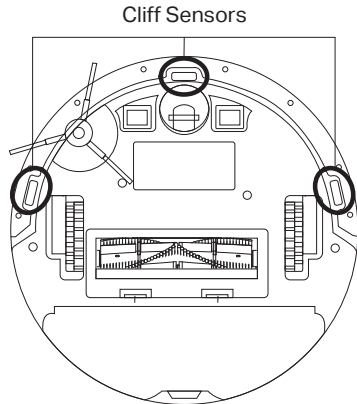
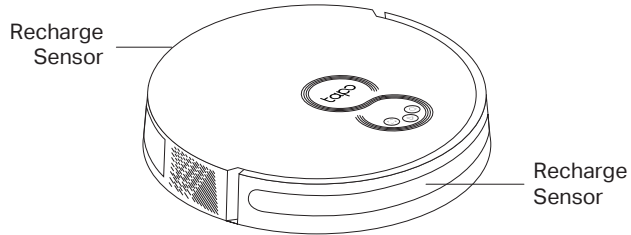

# Clean the Charging Contacts

Wipe the charging contacts with a clean, dry cloth.

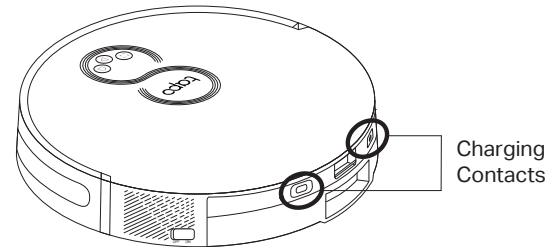
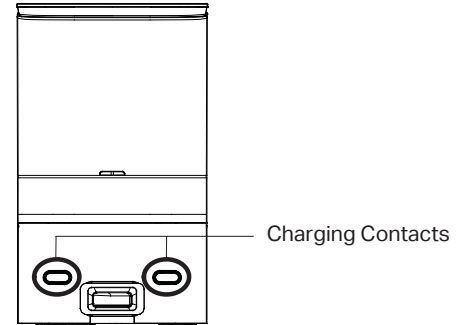

# Replace the Bag

1. Open the top cover and pull up the handle of the dust bag to remove.

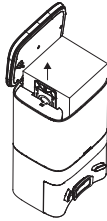

2. Throw away the used dust bag.

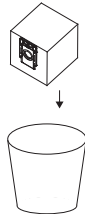

3. Install a new dust bag and put the cover back on.

Put the cover back on each time you open it.

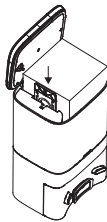

# Clean Up the Dust Channel

If the LED flashes red after replacing the dust bag, please check if the dust channel is blocked by foreign objects. If the dust channel is blocked, use a screwdriver to remove the transparent cover of the dust channel, and clean out foreign objects.

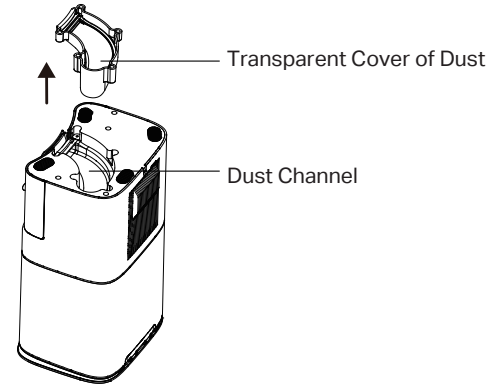



## 9 Troubleshooting

Issues	Solution
Setup failure	<ol style="list-style-type: none"><li>1. Check if the power switch on the left side of the robot vacuum is toggled to "ON".</li><li>2. The battery level is low. Please place the robot vacuum on the dock to charge and it will start automatically when it is ready.</li><li>3. Check your internet connection or check if you have configured Allow List or Firewall settings on your router.</li></ol>
Charging failure	<ol style="list-style-type: none"><li>1. Please remove the robot vacuum and check whether the indicator light of the dock is on, and make sure that the power adapter of the dock are plugged in.</li><li>2. Poor contact. Please clean up the spring contacts on the dock and the charging contacts on the robot vacuum.</li></ol>
Recharge failure	<ol style="list-style-type: none"><li>1. There are many obstacles near the dock. Please place the dock in an open area and try again.</li><li>2. The robot vacuum is far from the dock. Please place the robot vacuum near the dock and try again.</li><li>3. Please clean up the spring contacts on the dock and the recharge sensor/charging contacts on the robot vacuum.</li></ol>
Abnormal operation	Shut down and try again.
Abnormal noise during cleaning	There may be foreign matter entangled in the main brush, side brush or wheels. Please clean up after shutdown.
Decreased cleaning ability or dust leakage	<ol style="list-style-type: none"><li>1. The dustbin is full. Please clean the dustbin.</li><li>2. The filter is clogged. Please clean or replace the filter.</li><li>3. The main brush is entangled by foreign matter. Please clean the main brush.</li></ol>
Failure to connect to Wi-Fi	<ol style="list-style-type: none"><li>1. The Wi-Fi signal is poor. Please make sure the robot vacuum is in an area with good Wi-Fi signals.</li><li>2. Wi-Fi connection is abnormal. Please reset the Wi-Fi and download the latest app and try again.</li><li>3. The password is entered incorrectly. Please check.</li><li>4. The robot vacuum only supports the 2.4 GHz frequency band. Please connect to a 2.4 GHz Wi-Fi.</li></ol>
Scheduled cleaning doesn't work	<ol style="list-style-type: none"><li>1. The battery level is low. The scheduled cleaning will work when the battery level is above 20%.</li><li>2. The cleaning is already in progress when the schedule starts.</li><li>3. Do Not Disturb is set in the app. Make sure the schedule is not within the set Do Not Disturb period.</li><li>4. There is no internet access for your Wi-Fi network and your robot vacuum has restarted.</li></ol>

Issues	Solution
Whether the robot vacuum consumes power when it is placed on the dock	The power consumption is very low when the robot vacuum is placed on the dock, which helps the battery to maintain optimal performance.
Whether the robot vacuum needs to be charged for 16 hours for the first three times	Lithium battery has no memory effect when in use, and there is no need to wait when it is fully charged.
After the robot vacuum returns to the dock, automatic dust collection does not start.	<ol style="list-style-type: none"> <li>1. Please check if the dock is powered on. Automatic dust collection will not start until the robot vacuum has cleaning for more than 30 minutes in total.</li> <li>2. Dust collection is too frequent (more than 3 times in 10 minutes).</li> <li>3. Do Not Disturb is set in the app. The robot vacuum will not automatically collect dust during the Do Not Disturb period.</li> <li>4. Please check if the cover of the dock is closed properly. If not, the red light will be on.</li> <li>5. Please check if a dust bag is installed properly. If not installed or improperly installed, the red light will be on.</li> <li>6. To ensure smooth dust collection, it is recommended to let the robot vacuum recharge automatically after cleaning. Manually moving the robot vacuum back to the dock may cause unstable connection.</li> <li>7. Please check the dust bag regularly to see if it is full, because overloaded dust bag may break, block the dust collection pipe and cause damage to the dock.</li> <li>8. If the problem persists, the components may be abnormal. Please contact the technical support.</li> </ol>
Automatic dust collection is interrupted after startup or dust collection is not thorough.	<ol style="list-style-type: none"> <li>1. Check if the dust bag is full. If the dust bag is full, replace it.</li> <li>2. The dust collection part of the robot vacuum is jammed by foreign objects, causing the dust box baffle to fail to open.</li> <li>3. Check if the dust channel of the dock is blocked.</li> <li>4. Please do not move the robot vacuum during dust collection for fear of damage.</li> <li>5. There may be water in the dust box of the robot vacuum, so that dust can not be extracted easily. Please try to prevent the robot vacuum extracting excessive water, which will affect the dust collection performance.</li> </ol>
The interior of the dock is dirty.	<ol style="list-style-type: none"> <li>1. Fine particles will pass through the dust bag and be adsorbed on the inner wall of the dock. Please check and clean up them regularly.</li> <li>2. The dust bag may be damaged. Please check and replace if necessary.</li> <li>3. Severe dirt accumulation in the inner chamber has a certain impact on the fan and air pressure sensor. It is recommended to clean up the interior of the dust container regularly.</li> </ol>

 If the corresponding issues cannot be solved by referring to the above methods, please contact our Technical Support.

# Energy Saving Mode

When the robot vacuum is docked, press and hold the Power button  and the Dock button  for about 15 seconds until you hear an alert sound. It will also enter the Energy Saving mode when it is fully charged.

In this mode, only the charging feature will work. Other functions will not work, such as LEDs will be off, sensors will not work, and Wi-Fi will be disconnected.

To exit the Energy Saving mode, press any button on the robot vacuum.



## **Need some help?**

**Visit [www.tapo.com/support/](http://www.tapo.com/support/)**

for technical support, user guides, FAQs, warranty & more