



User Guide

Outdoor Pan/Tilt 4G LTE Camera

Contents

About This Guide	1
Introduction	2
Appearance	3
Set Up Your Camera	5
Install a microSD Card	7
Mount Your Camera	8
Install Waterproof Accessories	11
Authentication	13

About This Guide

This guide provides a brief introduction to the Outdoor Pan/Tilt 4G LTE Camera and the Tapo app, as well as regulatory information.

Please note that features available in Tapo may vary by model and software version. Tapo availability may also vary by region. All images, steps, and descriptions in this guide are only examples and may not reflect your actual Tapo Camera experience.

Conventions

In this guide, the following convention is used:

Convention	Description
Blue	Key information appears in blue, including management page text such as menus, items, buttons and so on.
<u>Underline</u>	Hyperlinks are in blue and underlined. You can click to redirect to a website.
■ Note:	Ignoring this type of note might result in a malfunction or damage to the device.

More Info

- Specifications can be found on the product page at <https://www.tapo.com>.
- Our Technical Support and troubleshooting information can be found at <https://www.tapo.com/support/>.
- The setup video can be found at <https://www.tp-link.com/support/setup-video/#cloud-cameras>.

Introduction

Tapo C501GW is an outdoor pan/tilt 4G LTE camera that offers all-round protection without Wi-Fi. It can access the internet through 4G LTE networks or the RJ45 Ethernet port, which is suitable for places like warehouses, farms, and vacation homes where constant Wi-Fi may be unavailable.

- **Advanced AI Detection for All Scenarios** – Smart AI identifies people, pets, and vehicles and detects tampering and line crossing. It sends alerts only when necessary, ensuring you receive precise notifications about events as they occur.
- **Starlight Color Night Vision** – Reveals vivid colors in low light conditions with F1.6 aperture lens, starlight sensor, and built-in spotlights.
- **Patrol Mode** – Keep the camera cruise between two customized points for dynamic monitoring.
- **Local* and Cloud** Storage** – Save recorded videos to an installed microSD card (up to 512 GB)*, or use Tapo Care** cloud storage service.
*microSD card must be purchased separately.
**Subscribe for cloud storage at <https://www.tapo.com/tapocare/>
- **DC/PoE Power Supply*** – Power your camera with a DC adapter or Ethernet cable featuring PoE technology for safe power and stable internet.
*802.3 af/at PoE (Power over Ethernet)
The maximum length for the PoE connection is 100 meters (328 feet).
- **Flexible Antenna Placement** – Adjust the angle of the detachable antenna for a better internet connection.
- **Smart Playback** – Swiftly find and download moments of interest by choosing the event type or sliding the timeline.
- **Two-Way Audio** – Communicate remotely with a delivery person in real time.
- **Multiple Installation Options** – Use the mounting screws, template and loops* to install on any wall, ceiling or pole for the perfect view.
*Mounting loops purchased separately.

Appearance

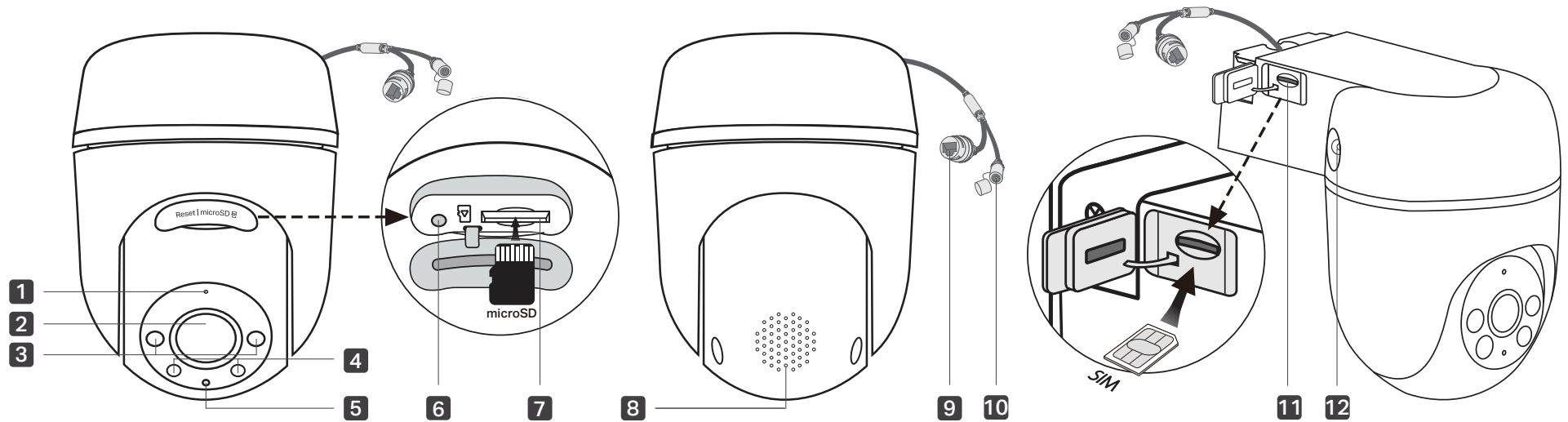

- | | | | |
|---------------------|---------------------------|--|--------------------------------|
| 1 Microphone | 4 White Light LEDs | 7 microSD Card Slot | 10 DC Power Connector |
| 2 Lens | 5 System LED | 8 Speaker | 11 Nano SIM Card Slot |
| 3 IR LEDs | 6 Reset | 9 Ethernet Port (PoE Connector) | 12 SMA Female Connector |

Reset Button

Open the silicone cover. While the camera is powered on, use a pin to press and hold the RESET button for at least 5 seconds until the System LED blinks red. The camera will reset and reboot.

microSD Card Slot

Open the silicone cover and insert a microSD card*. Initialize it on the Tapo app for local recording.
*microSD card not included.

Nano SIM Card Slot

Open the silicone cover and insert a Nano SIM card for a 4G network connection.

System LED Indication

Solid red	Starting up
Blinking red and green	Unstable 4G signal
Blinking red	Neither a SIM card nor an Ethernet cable inserted
Blinking amber (for 4G setup)	Connecting to the network
Solid amber	Connected to the network
Solid green	Connected to the cloud
Blinking red quickly	Camera resetting
Blinking green quickly	Camera updating

Set Up Your Camera

Follow the steps below to get started with your new camera.

Step 1. Download Tapo App

Get the Tapo app from the App Store or Google Play, or by scanning the QR code below.



OR



Step 2. Log In

Open the app, and log in with your TP-Link ID. If you don't have an account, create one first.

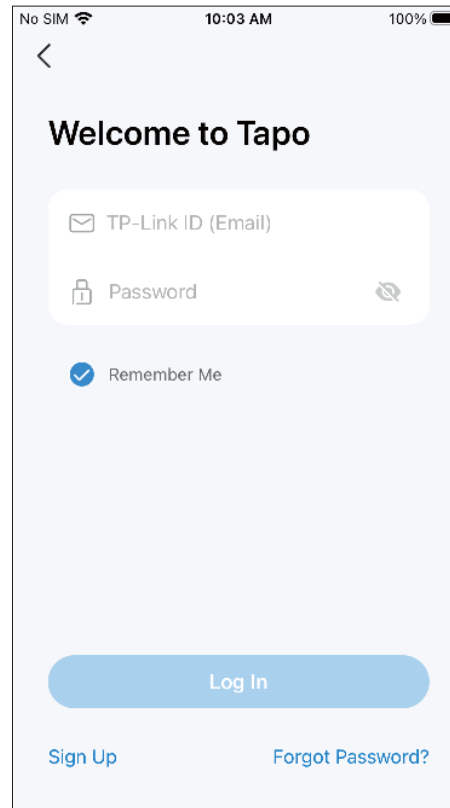

Step 3. Add Your Camera

Tap the ⊕ button > Add Device in the app and search for your model.

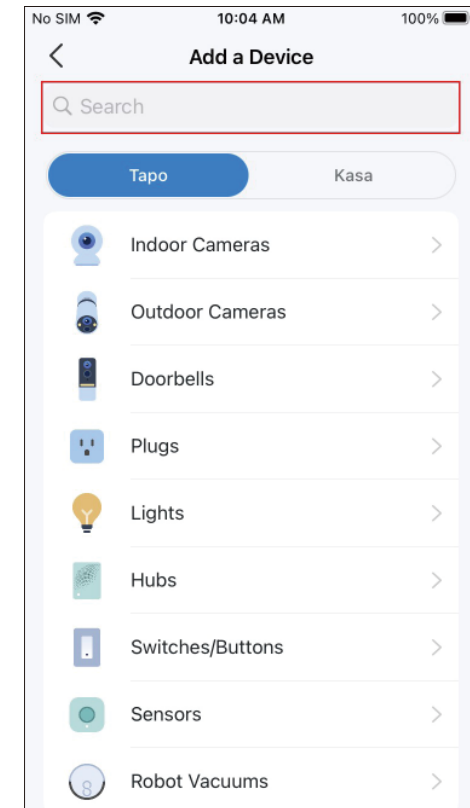

Step 4. Configure Camera

Follow app instructions to set up your camera via 4G or wired connection, and add it to your home network. After setup, you can use your camera via wired or 4G connection.

■Note: For 4G setup, if your camera is connected to your router via an Ethernet cable, please unplug the cable first.

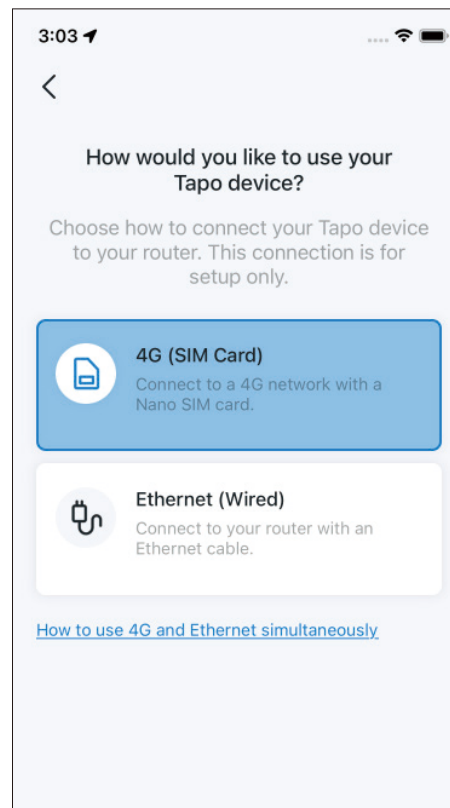

Install a microSD Card

Follow the steps below to install the microSD card for local recording.

You can go to [Camera Settings](#) > [microSD Card](#) in the Tapo app to check the card status or format your card.

1. Manually rotate the camera downwards. Open the silicone cover to find the microSD card slot.

2. Identify the direction of the microSD card and carefully insert the card into the slot. Push in the card until you hear a clicking sound.

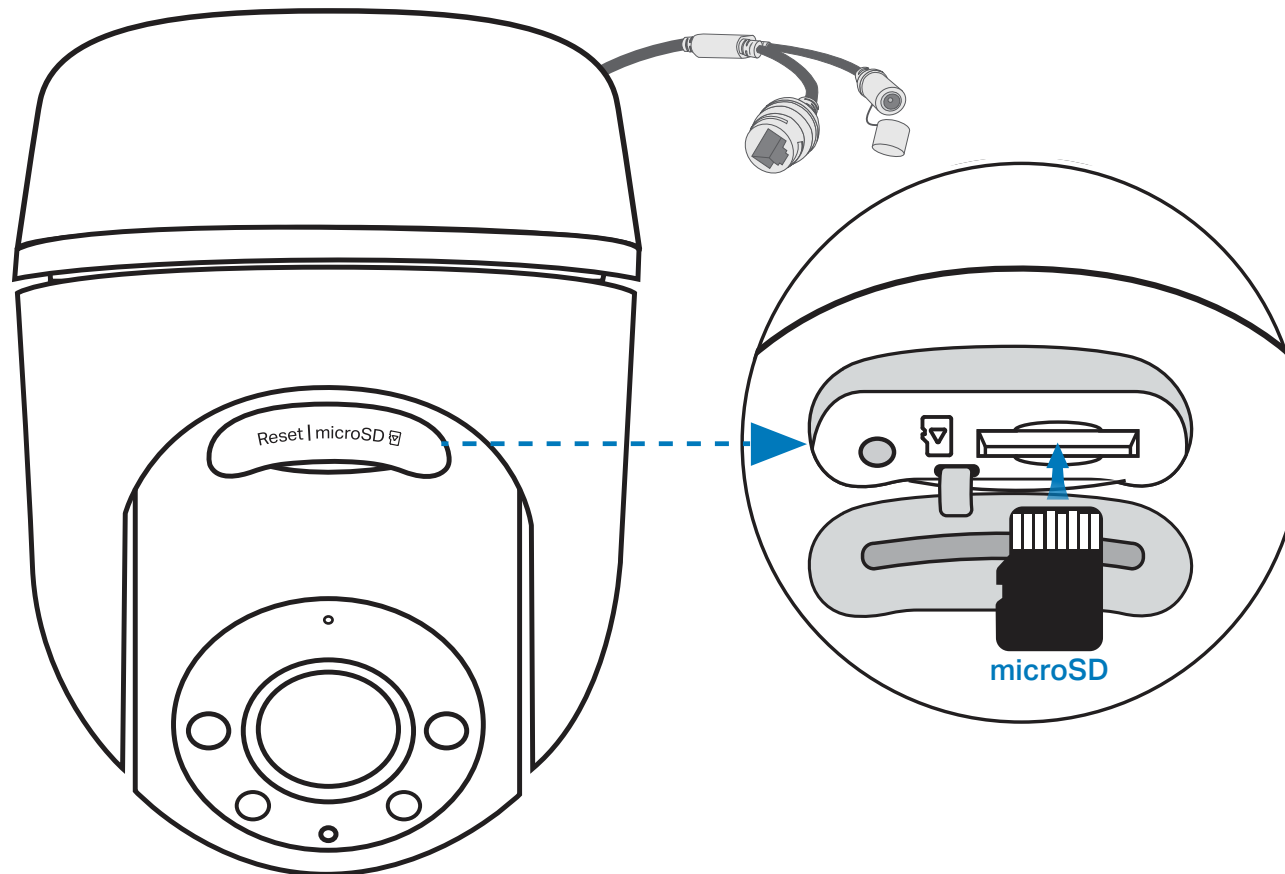

Mount Your Camera

When you finish adding your camera in the Tapo app, you can mount it on a wall or ceiling with the provided mounting template and screws. You can also mount it on the pole with mounting loops. Follow the steps below to mount your new camera.

■ **Note:** The camera is not waterproof when set on a table or shelf. Mount the camera via Option 1-3 when installing outdoors.



Option 1: Wall Mount

1. Affix the Camera and Bracket

Route the camera power cord and Ethernet cable through the opening of the bracket. Use two bracket screws to affix the bracket and camera.

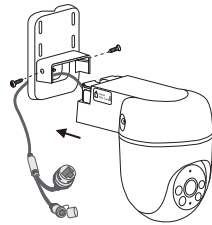

3. Mount the Camera

Insert four mounting anchors into the holes, then use the mounting screws to affix the camera and bracket over the anchors.

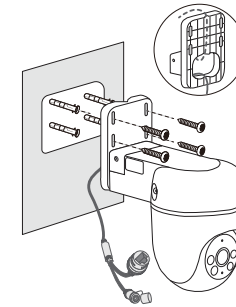
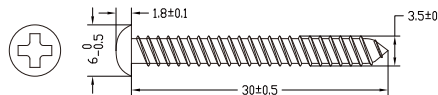

2. Drill Holes

Stick the mounting template to the desired mounting place. Drill four screw holes according to the template.

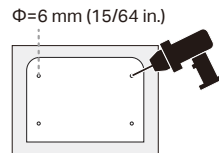

4. Install the Antenna

- 1) Rotate the antenna **clockwise** to attach it.
- 2) Rotate the SMA connector **clockwise** to tighten the antenna.
- 3) Adjust the antenna vertically for the best 4G signal.
- 4) Re-tighten the connector in case the antenna is loose.

Note: For the cable connection, ensure the antenna is properly installed for waterproof performance.

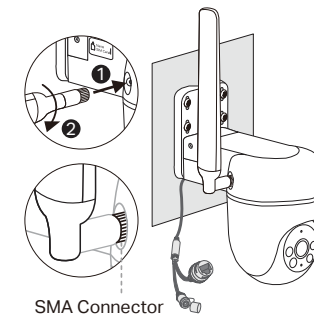

Option 2: Overhang Mount

1. Affix the Camera and Bracket

Route the camera power cord and Ethernet cable through the opening of the bracket. Use two bracket screws to affix the bracket and camera.

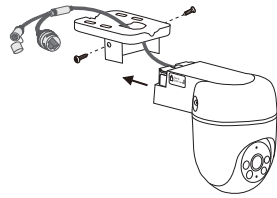

2. Drill Holes

Stick the mounting template to the desired mounting place. Drill four screw holes according to the template.

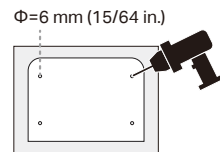

3. Mount the Camera

Insert four mounting anchors into the holes, then use the mounting screws to affix the camera and bracket over the anchors.

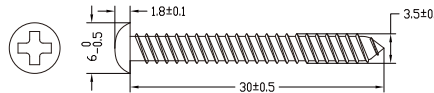

4. Install the Antenna

- 1) Rotate the antenna **clockwise** to attach it.
- 2) Rotate the SMA connector **clockwise** to tighten the antenna.
- 3) Adjust the antenna to either an acute angle or horizontal with the ceiling for the best 4G signal.
- 4) Re-tighten the connector in case the antenna is loose.

Note: For the cable connection, ensure the antenna is properly installed for waterproof performance.

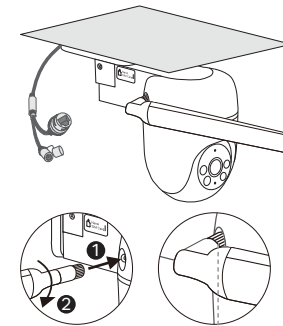
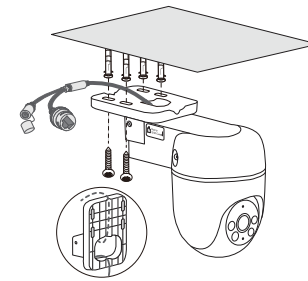

SMA Connector

Option 3: Pole Mount

1. Affix the Camera and Bracket

Route the camera power cord and Ethernet cable through the opening of the bracket. Use two bracket screws to affix the bracket and camera.

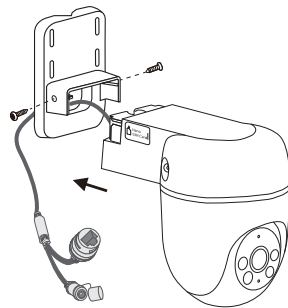

2. Mount the Camera

Mount the camera on the pole using two pole-mounting loops* (loop width $\leq 12\text{mm}$).

*Pole-mounting loops are not included.

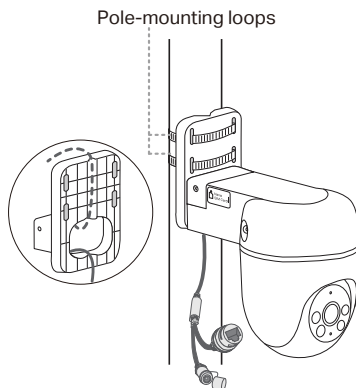

3. Install the Antenna

- 1) Rotate the antenna **clockwise** to attach it.
- 2) Rotate the SMA connector **clockwise** to tighten the antenna.
- 3) Adjust the antenna vertically for the best 4G signal.
- 4) Re-tighten the connector in case the antenna is loose.

Note: For the cable connection, ensure the antenna is properly installed for waterproof performance.

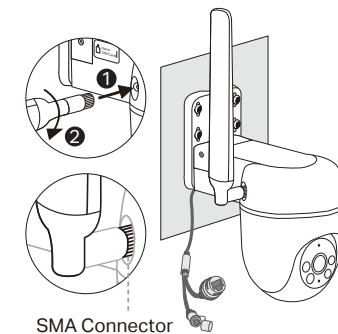

Install Waterproof Accessories

When the camera is installed outdoors, please install waterproof accessories to waterproof your camera as follows.

1. Install the Waterproof Seal/Cap for Power Connectors

Connect the camera to a power outlet using the provided power adapter. Install the waterproof seal for the power connectors when the camera is installed outdoors.

➤ When powered by the adapter

Install the waterproof seal for the power connectors.

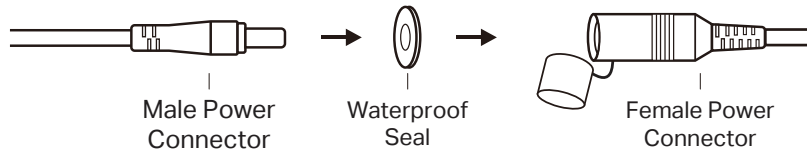

➤ When powered by PoE

Use the waterproof cap to cover the power connector.



2. Install Waterproof Cable Attachments

Install the waterproof cable attachments for the network interface. Make sure each part is securely attached and the waterproof rings are flush to keep out water.

➤ When the Ethernet port connects to a network device

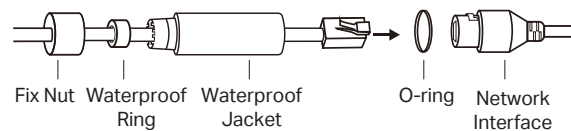

- 1) Route the network cable through the following components in order: fix nut, waterproof ring, and then the waterproof jacket.
- 2) Insert the waterproof ring into the waterproof jacket.
- 3) Fix the O-ring to the network interface of the camera and connect the network cables.
- 4) Attach the network interface with the waterproof jacket, then twist to lock. Rotate the fix nut to secure it to the waterproof jacket.

➤ When the Ethernet port does not connect to a network device

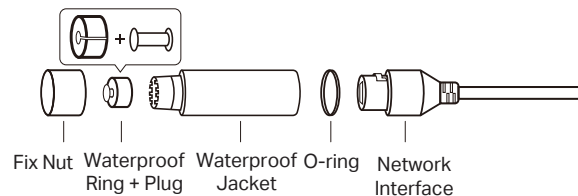

- 1) Insert the waterproof plug into the waterproof ring, then insert them into the waterproof jacket.
- 2) Fix the O-ring to the network interface of the camera. Attach the network interface with the waterproof jacket, then twist to lock. Rotate the fix nut to secure it to the waterproof jacket.

Authentication

CE Mark Warning



This is a class B product. In a domestic environment, this product may cause radio interference, in which case the user may be required to take adequate measures.

OPERATING FREQUENCY (the maximum transmitted power)

LTE-FDD B1/B3/B5/B7/B8/B20/B28 (23 dBm)

LTE-TDD B38/B40/B41 (23 dBm)

WCDMA B1/B5/B8 (24 dBm)

EU Declaration of Conformity

TP-Link hereby declares that the device is in compliance with the essential requirements and other relevant provisions of directives 2014/53/EU, 2009/125/EC, 2011/65/EU and (EU)2015/863.

The original EU Declaration of Conformity may be found at <https://www.tapo.com/en/support/ce/>.

RF Exposure Information

This device meets the EU requirements (2014/53/EU Article 3.1a) on the limitation of exposure of the general public to electromagnetic fields by way of health protection.

The device complies with RF specifications when the device used at 20 cm from your body.

UKCA Mark



UK Declaration of Conformity

TP-Link hereby declares that the device is in compliance with the essential requirements and other relevant provisions of the Radio Equipment Regulations 2017.

The original UK Declaration of Conformity may be found at <https://www.tapo.com/support/ukca/>.



Korea Warning Statements:

당해 무선설비는 운용중 전파혼신 가능성이 있음.

NCC Notice & BSMI Notice

注意!

取得審驗證明之低功率射頻器材，非經核准，公司、商號或使用者均不得擅自變更頻率、加大功率或變更原設計之特性及功能。

低功率射頻器材之使用不得影響飛航安全及干擾合法通信；經發現有干擾現象時，應立即停用，並改善至無干擾時方得繼續使用。

前述合法通信，指依電信管理法規定作業之無線電通信。

低功率射頻器材須忍受合法通信或工業、科學及醫療用電波輻射性電機設備之干擾。

為避免本器材影像畫面遭偷窺或擷取，本器材使用者應先修改預設密碼，並定期更新密碼。

安全諮詢及注意事項

- 請使用原裝電源供應器或只能按照本產品注明的電源類型使用本產品。
- 清潔本產品之前請先拔掉電源線。請勿使用液體、噴霧清潔劑或濕布進行清潔。
- 注意防潮，請勿將水或其他液體潑灑到本產品上。
- 插槽與開口供通風使用，以確保本產品的操作可靠並防止過熱，請勿堵塞或覆蓋開口。
- 請勿將本產品置放於靠近熱源的地方。除非有正常的通風，否則不可放在密閉位置中。
- 不要私自拆開機殼或自行維修，如產品有故障請與原廠或代理商聯繫。
- 電源供應器應使用在環境溫度低於或等於40°C的室內。

限用物質含有情況標示聲明書

設備名稱：Outdoor Pan/Tilt 4G LTE Camera			型號（型式）：Tapo C501GW			
Equipment name			Type designation (Type)			
單元 Unit	限用物質及其化學符號 Restricted substances and its chemical symbols					
	鉛 Lead (Pb)	汞 Mercury (Hg)	鎘 Cadmium (Cd)	六價鉻 Hexavalent chromium (Cr ⁺⁶)	多溴聯苯 Polybrominated biphenyls (PBB)	多溴二苯醚 Polybrominated diphenyl ethers (PBDE)
PCB	○	○	○	○	○	○

外殼	○	○	○	○	○	○
電源供應器	—	○	○	○	○	○
其他及其 配件	—	○	○	○	○	○

備考 1. “超出 0.1 wt %” 及 “超出 0.01 wt %” 係指限用物質之百分比含量超出百分比含量基準值

Note 1: “Exceeding 0.1 wt %” and “exceeding 0.01 wt %” indicate that the percentage content of the restricted substance exceeds the reference percentage value of presence condition.

備考 2. “○” 係指該項限用物質之百分比含量未超出百分比含量基準值。

Note 2: “○” indicates that the percentage content of the restricted substance does not exceed the percentage of reference value of presence.

備考 3. “—” 係指該項限用物質為排除項目。

Note 3: The “—” indicates that the restricted substance corresponds to the exemption.



Продукт сертифіковано згідно с правилами системи УкрСЕПРО на відповідність вимогам нормативних документів та вимогам, що передбачені чинними законодавчими актами України.















Safety Information











- Do not use damaged charger or USB cable to charge the device.
- Do not use any other chargers than those recommended.
- Do not use the device where wireless devices are not allowed.
- Adapter shall be easily accessible.
- Use only power supplies which are provided by manufacturer and in the original packing of this product. If you have any questions, please don't hesitate to contact us.
- Keep the device away from fire or hot environments. DO NOT immerse in water or any other liquid.
- Do not disassemble, repair or modify the product.
- Do not use the product if the casing has been broken. Danger of electric shock.
- Never touch the product with wet hands.
- Do not place near automatically controlled devices such as fire alarms. Radio waves emitted from this product may cause such devices to malfunction resulting in an accident.
- Observe restrictions on using wireless products in fuel depots, chemical plants or when blasting operations are in progress.
- Do not use liquid to clean the product. Only use a dry cloth.
- Never put metal objects inside the product. If a metal object enters the product turn off the circuit breaker and contact an authorised electrician.
- This product is not intended to be used when providing medical care. Consult the manufacturer of any personal medical devices, such as pacemakers or hearing aids to determine if they are adequately shielded from external RF (radio frequency) energy.
- Do not use this product in health care facilities. Hospitals or health care facilities may be using equipment that could be sensitive to external RF energy.
- Do not place heavy objects on top of the product.
- When you leave the product unused for a long time unplug the product from the power outlet.
- This product may interfere with other electronic products such as TV, radios, personal computers, phones or other wireless devices.
- Adapter should be used indoors where the ambient temperature is lower than or equal to 40 °C.
- Operating Temperature: -30 °C ~ 60 °C (-22 °F ~ 140 °F)

Please read and follow the above safety information when operating the device. We cannot guarantee that no accidents or damage will occur due to improper use of the device. Please use this product with care and operate at your own risk.

Explanation of the symbols on the product label

Symbols may vary from products

Symbol	Explanation
	Class II equipment
	Class II equipment with functional earthing
	Alternating current
	DC voltage
	Polarity of output terminals
	Indoor use only
	Dangerous voltage
	Caution, risk of electric shock
	Energy efficiency Marking
	Protective earth
	Earth
	Frame or chassis

Symbol	Explanation
	Functional earthing
	Caution, hot surface
	Caution
	Operator's manual
	Stand-by
	"ON"/"OFF" (push-push)
	Fuse
	Fuse is used in neutral N
	<p>RECYCLING</p> <p>This product bears the selective sorting symbol for Waste electrical and electronic equipment (WEEE). This means that this product must be handled pursuant to European directive 2012/19/EU in order to be recycled or dismantled to minimize its impact on the environment.</p> <p>User has the choice to give his product to a competent recycling organization or to the retailer when he buys a new electrical or electronic equipment.</p>
	Caution, avoid listening at high volume levels for long periods
	Disconnection, all power plugs

Symbol	Explanation
m	Switch of mini-gap construction
μ	Switch of micro-gap construction (for US version) Switch of micro-gap / micro-disconnection construction (for other versions except US)
ε	Switch without contact gap (Semiconductor switching device)