



Installation Guide

Outdoor Access Point

CONTENTS

Deutsch	1
English.....	6
Español.....	11
Ελληνικά	16
Français.....	21
Italiano	26
Português	31
Suomi	36
Nederlands	41
Svenska.....	46
Norsk	51
Dansk	56

Hinweis: Die Bilder können vom tatsächlichen Aussehen des Produkts abweichen.

Typische Netztopologie

■ Für den EAP

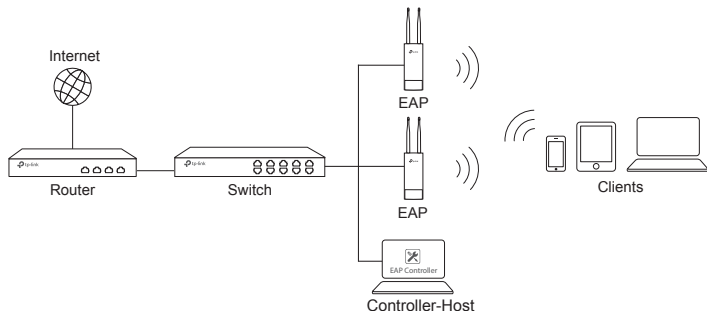

Ein Computer, auf dem die EAP-Controller-Software läuft, egal ob im selben Netzsegment oder einem anderen, steuert die EAPs zentral.

Der EAP-Controller kann auf www.tp-link.de heruntergeladen werden.

■ Für den CAP (FIT-Modus)

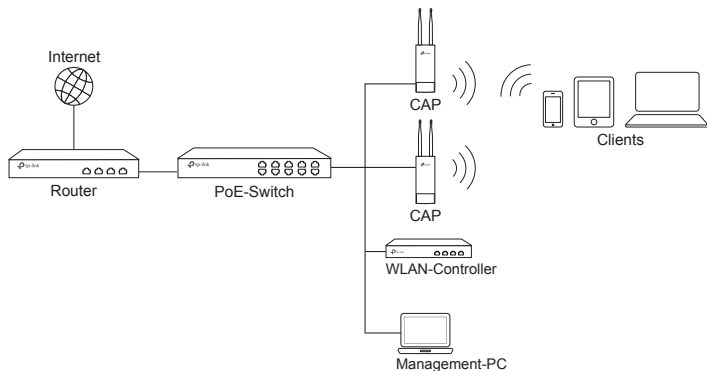

Der WLAN-Controller kann sich im selben Netzsegment oder einem anderen als die CAPs befinden. Der Management-PC wird verwendet, um sich zwecks Verwaltung der CAPs in den Controller einzuloggen.

Hardwareinstallation

Der Accesspoint kann an einen Mast oder an eine Wand montiert werden.

■ Option 1: Mastmontage

- 1 Lösen und entfernen Sie das Ende der Metallschelle komplett, indem Sie die Schraube mit einem flachen Schraubenzieher entgegen dem Uhrzeigersinn drehen.

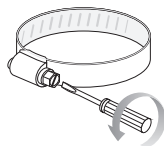

- 2 Führen Sie die Metalllasche durch die Öffnungen hinten am Gehäuse des Accesspoints.

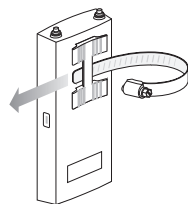

- 3 Positionieren Sie den Accesspoint und legen Sie die Schelle um den Mast. Führen Sie das Ende in den Schraubenblock und drehen Sie die Schraube mit einem flachen Schraubenzieher im Uhrzeigersinn, bis der Accesspoint fest sitzt.

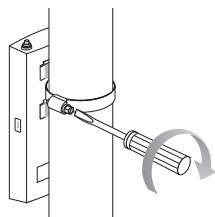

- 4 Verbinden Sie die Antennen mit dem Accesspoint.

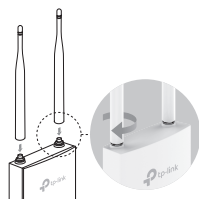

■ Option 2: Wandmontage

- 1 Plazieren Sie die Halterung wie gewünscht. Markieren Sie die Positionen der drei Bohrlöcher. Bohren Sie an den markierten Stellen drei 6mm-Löcher für die Schrauben.

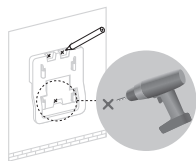

- 2 Führen Sie die Dübel in die 6mm-Löcher ein. Richten Sie die Halterung aus und bringen Sie die Schrauben an.

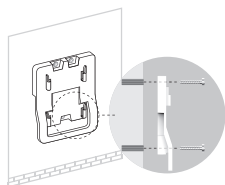

- 3 Richten Sie die Halterungen auf der Rückseite des Accesspoints an der montierten Halterung aus. Bringen Sie den Accesspoint in Position, bis er einrastet.

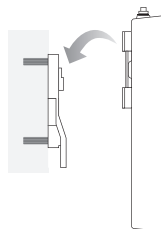

- 4 Verbinden Sie die Antennen mit dem Accesspoint.

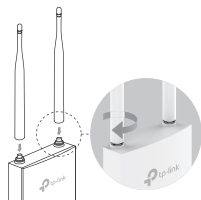

Kabelanschluss

- 1 Ziehen Sie die Schnittstellenabdeckung auf der Rückseite des Gerätes nach unten.



- 2 Verbinden Sie den LAN-Port mit einem passenden Ethernetkabel. Abgeschirmte, geerdete CAT5e-Kabel (oder höher) werden empfohlen.



- 3 Fixieren Sie die Gummidichtung unten am Gerät und bringen Sie die Abdeckung wieder an.

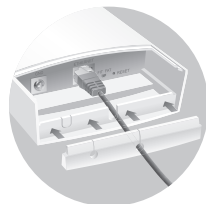

Spannungsversorgung

■ Speisung des CAPs über einen PoE-Switch

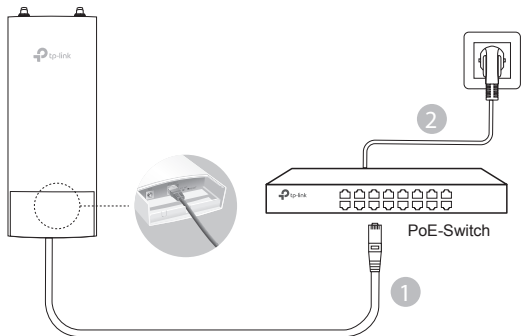

■ Speisung des CAPs über einen PoE-Adapter

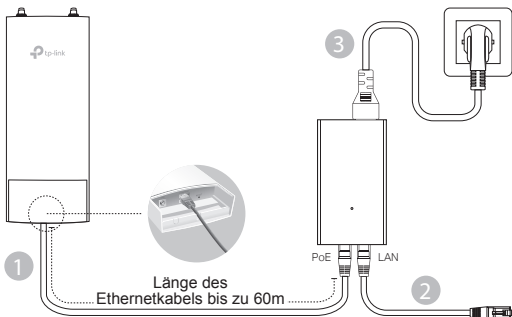

Note: The image may differ from the actual product.

Typical Network Topology

■ For the EAP

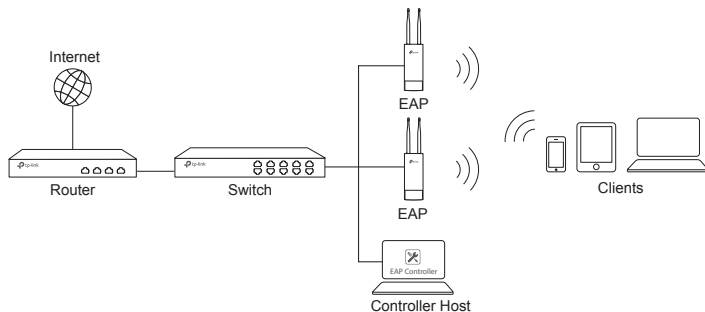

A computer running the EAP Controller software, which can be in the same or different subnet with the EAPs, is used to centrally manage the EAPs.

You can get the EAP Controller software from our website <http://www.tp-link.com>.

■ For the CAP (FIT Mode)

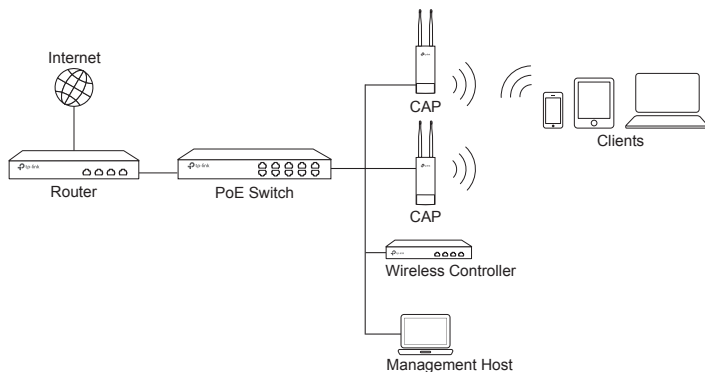

The wireless controller can be in the same or different subnet with the CAPs. And the management host is used to log in to the wireless controller to centrally manage the CAPs.

Hardware Installation

The Access Point can be pole-mounted or wall-mounted.

■ Option1: Pole Mounting

- 1 Loosen and completely remove the end of the metal strap by turning the captive screw counterclockwise with a flathead screwdriver.

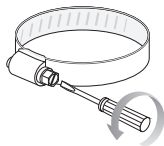

- 2 Lead the end of the metal strap through the back of the Access Point.

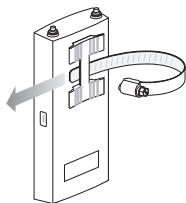

- 3 Position the Access Point and wrap the metal strap around the pole. Feed the end back through the screw-block and turn the screw clockwise to tighten the metal strap using a flathead screwdriver until the Access Point is secure.

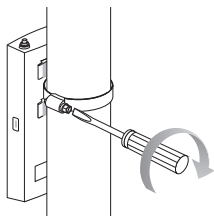

- 4 Connect the antennas to the Access Point.

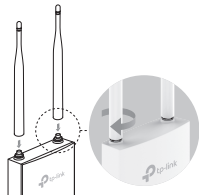

■ Option2: Wall Mounting

- 1 Place the mounting bracket in the position you require. Mark three positions for the screw holes. Drill three 6mm (in diameter) holes at the marked positions.

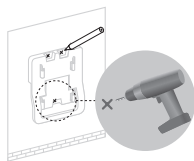

- 2 Insert the plastic wall anchors into the 6mm holes. Align the bracket to the plastic wall anchors and drive the self-tapping screws into the anchors through the bracket.

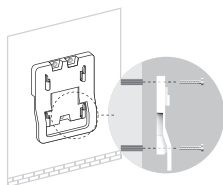

- 3 Align the mounting tabs on the back of the Access Point with the four slots of the mounting bracket. Push and slide the Access Point downward until it locks into place.

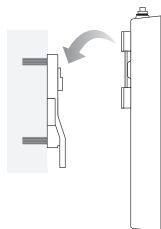

- 4 Connect the antennas to the Access Point.

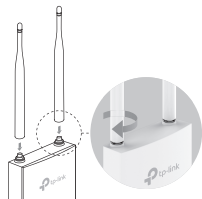

Connect Cables

- 1 Firmly grasp the rear of the interface cover and pull it downward.



- 2 Use an adequate Ethernet cable to connect the LAN port. Shielded CAT5e (or above) cable with an integrated ground wire is recommended.



- 3 Affix the waterproof rubber insert to the underside of the device for waterproofing and replace the cover until it firmly locks into place.

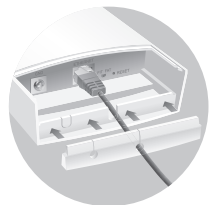

Power Supply

■ Power the CAP via PoE Switch

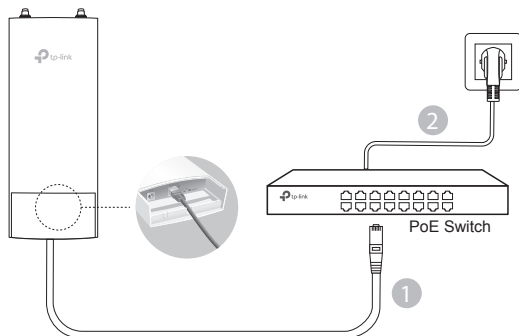

■ Power the EAP via PoE Adapter

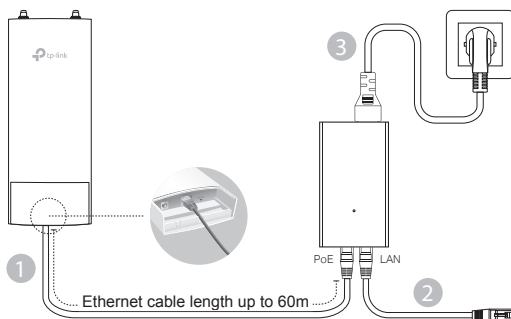

Nota: La imagen puede cambiar respecto al producto actual.

Topología de Red Típica

■ Para el EAP

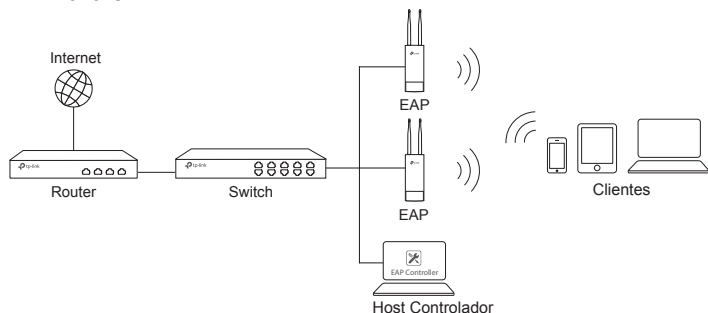

Ordenador con el software Controlador EAP funcionando, que puede estar en la misma o diferente subred que los EAPs, se utiliza como gestión centralizada de EAPs.

Puede obtener el software Controlador EAP en nuestra página web:
<http://www.tp-link.es>

■ Para el CAP (Modo FIT)

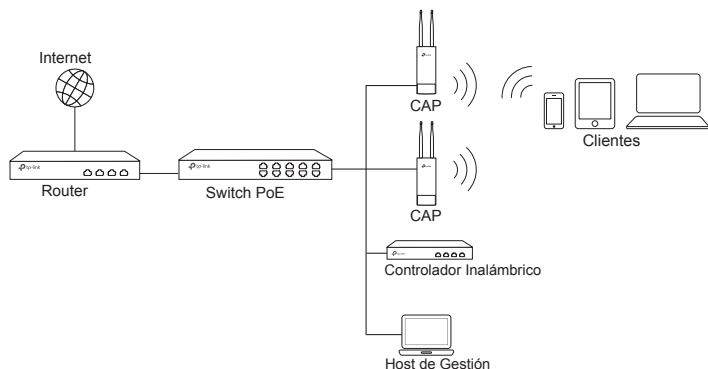

El controlador inalámbrico puede estar en la misma o diferente subred que los CAPs. El host de gestión se utiliza para acceder al controlador inalámbrico para gestionar de manera centralizada los CAPs.

Instalación de Hardware

El Punto de Acceso puede ser con montaje en mástil o de pared.

■ Opción 1: Montaje en Mástil

- 1 Afloje y quite completamente el extremo de la correa de metal girando el tornillo cautivo en sentido antihorario con un destornillador de cabeza plana.

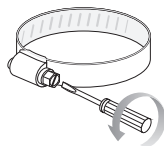

- 2 Lleve el extremo de la correa de metal a la parte posterior del punto de acceso.

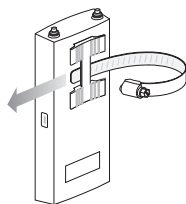

- 3 Coloque el punto de acceso y enrolle la correa metálica alrededor del poste. Introduzca el extremo hacia atrás mediante el bloque de tornillo y gírelo en el sentido de las agujas del reloj para apretar la correa de metal con un destornillador de cabeza plana hasta que el punto de acceso esté fijado.

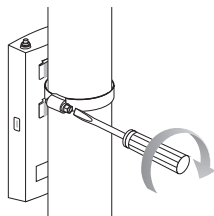

- 4 Conecte las antenas al Punto de Acceso.

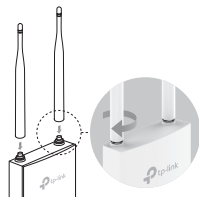

■ Opción 2: Montaje de Pared

- 1 Coloque el brazaletes de montaje en la posición correcta. Marque tres posiciones para los agujeros de los tornillos. Taladre tres agujeros de 6 mm en las posiciones marcadas para los tornillos.

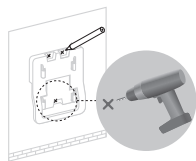

- 2 Inserte los anclajes de pared de plástico en los orificios de 6 mm. Alinee el soporte a los anclajes de pared de plástico y accione los tornillos de autorrosca en los anclajes a través del soporte.

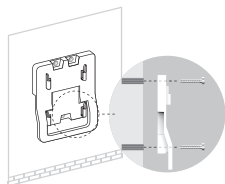

- 3 Alinee las lengüetas de montaje en la parte posterior del punto de acceso con las cuatro ranuras del soporte de montaje. Empuje y deslice el Punto de Acceso hacia abajo hasta que encaje en su lugar.

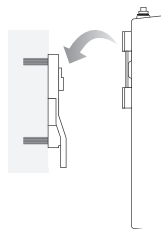

- 4 Conecte las antenas al Punto de Acceso.

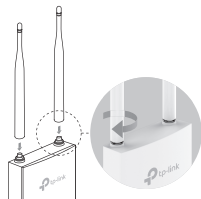

Conexión de Cables

- 1** Sujete firmemente la parte posterior de la cubierta del equipo y tire de ella hacia abajo.
- 2** Utilice un cable Ethernet adecuado para conectar el puerto LAN. Se recomienda el cable blindado CAT5e (o superior) con un cable de tierra integrado.
- 3** Coloque la inserción de goma impermeable en la parte inferior del dispositivo para impermeabilizar y vuelva a colocar la cubierta hasta que encaje firmemente en su lugar.

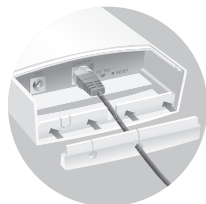

Fuente de Alimentación

■ Alimentación del CAP mediante Switch PoE

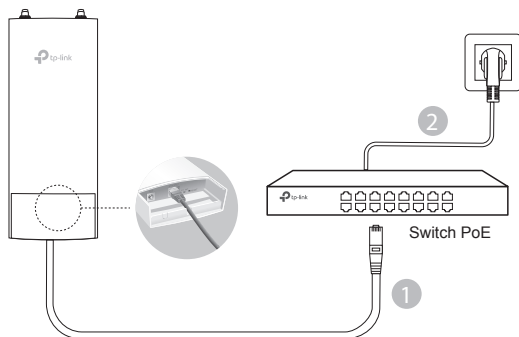

■ Alimentación del EAP mediante Adaptador PoE

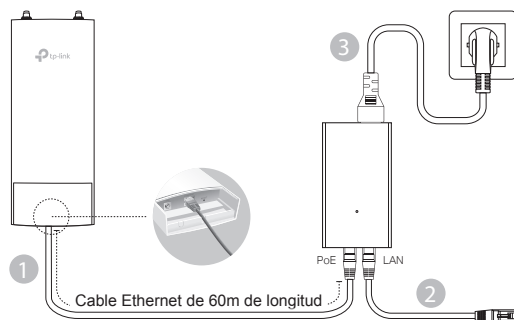

Σημείωση: Οι εικόνες μπορεί να διαφέρουν από το προϊόν.

Συνήθης Τοπολογία Δικτύου

■ Για το EAP

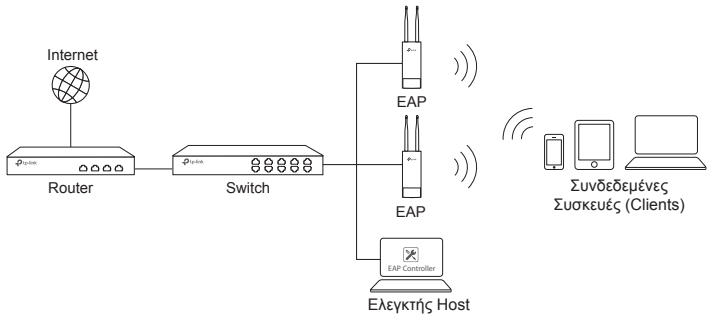

Ένας υπολογιστής που τρέχει το λογισμικό EAP Controller, ο οποίος μπορεί να βρίσκεται στο ίδιο ή σε διαφορετικό υποδίκτυο από τα EAP χρησιμοποιείται για κεντρική διαχείριση των EAP.

Μπορείτε να κατεβάσετε το λογισμικό EAP Controller από την ιστοσελίδα μας <http://www.tp-link.com>.

■ Για το CAP (Κατάσταση FIT)

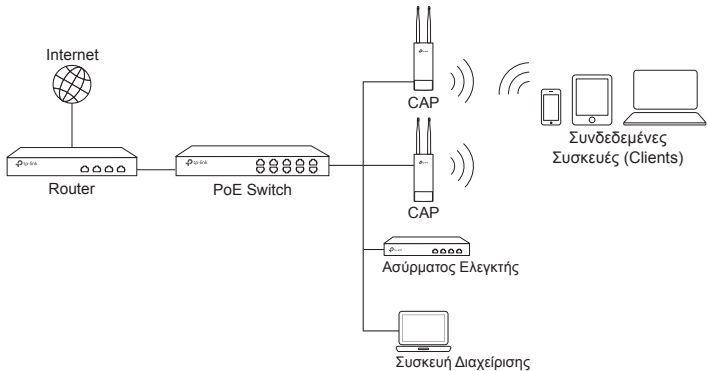

Ένας ασύρματος ελεγκτής μπορεί να βρίσκεται στο ίδιο ή σε διαφορετικό υποδίκτυο από τα CAP και η συσκευή διαχείρισης χρησιμοποιείται για είσοδο στον ασύρματο ελεγκτή ώστε να γίνεται κεντρική διαχείριση των CAP.

Εγκατάσταση Συσκευής

Το Access Point μπορεί να τοποθετηθεί είτε σε ιστό είτε σε τοίχο.

■ Επιλογή 1: Τοποθέτηση σε ιστό

- 1 Χαλαρώστε και αφαιρέστε εντελώς τη μία άκρη του μεταλλικού ιμάντα περιστρέφοντας τη βίδα αριστερόστροφα με ένα ίσιο κατσαβίδι.

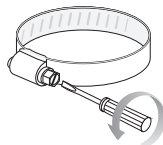

- 2 Περάστε την άκρη του μεταλλικού ιμάντα μέσα από το πίσω μέρος του Access Point.

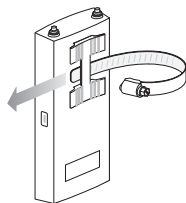

- 3 Τοποθετήστε το Access Point και τυλίξτε το μεταλλικό ιμάντα γύρω από τον ιστό. Περάστε την άκρη ξανά μέσα από τον κύβο με τη βίδα και στρίψτε τη βίδα δεξιόστροφα, χρησιμοποιώντας ένα ίσιο κατσαβίδι, για να σφίξετε τον μεταλλικό ιμάντα μέχρι το Access Point να σταθεροποιηθεί.

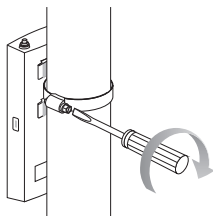

- 4 Συνδέστε τις κεραίες στο Access Point.

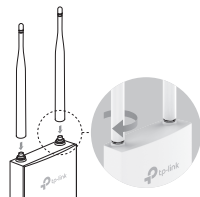

■ Επιλογή 2: Τοποθέτηση σε Τοίχο

- 1 Τοποθετήστε το βραχίονα στήριξης στη σωστή θέση. Σημειώστε τις τρεις θέσεις όπου θα κάνετε τρύπες για τις βίδες. Κάντε τρεις τρύπες 6χιλ. για τις βίδες στα σημεία που σημειώσατε προηγουμένως.

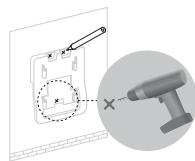

- 2 Τοποθετήστε τα πλαστικά ούπα στις τρύπες 6χιλ. Ευθυγραμμίστε το βραχίονα στήριξης με τα σημεία όπου βάλατε τα ούπα και βιδώστε τις βίδες στα ούπα.

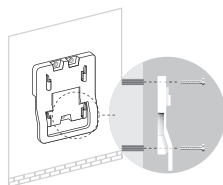

- 3 Ευθυγραμμίστε τις τέσσερις προεξοχές στήριξης που υπάρχουν στο πίσω μέρος του Access Point με τις τέσσερις υποδοχές του βραχίονα στήριξης. Σπρώξτε και σύρετε το Access Point προς τα κάτω ώστε να ασφαλίσει στη θέση του.

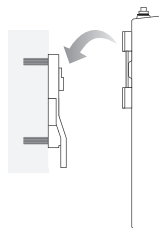

- 4 Συνδέστε τις κεραιές στο Access Point.

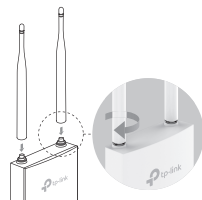

Σύνδεση Καλωδίων

- 1 Πιάστε καλά το πίσω μέρος του καλύμματος υποδοχών και σπρώξτε προς τα κάτω.



- 2 Χρησιμοποιήστε επαρκές καλώδιο Ethernet για να συνδέσετε τη θύρα LAN. Συνιστάται μονωμένο καλώδιο CAT5e (ή παραπάνω) με ενσωματωμένο καλώδιο γείωσης.



- 3 Τοποθετήστε το λάστιχο στεγανοποίησης στο κάτω μέρος της συσκευής ώστε να την κάνετε αδιάβροχη και τοποθετήστε ξανά το κάλυμμα, κουμπώνοντάς το καλά στη θέση του.

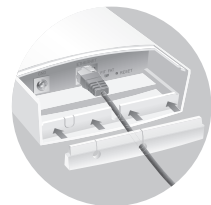

Τροφοδοσία

■ Τροφοδοσία του CAP μέσω PoE Switch

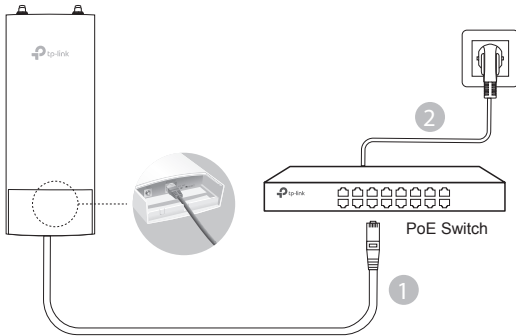

■ Τροφοδοσία του ΕΑΡ μέσω PoE Adapter

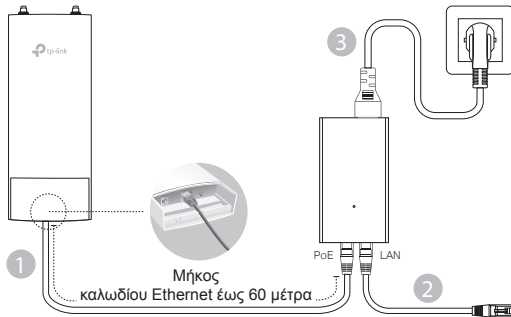

Typologie réseau typique

■ Pour les EAP

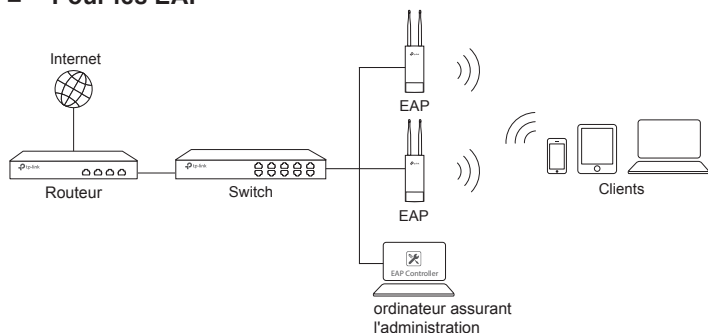

Un ordinateur exécutant le logiciel EAP Controller, pouvant être dans un sous réseau identique ou différent de celui des EAP, est utilisé pour administrer ceux-ci de façon centralisée.

Vous pouvez télécharger le logiciel EAP Controller depuis notre site : <http://www.tp-link.fr>.

■ Pour les CAP (FIT Mode)

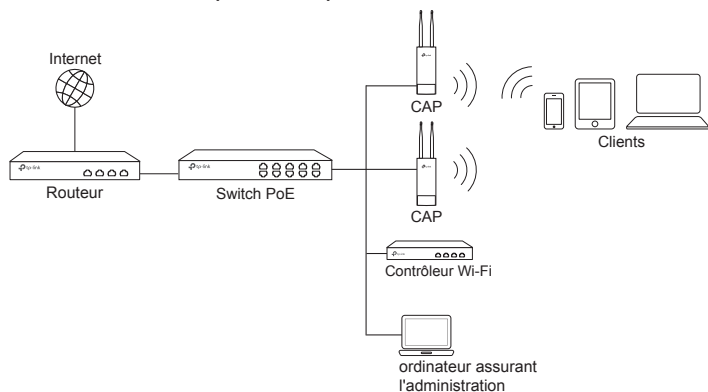

Le contrôleur Wi-Fi peut être dans un sous réseau identique ou différent de celui des CAP. L'ordinateur est utilisé pour se connecter au contrôleur Wi-Fi et administrer ceux-ci de façon centralisée.

Installation matérielle

Le point d'accès peut être fixé sur un mat ou un mur.

■ Option 1 : fixation à un mat

- 1 Desserrer complètement le collier à l'aide d'un tournevis à lame (dans le sens inverse des aiguilles d'une montre) afin de l'ouvrir complètement.

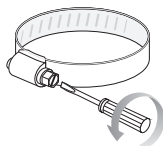

- 2 Passer le collier dans la fente située à l'arrière du point d'accès.

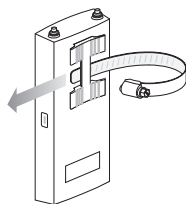

- 3 Positionner le point d'accès et cercler le mat à l'aide du collier. Refermer le collier à l'aide d'un tournevis à lame (dans le sens des aiguilles d'une montre) afin d'enserrer le mat fermement.

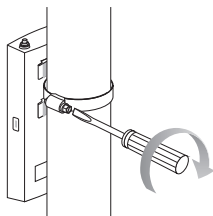

- 4 Connecter les antennes au point d'accès.

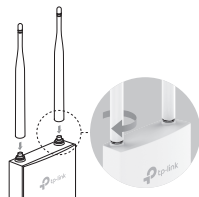

■ Option 2 : Fixation à un mur

- 1 Positionner le support sur le mur et dans le bon sens. Marquer les trois repères de perçage. Percer à l'endroit des repères, à l'aide d'un foret de 6 mm.

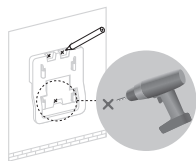

- 2 Insérer les chevilles plastiques dans les trous. Positionner le support sur le mur et insérer les vis dans les trous de celui-ci avant de les ancrer dans les chevilles.

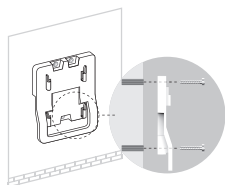

- 3 Aligner les ergots situés à l'arrière du point d'accès avec les quatre encoches du support de montage. Faire glisser le point d'accès vers le bas jusqu'à son verrouillage sur le support de montage.

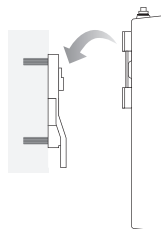

- 4 Connecter les antennes au point d'accès.

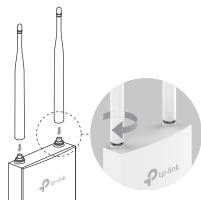

Connecter les câbles

- 1 Tenir fermement le capot et le faire glisser vers le bas.



- 2 Utiliser un cordon Ethernet adapté pour relier le port réseau. Cordon Ethernet de catégorie 5e (ou plus) incorporant un fil de masse (recommandé).



- 3 Positionner la bande d'étanchéité sur la face intérieure de l'appareil pour le rendre étanche puis replacer le couvercle jusqu'à ce qu'il soit verrouillé.

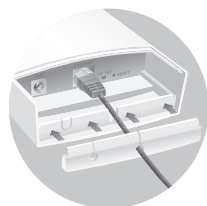

Alimentation

■ Alimenter le CAP à l'aide d'un switch PoE

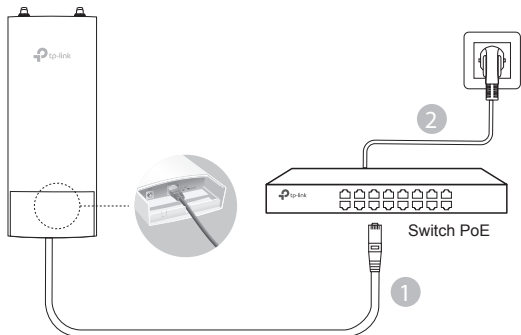

■ Alimenter l'EAP à l'aide de son injecteur PoE

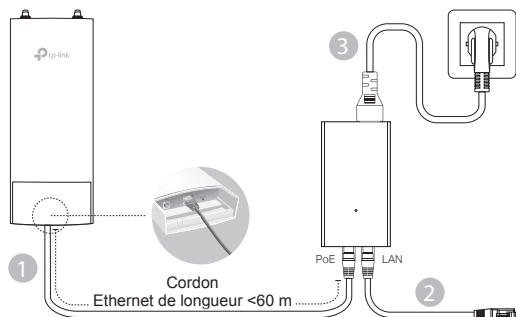

Nota: L'immagine può essere diversa dal prodotto attuale.

Topologia di Rete Tipica

■ Per EAP

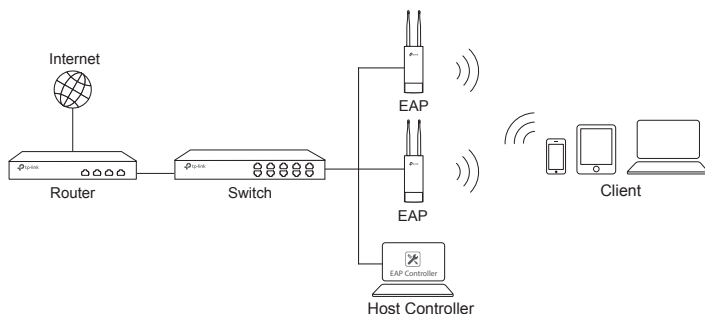

Un computer con il software EAP Controller, che può essere presente nella stessa o in un'altra subnet degli EAP, viene utilizzato per gestire centralmente gli EAP.

Potete ottenere il software EAP Controller dal sito web <http://www.tp-link.it>.

■ Per CAP (FIT Mode)

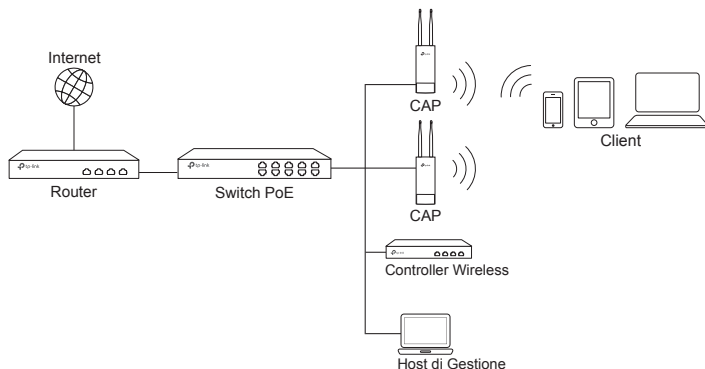

Il controller wireless può essere presente nella stessa o in un'altra subnet dei CAP. L'host di gestione viene usato per fare login al controller wireless per gestire centralmente i CAP.

Installazione Hardware

L'Access Point può essere montato su palo o a muro.

■ Opzione 1: Montaggio su Palo

- 1 Allentate e rimuovete completamente l'estremità della cinghia metallica svitando in senso antiorario la vite di blocco con un cacciavite a taglio.

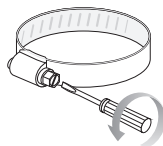

- 2 Infilate l'estremità della cinghia metallica nella fessura presente nella parte posteriore dell'Access Point.

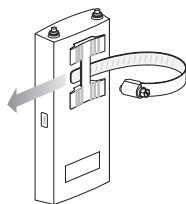

- 3 Posizionate l'Access Point e avvolgete la striscia metallica attorno al palo. Infilate l'estremità nella vite di bloccaggio, e avvitate la vite in senso orario per stringere la striscia metallica usando un cacciavite a taglio fino a quando l'Access Point è assicurato saldamente al palo.

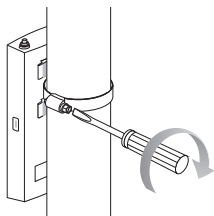

- 4 Collegate le antenne all'Access Point.

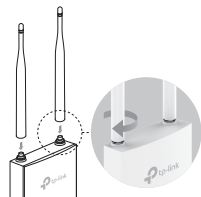

■ Opzione 2: Montaggio a Muro

- 1** Posizionate la staffa di montaggio nella posizione desiderata. Segnate le 3 posizioni per i fori delle viti. Trapanate 3 fori per le viti da 6 mm in corrispondenza delle posizioni precedentemente indicate.

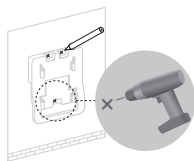

- 2** Inserite i fisher di plastica nei fori da 6 mm. Allineate la staffa ai fori e posizionate le viti nei fisher di plastica ancorando la staffa al muro.

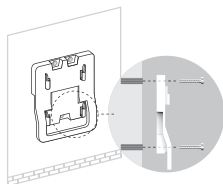

- 3** Allineate le linguette di montaggio della parte posteriore dell'Access Point con le 4 tacche della staffa di montaggio. Montate l'Access Point sulla staffa fino a quando non si posiziona correttamente.

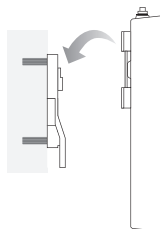

- 4** Collegate le antenne all'Access Point.

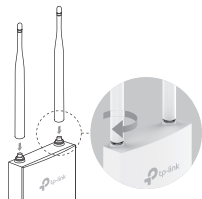

Connessione Cavi

- 1** Afferrate saldamente la parte posteriore della placca che protegge le interfacce e tiratela verso il basso.



- 2** Connettete un cavo Ethernet alla porta LAN. Si consiglia un cavo schermato CAT5e (o superiore) con messa a terra integrata.



- 3** Applicate la protezione di gomma waterproof nella parte inferiore del dispositivo per impermeabilizzarlo e riposizionate la placca di protezione fino a che si blocca saldamente nella posizione corretta.

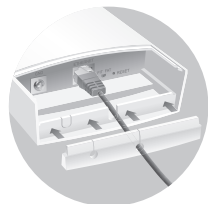

Alimentazione

■ Alimentate il CAP mediante uno switch PoE

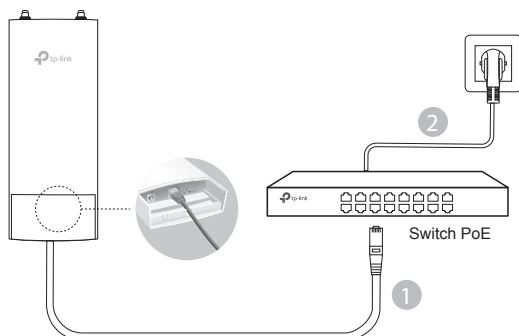

■ Alimentate lo EAP mediante un adattatore PoE

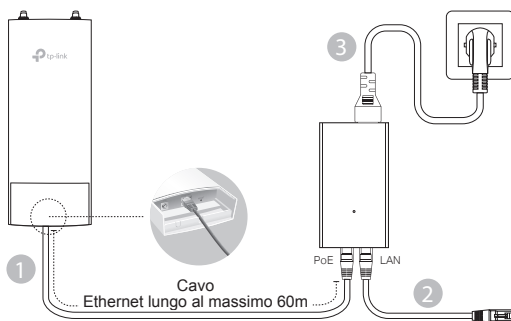

Nota: A imagem pode ser diferente do produto atual.

Topologia Típica de Rede

■ Para o EAP

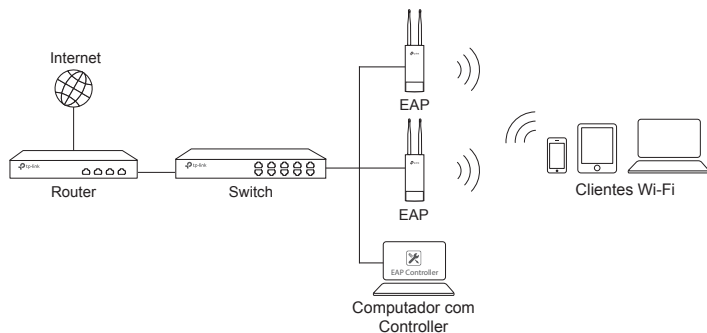

Poderá gerir centralmente os EAPs através do software EAP Controller, que pode estar instalado num computador na mesma rede ou numa sub-rede diferente.

Poderá obter o software EAP Controller no nosso Website em www.tp-link.pt.

■ Para o CAP (Modo FIT)

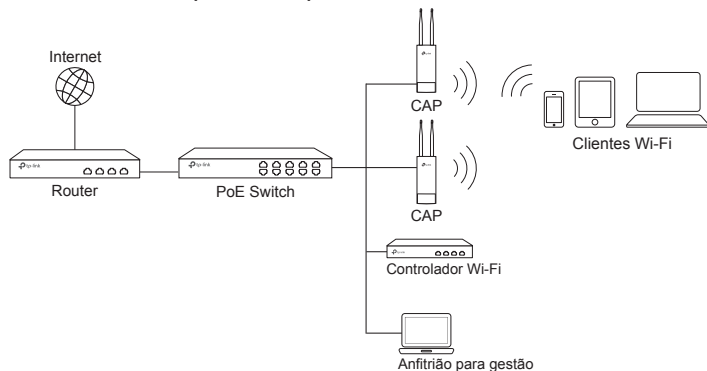

O controlador Wi-Fi pode estar na mesma rede ou em sub-redes diferentes dos dispositivos CAP. O anfitrião de gestão é utilizado para iniciar a sessão no controlador Wi-Fi para gerir centralmente os CAPs.

Instalação do equipamento

O Ponto de Acesso pode ser instalado num poste ou numa parede.

■ Opção 1: Montagem num poste

- 1 Solte e remova completamente a extremidade da braçadeira metálica girando o parafuso no sentido anti-horário com uma chave de fendas.

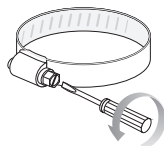

- 2 Conduza a extremidade da alça da braçadeira metálica pela parte de trás do Ponto de Acesso.

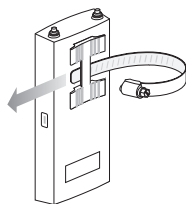

- 3 Posicione o Ponto de Acesso e enrole a alça da braçadeira metálica ao redor do poste. Aperte a braçadeira metálica através do parafuso ao girar o mesmo no sentido dos ponteiros do relógio com uma chave de fendas até que o Ponto de Acesso fique seguro.

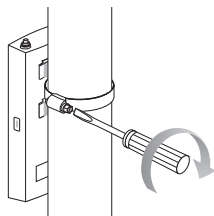

- 4 Conecte as antenas ao Ponto de Acesso.

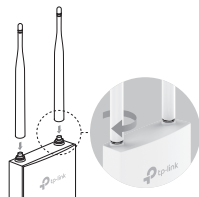

■ Opção 2: Montagem numa parede

- 1** Coloque o suporte de montagem na posição correta. Marque três posições para os orifícios dos parafusos. Faça três furos de 6 mm de diâmetro para os parafusos nas posições marcadas.

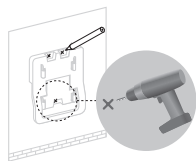

- 2** Inserir as buchas de plástico nos furos de 6 mm. Alinhe o suporte às buchas de plástico e aperte os parafusos nas buchas através do suporte.

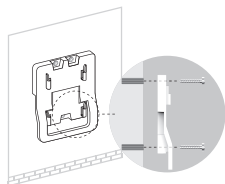

- 3** Alinhe as guias de montagem na parte de trás do Ponto de Acesso com os quatro furos do suporte de montagem. Empurre e deslize o Ponto de Acesso para baixo até que encaixe no lugar.

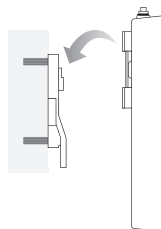

- 4** Ligue as antenas ao Ponto de Acesso.

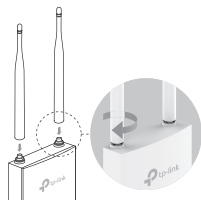

Ligação dos Cabos

- 1 Segure firmemente a parte traseira da tampa da antena e puxe-a para baixo.



- 2 Use um cabo Ethernet adequado para ligar à porta LAN. É recomendado a utilização de um cabo blindado CAT5e (ou superior) com um fio de terra integrado..



- 3 Coloque a membrana de borracha impermeável na parte inferior do dispositivo para que possa impermeabilizar o dispositivo.

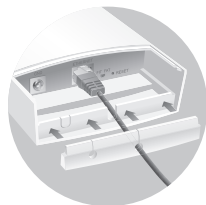

Fonte de alimentação

■ Alimentação da antena CAP via Switch com PoE

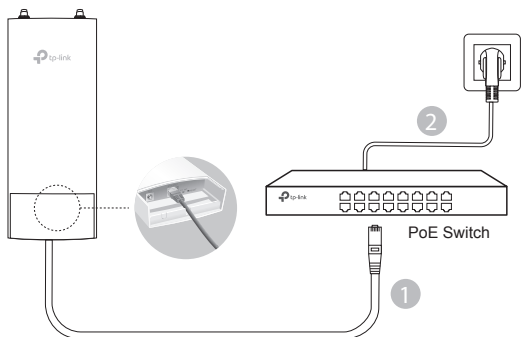

■ Alimentação da antena EAP via Adaptador com PoE

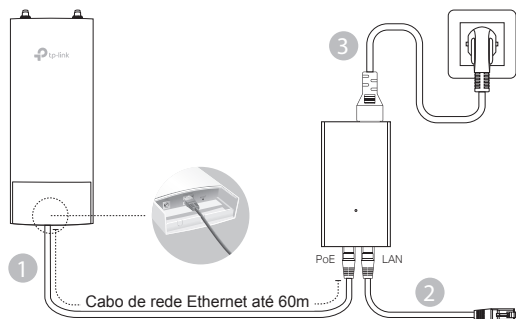

Huomautus: Kuva saattaa poiketa varsinaisesta tuotteesta.

Tyypillinen verkkotopologia

■ EAP

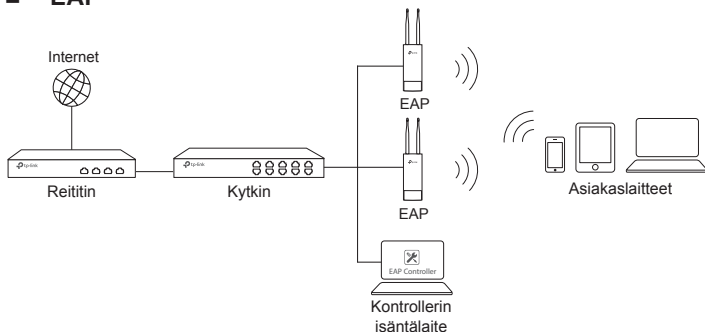

EAP:itä hallinnoidaan keskitetysti tietokoneella jossa on EAP Controller -ohjelmisto ja joka voi olla samassa tai eri aliverkossa kuin EAP.

EAP Controller -ohjelmisto voidaan ladata sivustoltamme <http://www.tp-link.com>.

■ CAP (FIT-tila)

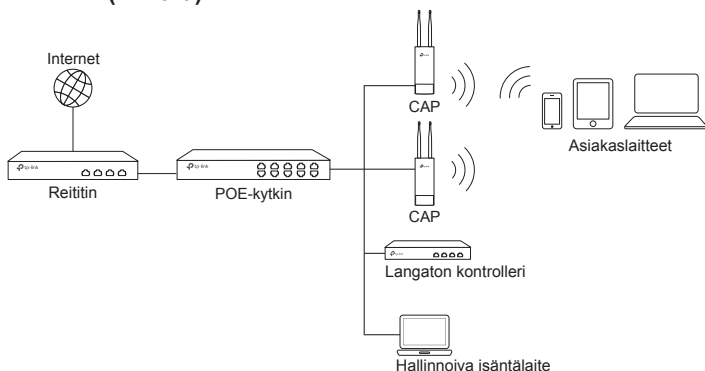

Langaton kontrolleri voi olla samassa tai eri aliverkossa CAP:ien kanssa.

Hallinnoiva isäntälaitte kirjautuu langattomaan kontrolleriin hallinnoidakseen CAP:ejä keskitetysti.

Laitteiston asennus

Tukiasema voi olla asennettu paaluun tai seinälle.

■ Vaihtoehto 1: Asennus paaluun

- 1 Löysennä ja irrota metallihinnan pää kiertämällä kiinnitysruuvia vastapäivään ruuvitaltalla.

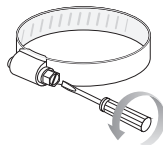

- 2 Vedä metallihinnan pää tukiaseman takaosan läpi.

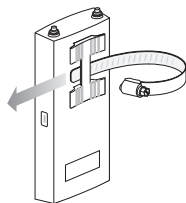

- 3 Aseta tukiasema paikoilleen ja kiedo metallihinna tangon ympärille. Työnnä hinhan pää ruuviväkivivun läpi ja kiristä metallihinna kiertämällä ruuvia myötäpäivään ruuvitaltalla, kunnes tukiasema istuu tiukasti paikoillaan.

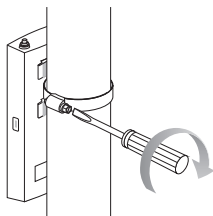

- 4 Kytke antennit tukiasemaan.

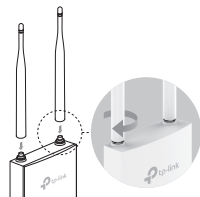

■ Vaihtoehto 2: Asennus seinälle

- 1 Laita asennuskiinnike oikeaan asentoon. Merkitse kolmen ruuvinreiän paikat. Poraa kolme 6 mm:n ruuvinreikää merkittyihin kohtiin.

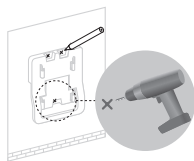

- 2 Työnnä muoviset seinäkiinnikkeet 6 mm:n reikiin. Kohdista kiinnike muovisten seinäkiinnikkeiden kanssa ja ruuvaa itsekierteytyvät ruuvit seinäkiinnikkeisiin kiinnikkeen läpi.

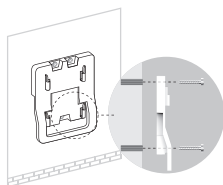

- 3 Kohdista tukiaseman takana olevat asennuskiekket asennuskiinnikkeen neljän loven kanssa. Työnnä tukiasemaa alaspäin, kunnes se lukittuu paikoilleen.

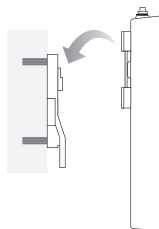

- 4 Kytke antennit tukiasemaan.

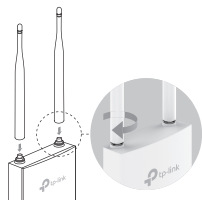

Kytke kaapelit

- 1** Ota tiukasti kiinni liittimen kuoren takaosasta ja vedä sitä alaspäin.



- 2** Kytke LAN-portti riittävän pitkällä Ethernet-kaapelilla. Suosittelemme suojattua CAT5e (tai korkeampaa) -kaapelia, jossa on kiinteä maadoitusjohto.



- 3** Kiinnitä vesitiivis kumisisäke laitteen alle tiivistääksesi sen vedeltä ja asenna kansi siten, että se lukittuu tukevasti paikoilleen.

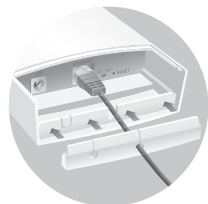

Virtalähde

■ Kytke virta CAP:iin PoE-kytkimen kautta

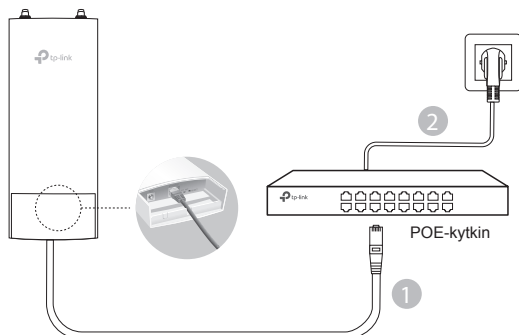

■ Kytke virta EAP:iin PoE-sovittimen kautta

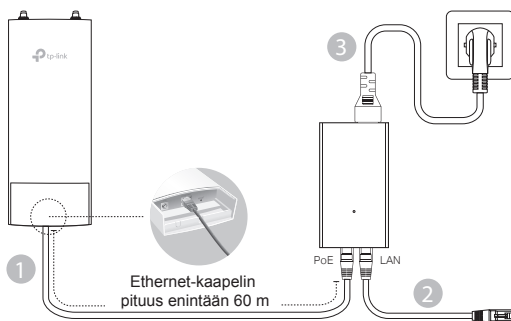

Opmerking: De afbeelding kan afwijkend zijn van het daadwerkelijke product.

Typische Network Topologie

■ Voor de EAP

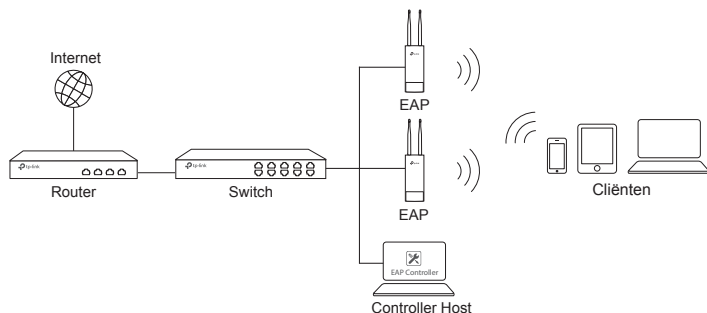

Een computer waar de EAP controller software op draait, kan zich in dezelfde of in andere subnets als de EAP bevinden en wordt gebruikt om de EAP's centraal te beheren.

U kunt de EAP Controller software verkrijgen op onze website <http://www.tp-link.com>.

■ Voor de CAP (FIT Modus)

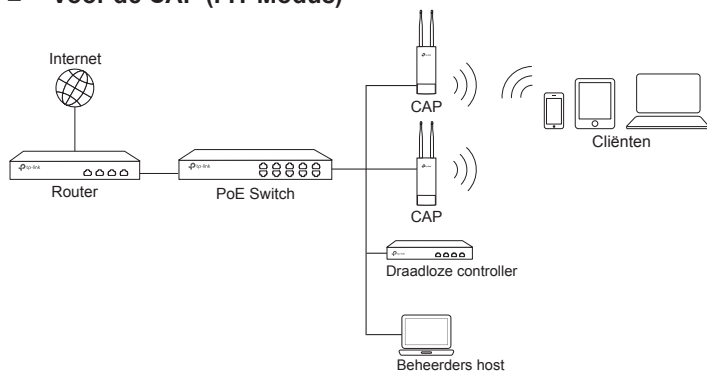

De draadloze controller kan zich in dezelfde of in verschillende subnets als de CAP's bevinden. De beheerders host wordt gebruikt om in te loggen op de draadloze controller om de CAP's centraal te beheren.

Hardware installatie

Het access point kan aan een paal of aan een muur worden bevestigd.

■ Optie 1: Paal montage

- 1 Verwijder het eind van de metalen band volledig los en schroef deze los door de schroef met een platte schroevendraaier tegen de klok in te draaien.

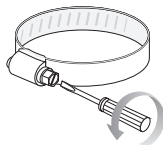

- 2 Geleid het einde van de metalen band door de achterkant van het access point.

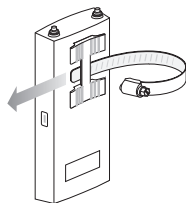

- 3 Positioneer het access point en draai de metalen band om de paal heen. Geleid het einde terug door het schroef blok en draai de schroef met de klok mee door gebruik te maken van een platte schroevendraaier om de metalen band vast te maken zodat het access point veilig is bevestigd.

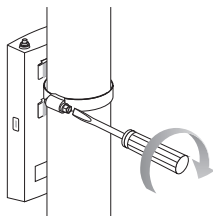

- 4 Verbind de antenne's met het access point.

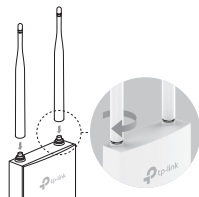

■ Optie 2: Muur bevestiging

- 1 Plaats de montagbeugels in de goede positie. Markeer 3 posities voor de schroefgaten. Boor 3 x 6 mm gaten voor de schroeven op de gemarkeerde posities.

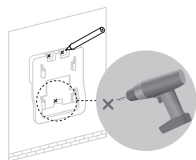

- 2 Plaats de plastic pluggen in de 6 mm gaten. Richt de beugel op de plastic muurankers en draai de zelftappende schroeven in de ankers door de beugel.

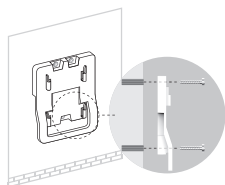

- 3 Plaats de montage tabs op de achterkant van het access point over de 4 sloten van de montage beugel. Druk en geleid het access point naar beneden totdat deze op zijn plaats in het slot valt.

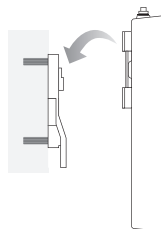

- 4 Verbind de antenne's met het access point.

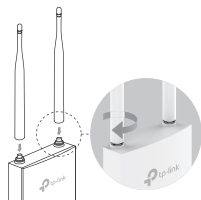

Verbind de kabels

- 1 Pak de achterkant van het achterklepje stevig vast en trek dit naar beneden.



- 2 Gebruik een geschikte Ethernet kabel om te verbinden met de LAN poort. Afgeschermde CAT5e kabels (of daarboven) met een geïntegreerde aarddraad is aanbevolen.



- 3 Bevestig de waterdichte rubbers aan de onderkant van het apparaat voor waterdichtheid en herplaats de cover totdat deze goed op zijn plaats valt.

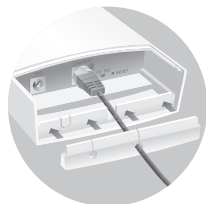

Voedingsadapter

■ Voorzie de CAP van stroom via de PoE switch

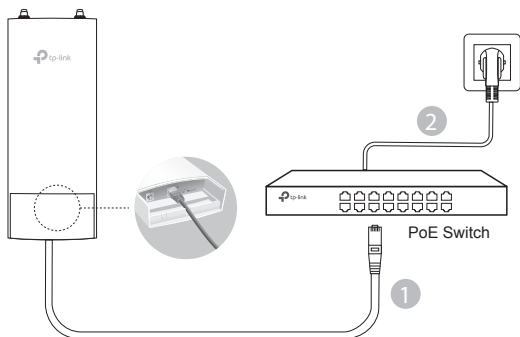

■ Voorzie de EAP van stroom via de PoE adapter

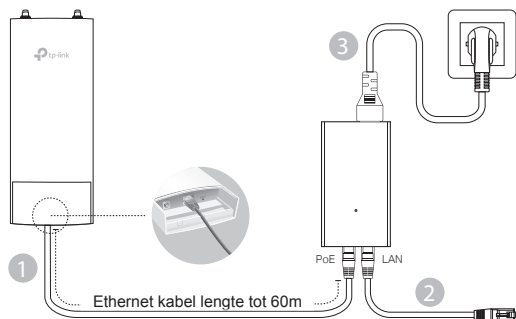

Obs! Bilden kan skilja sig från den faktiska produkten.

Typisk nätverkstopologi

■ För EAP

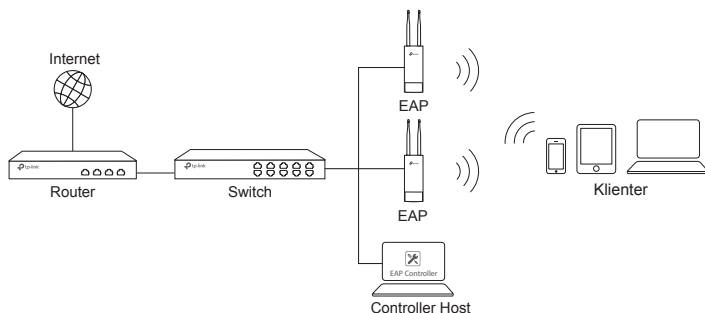

En dator som kör EAP-styrenhet, kan vara i samma eller olika subnät med EAP:er, och används för att centralt hantera EAP:er.

Du kan få EAP Controller från vår hemsida <http://www.tp-link.com>.

■ För CAP (FIT-funktion)

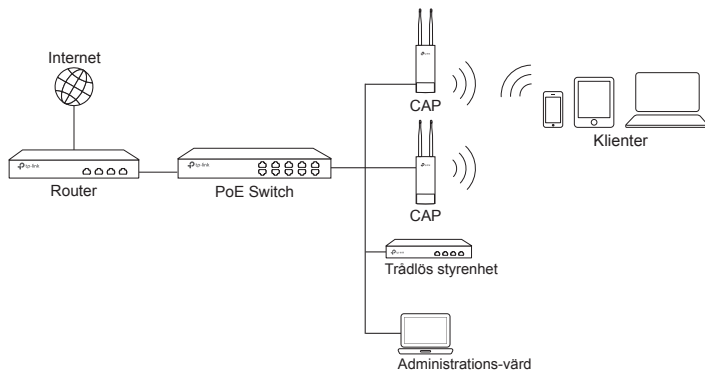

Den trådlösa styrenheten kan vara i samma eller olika subnät som CAP.

Administrations-värden används för att logga in på styrenheten för att centralt hantera CAP.

Installation av maskinvara

Accesspunkten kan vara stolpmonterad eller väggmonterad.

■ Alternativ 1: Stolpmontering

- 1 Lossa och ta helt bort änden av metallbandet genom att vrida skruven moturs med en skruvmejsel.

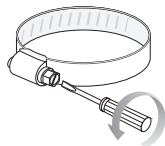

- 2 Led änden av metallbandet genom baksidan av Access Point.

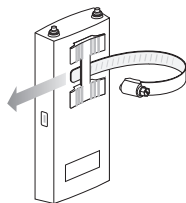

- 3 Placera accesspunkten och metallbandet lindat runt stängan. Mata slutet tillbaka genom skruvblocket och vrid skruven medurs för att dra åt metallbandet med hjälp av en skruvmejsel tills åtkomspunkten sitter säkert.

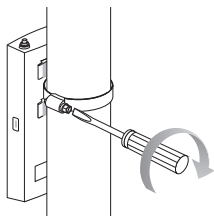

- 4 Anslut antennerna till åtkomspunkten.

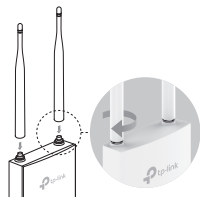

■ Alternativ 2: Vägghäring

- 1 Placera monteringsfästet i rätt position. Markera de tre lägena för skruvhålen. Borra tre 6 mm hål för skruvarna på de markerade positionerna.

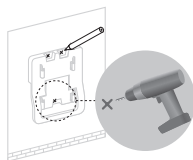

- 2 Sätt in väggankare av plast i 6 mm hålen. Rikta konsolen till väggankare och skruva i de självborrande skruvarna genom fästet.

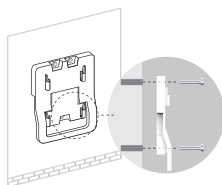

- 3 Rikta in monteringsstapparna på baksidan av Access Point med de fyra hålen på fästet. Tryck och skjut åtkomstpunkten nedåt tills den låses på plats.

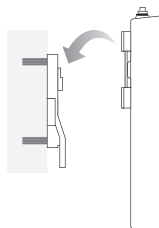

- 4 Anslut antennerna till åtkomstpunkten.

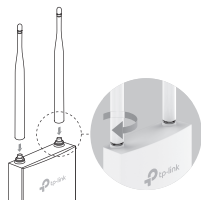

Anslut kablar

- 1 Tag kraftigt tag i baksidan av gränssnittsluckan och dra nedåt.



- 2 Använd en lämplig Ethernet-kabel för att ansluta LAN-porten. Skärmad KAT5e (eller högre) kabel med en integrerad jordledning rekommenderas.



- 3 Fäst vattentäta gummiinsatsen på undersidan av enheten och sätt tillbaka locket tills den sitter på plats.

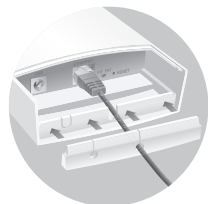

Strömförsörjning

■ Anslut el till CAP via PoE-switch

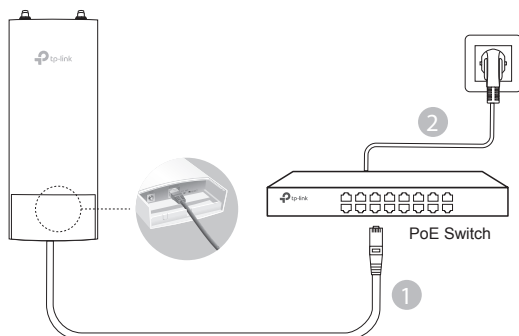

■ Anslut el till EAP via PoE-enheten

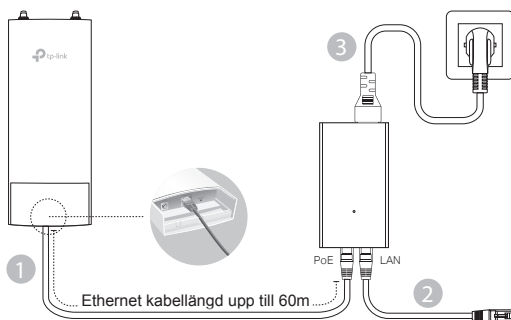

Merk: Bildet kan avvike fra det faktiske produktet.

Typisk nettverksstruktur

■ For EAP

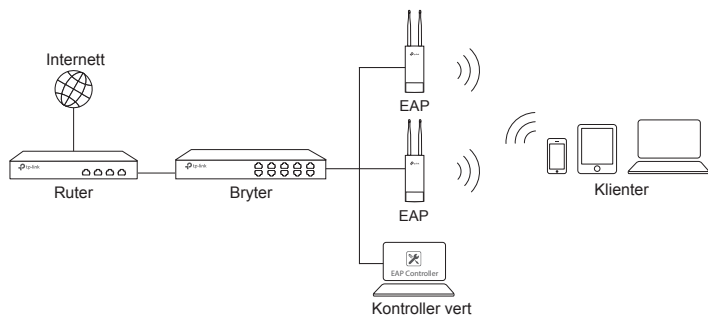

En datamaskin som bruker EAP Controller-programvaren, i samme eller forskjellig undernett som EAP-er, brukes til å administrere EAP-er.

Du kan laste ned EAP Controller-programvaren fra vår nettside, <http://www.tp-link.com>.

■ For CAP (FIT-modus)

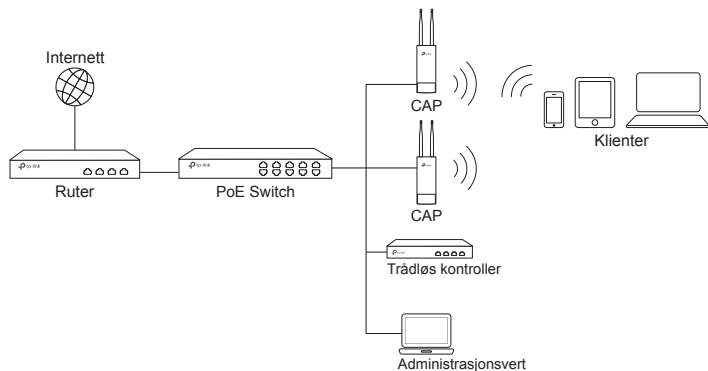

Den trådløse kontrolløren kan være i det samme eller et forskjellig undernett som CAP-er. Og administrasjonsverten brukes til å logge inn på den trådløse kontrolløren for å sentraladministrere CAP-er.

Installasjon av maskinvare

Aksesspunktet kan monteres på en stolpe eller en vegg.

■ Alternativ 1: Montering på stolpe

- 1 Løsne og ta helt ut enden av metallbåndet ved å skru festeskruen mot klokken med en flathodet skrutrekker.

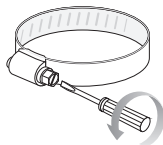

- 2 Tre enden av metallbåndet gjennom baksiden av aksesspunktet.

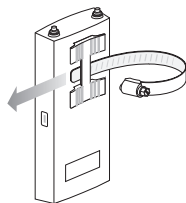

- 3 Posisjoner aksesspunktet og trekk metallbåndet rundt stolpen. Før enden tilbake gjennom festet og skru skruen med klokken, med en flathodet skrutrekker, inntil aksesspunktet sitter fast.

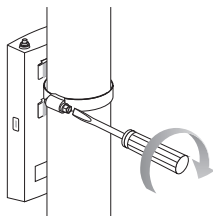

- 4 Fest antennene til aksesspunktet.

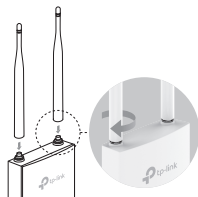

■ Alternativ 2: Montering på vegg

- 1 Plasser monteringsbraketten i ønsket posisjon. Marker tre posisjoner for skru hullene. Bor tre hull på 6 mm for skruene i de markerte posisjonene.

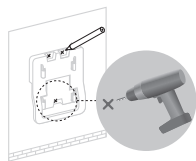

- 2 Sett veggpluggene av plast inn i de 6 mm store hullene. Juster plasseringen til braketten etter veggpluggene og skru de selvborende skruene inn i pluggene gjennom braketten.

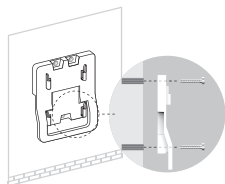

- 3 Tilpass monteringsstappene på baksiden av aksesspunktet etter de fire sporene i monteringsbraketten. Trykk inn og skyv aksesspunktet nedover inntil det låses på plass.

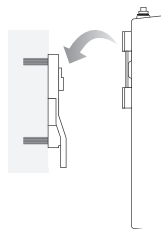

- 4 Fest antennene til aksesspunktet.

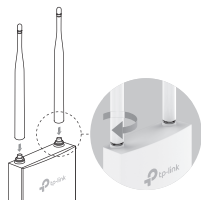

Koble til kabler

- 1 Hold godt tak i bakparten av brukerpanel-dekselet og dra det nedover.



- 2 Bruk en passende nettverkskabel for å koble til LAN-porten. Skjermet CAT5e (eller høyere) kabel med integrert jordleder er anbefalt.



- 3 Fest den vanntette gummlisten til undersiden av enheten for å beskytte mot fukt, og sett tilbake dekselet inntil det låses på plass.

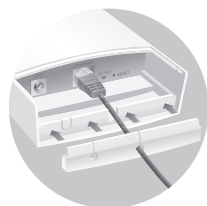

Strømforsyning

■ Strøm til CAP via PoE switch

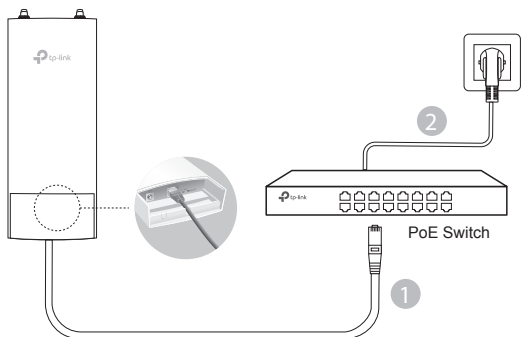

■ Strøm til EAP via PoE adapter

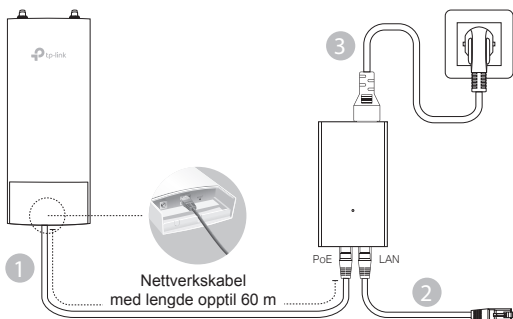

Bemærk: Billedet kan afvige fra det faktiske produkt.

Typisk netværkstopologi

■ For EAP'en

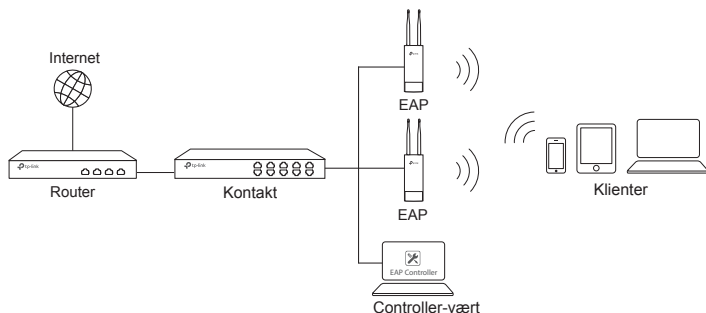

En computer, der kører EAP-controller-software, der kan være i det samme eller et andet undernet som EAP'erne, bruges til at styre EAP'erne centralt.

Du kan hente EAP-softwaren fra vores hjemmeside <http://www.tp-link.com>.

■ For CAP'en (FIT-tilstand)

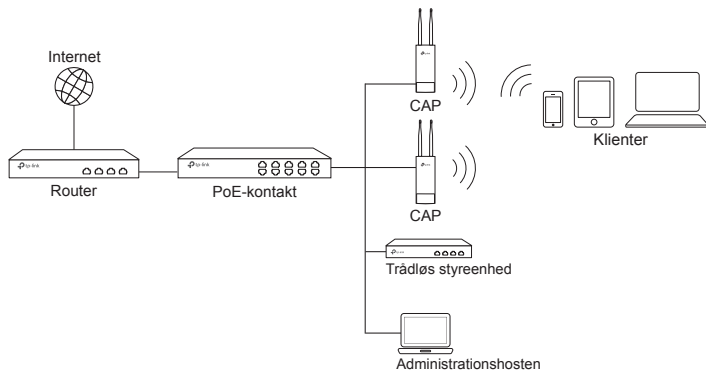

Den trådløse styreenhed kan være på samme eller et andet undernet med CAP'er. Og administrationsshosten bruges til at logge ind på den trådløse styreenhed for at styre CAP'erne.

Hardwareinstallation

Adgangspunktet kan være polmonteret eller kan monteres på væggen.

■ Mulighed 1: Polmonteret

- 1 Løsn og fjern enden af metalbåndet helt ved at dreje skruen mod uret med en almindelig skruetrækker.

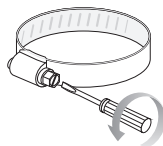

- 2 Led enden af metalbåndet gennem bagsiden af adgangspunktet.

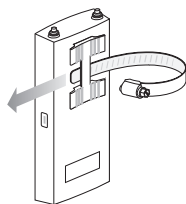

- 3 Anbring adgangspunktet og vikl metalbåndet rundt om stangen. Før enden tilbage gennem skrue-blokken og drej skruen med uret for at stramme metalbåndet ved hjælp af en almindelig skruetrækker indtil adgangspunktet er sikkert fastgjort.

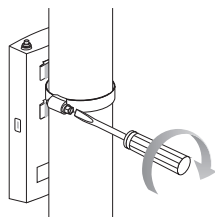

- 4 Tilslut antennerne til adgangspunktet.

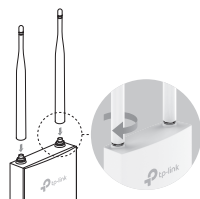

■ Mulighed 2: Montering på væg

- 1 Placer monteringsbeslaget i den rigtige position. Marker tre positioner for skruenhullerne. Bor tre 6 mm huller til skrueerne på de markerede positioner.

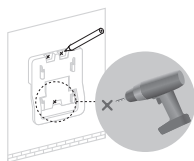

- 2 Indsæt plastik murankre i 6 mm hullerne. Juster beslaget til plastik murankrene og skru de selvskærende skruer ind i ankrene gennem beslaget.

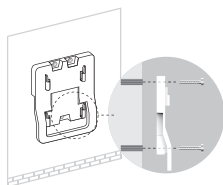

- 3 Tilpas monteringsbeslagene på bagsiden af adgangspunktet med de fire riller på monteringsbeslaget. Skub og flyt adgangspunktet nedad, indtil den låses på plads.

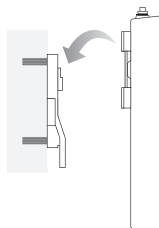

- 4 Tilslut antennerne til adgangspunktet.

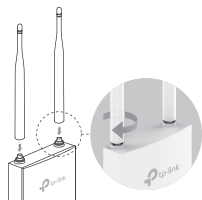

Tilslut kabler

- 1 Hold godt fast i den bagerste del af brugerfladen og træk den nedad.



- 2 Brug et passende Ethernet-kabel til at tilslutte LAN-porten. Skærmet CAT5e (eller over) kabel med en integreret jordledning anbefales.



- 3 Fastsæt det vandtæt gummiindsæt til undersiden af enheden for at gøre det vandtæt og udskifte dækslet, indtil det låses på plads.

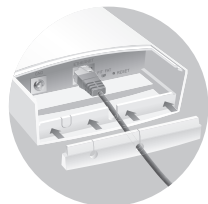

Strømforsyning

■ Tænd CAP'en via PoE-switch

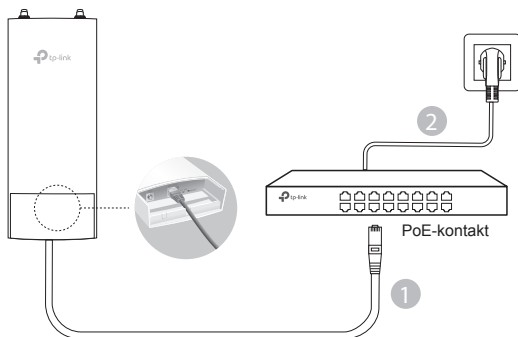

■ Tænd EAP'en via PoE-adapteren

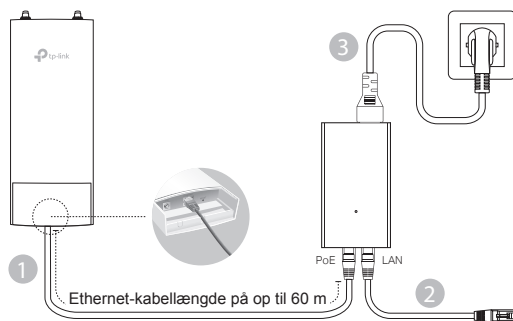

Deutsch

Sicherheitsinformation

- Hat ein Produkt eine POWER-Taste, kann das Gerät damit komplett abgeschaltet werden. Produkte ohne POWER-Taste können einzig und allein durch Trennen des Spannungsadapters komplett ausgeschaltet werden. Das von der Spannungsversorgung getrennte Gerät behält jedoch seine Konfiguration.
- Öffnen Sie dieses Produkt nicht und versuchen Sie nicht, es zu warten oder zu reparieren. Sie könnten Spannungsschlägen oder anderen Gefahren ausgesetzt sein. Das Entfernen oder Beschädigen eines Siegels lässt die Garantie erlöschen. Bitte wenden Sie sich an uns, wenn Ihr Gerät defekt ist.
- Betreiben Sie dieses Produkt nicht in der Nähe von Wasser.

Eingeschränkte Produktgarantie von TP-Link

Nur für Original-TP-Link-Produkte.

DIESE GARANTIE VERLEIHT IHNEN BESTIMMTE RECHTE, DIE VON DEM VERKAUFSLAND ABHÄNGIG SEIN KÖNNEN. BIS ZU DEN GESETZLICHEN GRENZEN ERSETZEN DIESE GARANTIE UND DIESE HILFESTELLUNGEN ANDERSARTIGE GARANTIE, HILFESTELLUNGEN UND KONDITIONEN.

TP-Link garantiert für einen einwandfreien Zustand von originalverpackten TP-Link-Geräten hinsichtlich Funktion und Materialverarbeitung, normale Benutzung vorausgesetzt.

English

Safety Information

- When a product has a power on/off button, the power on/off button is one way to turn-off the product. For products without the on/off button, the only way to completely turn-off the product is to disconnect the product or the power adapter from the power source. The disconnected device shall remain readily operable.
- Do not open this product or attempt to service it; it may expose you to dangerous high voltage or other risks. Opening a sealed component or sealed product/s will void the warranty. For product servicing, please contact us.
- Do not operate this product near water.

TP-Link Limited Product Warranty

For TP-Link Branded Products Only.

THIS WARRANTY GIVES YOU SPECIFIC LEGAL RIGHTS, AND YOU MAY HAVE OTHER RIGHTS THAT VARY FROM STATE TO STATE (OR BY COUNTRY OR PROVINCE).

TO THE EXTENT ALLOWED BY LOCAL LAW, THIS WARRANTY AND THE REMEDIES SET FORTH ARE EXCLUSIVE AND IN LIEU OF ALL OTHER WARRANTIES, REMEDIES AND CONDITIONS.

TP-Link warrants the TP-Link branded hardware product contained in the original packaging against defects in materials and workmanship when used normally in according with TP-Link's guidelines for some period which depends on the local service from the date of original retail purchase by the end-user purchaser.

Español

Información de seguridad

- Cuando un producto dispone de un interruptor de encendido y apagado, este botón constituye uno de los métodos para apagar el producto. Para aquellos productos que carecen de un botón de apagado y encendido, el único método de apagarlos consiste en desconectar el producto o el adaptador de corriente del enchufe de alimentación. El dispositivo deberá permanecer operativo en todo momento.
- No abra o intente reparar el producto, ya que puede quedar expuesto a un peligro por alto voltaje u otro tipo de riesgos. La apertura de un componente o producto sellado invalidará la garantía. Si necesita reparar el producto, por favor, póngase en contacto con nosotros.
- No utilice este producto cerca del agua.

Garantía limitada para productos de TP-Link

Sólo para productos que porten la marca TP-Link.

ESTA GARANTÍA LE CONFIERE DERECHOS LEGALES ESPECÍFICOS, Y ES POSIBLE QUE USTED DISPONGA DE OTROS DERECHOS, LOS CUALES PUEDEN VARIAR SEGÚN EL ESTADO (O SEGÚN EL PAÍS O PROVINCIA).

EN LA MEDIDA QUE LO PERMITA LA JURISDICCIÓN LOCAL, ESTA GARANTÍA Y LOS RECURSOS ESTABLECIDOS EN ELLA SON EXCLUSIVOS EN LUGAR DE CUALQUIER OTRA GARANTÍA, RECURSO Y CONDICIÓN.

TP-Link garantiza el producto de hardware que porta la marca TP-Link contenido en la caja original contra defectos en los materiales y mano de obra bajo condiciones normales de uso de acuerdo con las directrices de TP-Link por un periodo que depende del servicio local desde la fecha original de compra en la tienda por parte del usuario final adquirente.

Ελληνικά

Πληροφορίες ασφάλειας

- Αν κάποια συσκευή διαθέτει πλήκτρο τροφοδοσίας (on/off), αυτό το πλήκτρο είναι ένας από τους τρόπους απενεργοποίησης της συσκευής. Αν η συσκευή δεν διαθέτει πλήκτρο τροφοδοσίας (on/off), ο μοναδικός τρόπος πλήρους απενεργοποίησης είναι η αποσύνδεση της συσκευής ή του τροφοδοτικού από την πρίζα. Η αποσυνδεδεμένη συσκευή μπορεί να συνδεθεί και να χρησιμοποιηθεί ξανά μελλοντικά.
- Μην ανοίξετε τη συσκευή και μην επιχειρήσετε να την επισκευάσετε. Μπορεί να εκτεθείτε σε επικίνδυνη τάση ή άλλους κινδύνους. Αν ανοίξετε κάποιο σφραγισμένο εξάρτημα ή συσκευή(ές), θα ακυρώσετε την εγγύηση. Για επισκευές, παρακαλούμε να επικοινωνήσετε με την εταιρεία μας.
- Μην χρησιμοποιήσετε τη συσκευή κοντά σε νερό.

Περιορισμένη Εγγύηση TP-Link

Μόνο για προϊόντα TP-Link.

ΑΥΤΗ Η ΕΓΓΥΗΣΗ ΣΑΣ ΔΙΝΕΙ ΣΥΓΚΡΕΚΡΙΜΕΝΑ ΝΟΜΙΚΑ ΔΙΚΑΙΩΜΑΤΑ, ΑΛΛΑ ΜΠΟΡΕΙ ΝΑ ΕΧΕΤΕ ΚΑΙ ΑΛΛΑ ΔΙΚΑΙΩΜΑΤΑ, ΑΝΑΛΟΓΑ ΜΕ ΤΗ ΝΟΜΟΘΕΣΙΑ ΤΟΥ ΤΟΠΟΥ ΚΑΤΟΙΚΙΑΣ ΣΑΣ (ΚΡΑΤΟΥΣ Ή ΠΕΡΙΟΧΗΣ).

ΑΥΤΗ Η ΕΓΓΥΗΣΗ ΚΑΙ ΟΙ ΔΙΑΤΑΞΕΙΣ ΤΗΣ ΕΙΝΑΙ ΑΠΟΚΛΕΙΣΤΙΚΕΣ - ΣΤΟ ΜΕΓΙΣΤΟ ΕΠΙΤΡΕΠΤΟ ΒΑΘΜΟ ΑΠΟ ΤΗΝ ΚΕΙΜΕΝΗ ΝΟΜΟΘΕΣΙΑ - ΚΑΙ Η ΠΑΡΟΥΣΑ ΕΓΓΥΗΣΗ ΥΠΕΡΚΕΙΤΑΙ ΟΛΩΝ ΤΩΝ ΑΛΛΩΝ ΕΓΓΥΗΣΕΩΝ, ΟΡΩΝ ΚΑΙ ΔΙΑΤΑΞΕΩΝ.

Η TP-Link σας εγγυάται ότι τα προϊόντα TP-Link που περιέχονται στην αρχική συσκευασία δεν θα παρουσιάσουν ελαττώματα ως προς τα υλικά και την κατασκευή – εφόσον χρησιμοποιηθούν σύμφωνα με τις οδηγίες της TP-Link – για το χρονικό διάστημα ισχύος της εγγύησης.

Français

Informations de sécurité

- Quand un appareil possède un interrupteur de mise sous/hors tension, cet interrupteur est l'une des possibilités de mettre l'appareil hors tension. Pour les appareils dépourvus d'interrupteur de mise sous/hors tension, l'unique possibilité de les mettre hors tension est de déconnecter leur cordon ou transformateur d'alimentation de la source électrique. Ce cordon ou le transformateur d'alimentation doit impérativement rester accessible.
- Ne pas démonter cet appareil ou tenter de le réparer, cela pourrait vous exposer à des hautes tensions électriques ou à d'autres risques. Démontez un composant scellé ou un appareil scellé annulerait aussitôt sa garantie. Pour toute réparation merci de vous adresser à nous.
- Ne pas utiliser cet appareil à proximité d'eau.

Garantie limitée TP-Link

Concerne les produits de marque TP-Link uniquement.

CETTE GARANTIE VOUS DONNE DES DROITS SPECIFIQUES, ET VOUS POUVEZ AVOIR D'AUTRES DROITS QUI PEUVENT VARIER D'UN ETAT, D'UN PAYS OU D'UNE PROVINCE A UNE AUTRE.

DANS LES LIMITES DU DROIT LOCAL, CETTE GARANTIE ET LES VOIES DE RECOURS SONT EXCLUSIVES ET REMPLACENT TOUT AUTRES GARANTIES RECOURS ET CONDITIONS.

TP-Link garantit les matériels marqués TP-Link, conditionnés dans un emballage original : contre les défauts matériels et les malfaçons, s'ils sont utilisés normalement et selon les prescriptions de TP-Link, pour une durée : inscrite sur l'emballage du produit ; à compter de la date d'achat par l'utilisateur final.

Italiano

Informazioni sulla sicurezza:

- Se il prodotto ha un pulsante ON/OFF, utilizzare il pulsante per spegnerlo ed accenderlo. Alcuni prodotti progettati per essere sempre operativi non ha pulsante ON/OFF: in questo caso agire direttamente sull'alimentatore..
- Non aprire il prodotto o tentare di ripararlo, rischio di shock ad alta tensione. L'apertura di un componente sigillato o prodotto annulla la garanzia.
- Mantenere lontano dall'acqua.

Garanzia

Esclusivamente per prodotti marchiati TP-Link.

LA PRESENTE GARANZIA CONFERISCE SPECIFICI DIRITTI LEGALI, IN AGGIUNTA AI DIRITTI PREVISTI DALLA LOCALE LEGISLAZIONE.

NEI LIMITI CONSENTITI DALLA LEGGE, LA PRESENTE GARANZIA ED I RIMEDI INDICATI SONO ESCLUSIVI ED IN LUOGO A TUTTE LE ALTRE GARANZIE, RIMEDI E CONDIZIONI.

TP-Link garantisce i soli prodotti hardware marchiati TP-Link venduti nella rispettiva confezione originale non compromessa ed utilizzati secondo le linee guida illustrate: Il periodo di tempo di validità della garanzia, nel rispetto delle normative vigenti, vale a partire dalla data riportata sulla prova d'acquisto da parte dell'utente finale.

Português

Informação de Segurança

- Quando um produto possui um botão on/off (ligado/desligado), esta é uma das formas de desligar o produto. Para produtos sem o botão on/off (ligado/desligado), a única forma de desligar completamente o produto é removendo-o da tomada elétrica ou desligando o respectivo adaptador de alimentação. O dispositivo desligado irá manter-se pronto a operar.
- Não abra este produto nem tente repará-lo; pode ficar exposto a altas voltagens perigosas e/ou a outros perigos. Abrir um componente ou produto selado anulará a garantia. Para reparação do produto, por favor, contacte-nos.
- Não utilize este produto na proximidade de água.

Garantia Limitada de Produto TP-Link

Apenas para Produtos da Marca TP-Link.

ESTA GARANTIA DÁ-LHE DIREITOS LEGAIS ESPECÍFICOS E PODERÁ TER OUTROS DIREITOS QUE VARIAM ENTRE ESTADOS (OU ENTRE PAÍSES OU PROVÍNCIAS).

ATÉ AO LIMITE PERMITIDO PELA LEI LOCAL, ESTA GARANTIA E OS RECURSOS ESTABELECIDOS NELA SÃO EXCLUSIVOS E SUBSTITUEM TODAS AS OUTRAS GARANTIAS, RECURSOS E CONDIÇÕES.

A TP-Link fornece garantia a qualquer produto da marca TP-Link contido na embalagem original do produto, contra qualquer defeito nos materiais e construção, quando o mesmo é utilizado em condições normais e de acordo com as orientações fornecidas pela TP-Link, por um período definido pelo do serviço de apoio local a partir da data de compra pelo utilizador final.

Suomi

Turvallisuustiedot

- Kun tuotteessa on virtakytke, se on yksi tapa sammuttaa tuote. Ainut keino kytkeä tuote, jossa on virtakatkaisin, täysin pois päältä on irrottaa tuote tai verkkolaite pistorasiasta. Näin irrotettu laite on kuitenkin käyttövalmis.
- Älä avaa tätä tuotetta tai yritä huoltaa sitä itse; voit altistaa vaaralliselle korkeajännitteelle ja muille vaaratekijöille. Sinetöidyn komponentin tai tuotteen avaaminen mitätöi takuun. Ota meihin yhteyttä, jos tuote on huollettava.
- Älä käytä tätä tuotetta lähellä vettä.

TP-Link rajoitettu tuotetakuu

Vain TP-Link-merkkiset tuotteet.

TÄMÄ TAKUU MYÖNTÄÄ KÄYTTÄJÄLLE TIETTYJÄ LAILLISIA OIKEUKSIA, JA HÄNELLÄ VOI OLLA MUITA OIKEUKSIA, JOTKA VAIHELEVAT OSAVALTIOITTAIN (TAI MAA- TAI ALUE-KOHTAISESTI).

SIINÄ MÄÄRIN KUIN LAKI SEN SALLII, TÄMÄ TAKUU JA SEN MUKAISET KORJAUSKEINOT OVAT YKSIINOMAISIA JA KORVAAVAT KAIKKI MUUT TAKUUT, KORJAUSKEINOT JA EHDOT.

TP-Link takaa, että TP-Link-merkinen laitteistotuote, joka saapui alkuperäisessä pakkauksessa, ei sisällä materiaali- eikä valmistusvirheitä normaalissa, TP-Linkin ohjeiden mukaisessa käytössä tietynä paikallisesta palvelusta riippuvana aikana siitä päivämäärästä lukien, jona loppukäyttäjät sen alun perin hankki.

Nederlands

Veiligheidsinformatie

- Als een product een aan/uit toets heeft, biedt die één mogelijkheid om het product uit te schakelen. Bij producten zonder aan/uit toets is de enige manier om het product volledig uit te schakelen het product of de netspanningadapter van de stroomtoevoer af te koppelen. Het afgekoppelde apparaat moet normaal kunnen worden gebruikt.
- Dit product niet openmaken of er onderhoud aan proberen te verrichten; u kunt blootgesteld worden aan gevaarlijke hoogspanning of andere risico's. Door het openmaken van een verzegelde component of verzegeld(e) product(en) komt de garantie te vervallen. Voor product service kunt u contact met ons opnemen.
- Dit product niet in de buurt van water gebruiken.

TP-Link beperkte productgarantie

Geldt alleen voor producten van het merk TP-Link.

DEZE GARANTIE GEEFT U SPECIFIEKE WETTELIJKE RECHTEN EN U KUNT NOG ANDERE RECHTEN HEBBEN, DIE PER LAND (OF PER PROVINCIE) KUNNEN VERSCHILLEN.

VOOR ZOVER TOEGESTAAN DOOR DE PLAATSELIJKE WETGEVING ZIJN DEZE GARANTIE EN HET VERMELDE VERHAAL EXCLUSIEF EN KOMEN DIE IN DE PLAATS VAN ALLE ANDERE GARANTIES, VERHALEN EN VOORWAARDEN.

TP-Link geeft garantie op het hardware product van het merk TP-Link in de originele verpakking voor gebreken in materialen en fabricage indien normaal gebruikt in overeenstemming met de richtlijnen van TP-Link gedurende een bepaalde periode afhankelijk van de service ter plaatse vanaf de oorspronkelijke datum van aanschaf via de detailhandel door de eindgebruiker-koper.

Svenska

Säkerhetsinformation

- Om en produkt har en strömbrytare (power on/off) är det ett av sätten att stänga av produkten. Produkter som inte har strömbrytare kan enbart stängas av genom att koppla från produkten eller nätadaptern från strömkällan. Den frånkopplade enheten ska fortsätta vara driftsklar.
- Försök inte öppna produkten eller utföra service på den, det kan utsätta dig för farlig spänning eller andra risker. Att öppna en försluten komponent eller produkt upphäver garantin. Kontakta oss för service.
- Använd inte produkten nära vatten.

TP-Link begränsad produktgaranti

Enbart för produkter av märket TP-Link.

DEN HÅR GARANTIN GER DIG SPECIFIKA FORMELLA RÄTTIGHETER OCH DU KAN HA ANDRA RÄTTIGHETER SOM VARIERAR FRÅN LAND TILL LAND (ELLER STAT ELLER PROVINS).

I DEN OMFATTNING SOM LOKALA LAGAR TILLÅTER ÅR DENNA GARANTI OCH GOTTGÖRANDEN EKSKLUSIVA OCH I STÄLLET FÖR ALLA ANDRA GARANTIER, GOTTGÖRANDEN OCH VILLKÖR.

TP-Link garanterar maskinvara av märket TP-Link i sin originalförpackning mot defekter i material eller sammansättning vid normal användning enligt TP-Links riktlinjer och under en period beroende på lokal underhållsservice baserat från ursprungliga inköpsdatumet för slutanvändaren.

Norsk

Sikkerhetsinformasjon

- Når et produkt har en strømknapp, kan denne brukes til å slå produktet av. Den eneste måten å slå av produkter uten bruk av strømknappen, er å koble produktet fra strømadapteren eller koble den fra stikkkontakten. Den frakoblede enheten skal være driftsklar.
- Dette produktet må ikke åpnes eller forsøkes reparert; slike handlinger kan utsette deg for farlig høyspenning og andre farer. Garantien oppheves hvis en forseglest komponent eller et forseglest produkt åpnes. Kontakt oss i tilfelle produktet trenger vedlikehold.
- Ikke bruk dette produktet i nærheten av vann.

TP-Links begrensede produktgaranti

Gjelder kun for produkter merket TP-Link.

DENNE GARANTIE GIR DEG SPESIFISERTE, RETTSLIGE RETTIGHETER, OG I TILLEGG KAN DU HA ANDRE RETTIGHETER SOM VARIERER MED JURISDIKSJON (ETTER LAND).

I DEN UTSTREKNING DET ER TILLATT I HENHOLD TIL LOKAL LOV ER DENNE GARANTIE OCH LØSNINGENE SOM HER ER FREMSATT EKSKLUSIVE OG ERSTATTER ALLE ANDRE GARANTIER, LØSNINGER OG BETINGELSER.

TP-Link garanterer at det TP-Link-merkede maskinvarerproduktet som ligger i den originale emballasjen er fri for feil i materialer og utførelse når det brukes på normal måte i samsvar med TP-Links retningslinjer i en periode som avhenger av lokale forhold fra den datoen sluttbrukeren opprinnelig kjøpte produktet fra en forhandler.

Dansk

Sikkerhedsinformation

- Du kan tænde/slukke for enheden ved at benytte Tænd/Sluk knappen. På produkter der ikke er udstyret med en Tænd/Sluk knap, er den eneste måde at afbryde enheden på, at udtrække ledningen eller adapteren til strømkilden. Den afbrudte enhed skal forblive klar til brug.
- Undlad at åbne enheden eller forsøge at reparere det. Du vil være udsat for højspænding eller andre risici. Hvis du åbner en forseglest komponent eller produkt(er) bortfalder garantien. Hvis du har brug for vedligeholdelse, bedes du kontakte os.
- Undlad at benytte enheden i nærheden af vand.

TP-Link begrænset produktgaranti

Gælder kun TP-Link mærkevarer.

DENNE GARANTI GIVER DIG SPECIFIKKE JURIDISKE RETTIGHEDER OG DU KAN HAVE ANDRE RETTIGHEDER SOM VARIERER FRA STAT TIL STAT (ELLER FRA LAND ELLER PROVINS).

INDENFOR LOVENS RAMMER ER GARANTIE OCH RETSMIDLERNE DER FREMGÅR EKSKLUSIVE OG I STEDET FOR ALLE ANDRE RETTIGHEDER, RETSMIDLER OG BETINGELSER.

TP-Link garanterer at alle TP-Link hardware produkter indeholdt i den originale emballage ikke er behæftede med fejl på materialer og håndværk såfremt de bruges efter hensigten og i overensstemmelse med TP-Link's retningslinjer, indenfor en periode som afhænger af den lokale service, fra købsdatoen af den oprindelige slutbruger/køber.

TP-Link Technologies Co., Ltd.

South Building(floors 1,3,4,5) and 28(floors 1-4), Central Science & Technology Park, Shennan Rd, Nanshan, Shenzhen, China

TP-Link Deutschland GmbH

Robert-Bosch-Straße 9, 65719 Hofheim am Taunus, Germany

TP-Link UK Limited

Unit 2 & 3 Riverview (142-144), Cardiff Road, Reading, RG1 8EW

TP-Link Italia S.r.l.

Via Gobetti 2/A 20063 Cernusco sul Naviglio (MI)

TP-Link France SARL

Bâtiment Equateur, 16-18 avenue Morane Saulnier, 78140, Vélizy-Villacoublay, France

TP-Link Bilgi Teknolojileri Tic. Ltd. Şti.

Şerifali Mevkii, Barbaros Cad. Söyleşi Sokak. No:15/2 Kat:3/4 34775 Ümraniye/İstanbul

TP-Link IBERIA,S.L.

Calle Quintanavides 17, 3ºE, 28050 Madrid, Spain

TP-Link Netherlands B.V.

Archimedesbaan 18, 3439 ME Nieuwegein

TP-Link(NORDIC) AB

Forumvägen 14, Plan 13 131 53 Nacka, Sweden

TP-Link Hellas Ltd.

Marathonodromou 77, Marousi 151 24, Greece

NWS.TP-Link Portugal, Unipessoal, Lda.

Avenida da Liberdade, nº129, 7ºB,1250-140 Lisboa, Portugal



For more information and technical support, please visit

<http://www.tp-link.com/support>.