



# EtherHaul-1200™

Gigabit Ethernet Wireless Solution

## Installation Manual



EH1200-INST-04, Issue 2

**February 2015**

### **Trademarks**

Siklu, the Siklu logo, and EtherHaul are all trademarks of Siklu Communication Ltd.

All other product names and trademarks mentioned in this document are trademarks or registered trademarks of their respective companies.

### **Copyrights**

**Copyright © 2014 Siklu Communication Ltd. All rights reserved.**

No part of this publication may be reproduced or distributed in any form or by any means, or stored in a database or retrieval system, without the prior written consent of Siklu.

### **Disclaimers**

The information contained in this document is subject to change without notice.

Siklu assumes no responsibility for any errors that may appear. Siklu makes no warranties, expressed or implied, by operation of law or otherwise, relating to this document, the products or the computer software programs described herein.

This document was originally written in English. Please refer to the English language version for a full and accurate description of all products and services described herein.

## Safety and Regulatory Notices

The following are mandatory notices for installation and operation of EtherHaul Wireless Backhaul Link. Indications appearing here are required by the designated government and regulatory agencies for purposes of safety and compliance.

### General

Do not install or operate this System in the presence of flammable gases or fumes. Operating any electrical instrument in such an environment is a safety hazard.

### European Commission

This product has been designed to comply with CE markings in accordance with the requirements of European Directive 1995/5/EC.

This product has been designed to comply with the requirements of European Directives.

This equipment must be permanently earthed for protection and functional purposes. To make a protective earth connection, use the grounding point located on the System ODU using a minimum amount of 16AWG grounding cable or according to local electrical code.

This apparatus is intended to be accessible only to authorized personnel. Failure to prevent access by unauthorized personnel will invalidate any approval given to this apparatus.

This product is in full compliance with the following standards:

- RF                                EN 302 217-3 1.3.1  
    E-Band FCC part 101
- EMC                                EN 301 489-4
- Safety                              IEC 60950
- Operation                        EN 300 019-1-4 Class 4.1E
- Storage                            EN 300 019-1-1 Class 1.2
- Transportation                EN 300 019-1-2 Class 2.2

### FCC/IC Regulatory Statements

This equipment has been tested and found to comply with the limits for a Class B digital device, pursuant to Part 15 of the FCC Rules and IC RSS standards. These limits are designed to provide reasonable protection against harmful interference in a residential installation. This equipment generates uses and can radiate radio frequency energy and, if not installed and used in accordance with the instructions, may cause harmful interference to radio communications. However, there is no guarantee that interference will not occur in a particular installation. If this equipment does cause harmful

interference to radio or television reception, which can be determined by turning the equipment off and on, the user is encouraged to try to correct the interference by one or more of the following measures:

- Reorient or relocate the receiving antenna.
- Increase the separation between the equipment and receiver.
- Connect the equipment into an outlet on a circuit different from that to which the receiver is connected.
- Consult the dealer or an experienced radio/TV technician for help.

**Note:**  Changes or modifications to this equipment not expressly approved by Siklu LTD or the party responsible for compliance could void the user's authority to operate the equipment.

**Caution:**  Outdoor units and antennas should be installed **ONLY** by experienced installation professionals who are familiar with local building and safety codes and, wherever applicable, are licensed by the appropriate government regulatory authorities. Failure to do so may void the product warranty and may expose the end user or the service provider to legal and financial liabilities. Siklu LTD and its resellers or distributors are not liable for injury, damage or violation of regulations associated with the installation of outdoor units or antennas.

**Prudence:** Les unités extérieures et les antennes doivent être installés que par des professionnels expérimentés d'installation qui sont familiers avec les norms locales et les codes de sécurité et, si applicable, sont agréées par les autorités gouvernementales de réglementation compétents. Ne pas le faire peut annuler la garantie du produit et peuvent exposer l'utilisateur final ou le fournisseur de services d'obligations juridiques et financiers. Revendeurs ou distributeurs de ces équipements ne sont pas responsables des blessures, des dommages ou violation des règlements liés à l'installation des unités extérieures ou des antennes. L'installateur doit configurer le niveau de puissance de sortie des antennes conformément aux réglementations nationales et le type d'antenne.

## About this Document

This document is the Installation Manual for the EtherHaul-1200F wireless Link.

It provides product overview and details the installation and initial setup.

For instructions how to use the product's features, refer to the "EtherHaul Operation, Administration and Maintenance Manual".

**Note:**



Features and functionality described in this document may be available for specific product models or starting from specific SW version.

Please review the individual product's release notes to verify if a specific feature is supported in the product you use.

## Applicable Products and Releases

- E-Band
  - EH-1200, minimum SW release 3.5.0
  - EH-1200TL, minimum SW release 3.5.0

## Audience

This document assumes a working knowledge of wireless backhaul platforms and their operating environments.

This document is intended for use by all persons who are involved in planning, installing, configuring, and using the EtherHaul system.

## Conventions

The following conventions are used in this document in order to make locating, reading, and using information easier.

### *Special Attention*

**Hint:**



Informs you of a helpful optional activity that may be performed at the current operating stage.

**Note:**



Provides important and useful information or describes an activity or situation that may or will interrupt normal operation of the EtherHaul system, one of its components, or the network.

**Caution:**



Describes an activity or situation that requires special attention.

*Text Conventions*

*Document References*

Italicized text is used to reference sections or chapters in this document. In many cases, references use clickable hypertext links that enable immediate access to referenced objects.

**Command Input**

Monospace text is used to help delineate command line user input or text displayed in a command window.

# TABLE OF CONTENTS

<b>1</b>	<b>Introduction to the EtherHaul System.....</b>	<b>10</b>
1.1	Main Features .....	11
1.2	Functional Description .....	13
1.3	Technical Specifications.....	14
1.4	Licensing .....	15
1.5	Management .....	15
<b>2</b>	<b>Installing the EtherHaul System .....</b>	<b>17</b>
2.1	Preparing the Site.....	17
2.1.1	Physical and Environmental Requirements.....	18
2.1.2	Cabling Requirements.....	18
2.2	EtherHaul Package Content.....	19
2.3	Unpacking the EtherHaul .....	19
2.4	Required Tools.....	20
2.5	Preparing for Installation.....	20
2.6	Mounting the EtherHaul .....	21
2.7	Installing the ODU with a Two Foot Antenna.....	23
2.8	Connecting the Cables.....	25
2.8.1	Power Options .....	25
2.8.2	DC Power Supply Notes .....	26
2.8.3	Grounding the EtherHaul .....	27
2.8.4	Preparing the Cables .....	28
2.8.5	Removing Connectors from the EtherHaul ODU.....	29
2.8.6	Connecting DC Power .....	29
2.8.7	Connecting Other Interfaces.....	29
2.9	System LEDs .....	30
2.10	Aligning the Antenna .....	30
2.10.1	Setting the ODU to Alignment Mode .....	31
2.10.2	Performing the Alignment .....	31
2.11	Link Up Verification .....	32
<b>3</b>	<b>Performing Basic Setup Using the Web-Based Management.....</b>	<b>34</b>
3.1	Connecting to the ODU Using the Web-Based Management .....	35
3.2	Main Page.....	36
3.3	General Configuration Commands .....	38
3.3.1	Apply .....	38
3.3.2	Save Configuration.....	38

3.3.3	Rollback .....	38
3.3.4	Reset .....	39
3.3.5	Copy To Remote .....	39
3.4	Quick Configuration Wizard .....	40
3.4.1	Quick Configuration: Step 1 – System .....	40
3.4.2	Quick Configuration: Step 2 – Radio .....	40
3.4.3	Quick Configuration: Step 3 – Eth Ports .....	42
3.4.4	Quick Configuration: Step 4 – Network .....	43
3.5	Radio Page.....	44
3.5.1	Settings .....	44
3.5.2	Advanced Settings .....	46
3.5.3	Maintenance .....	47
3.5.4	Modulation Table .....	48
3.5.5	Statistics .....	48
3.6	Default Bridge Configuration .....	49
<b>4</b>	<b>Commissioning and Acceptance Procedure.....</b>	<b>50</b>
4.1	Installation Verification and Testing.....	50
4.1.1	Physical Installation Verification .....	50
4.1.2	RF Link Test .....	50
4.1.3	Link Errors Test.....	50
4.1.4	Ethernet Services Test .....	51
4.1.5	Management Verification .....	51
4.1.6	Recording ODU Configuration .....	51
4.2	EtherHaul Commissioning and Acceptance Form.....	51



## TABLE OF FIGURES

Figure 1-1 Hitless Adaptive Bandwidth, Coding and Modulation .....	13
Figure 1-2 EH-1200 (TDD) Functional Block Diagram .....	14
Figure 2-1 EtherHaul Mounting Assembly Components .....	21
Figure 2-2 Quick Release Hooks .....	22
Figure 2-3 EtherHaul ODU for 2ft Antenna .....	23
Figure 2-4 EtherHaul ODU installed on 2ft Antenna .....	23
Figure 2-5 EtherHaul Connection Panel Details .....	25
Figure 2-6 DC Connector .....	25
Figure 2-7 Grounding Scheme .....	27
Figure 2-8 All-Weather Connecting Cable Shell Assembly .....	28
Figure 3-1 Launching the Web-Based Management .....	35
Figure 3-2 Entering Username and Password .....	35
Figure 3-3 Web-Based Management Main Page .....	35
Figure 3-4 Copy To-Remote icon .....	39
Figure 3-5 Quick Config Page: Step 1 - System .....	40
Figure 3-6 Quick Config Page: Step 2 - Radio .....	40
Figure 3-7 Quick Config Page: Step 3 – Eth Ports .....	42
Figure 3-8 Quick Config Page: Step 4 – Network .....	43
Figure 3-9 Radio Page: Settings .....	44
Figure 3-10 Radio Page: Advanced Settings .....	46
Figure 3-11 Radio Page: Maintenance .....	47
Figure 3-12 Radio Page: Modulation Table .....	48

# 1 Introduction to the EtherHaul System

This chapter provides a brief overview of the EtherHaul product line.

The EtherHaul 1200 product line delivers carrier-grade wireless point-to-point gigabit Ethernet services utilizing the light-licensed 71-76Hz E-band spectrum (TDD).

The EtherHaul is based on Siklu's revolutionary integrated-silicon technology, which results in a highly reliable, zero footprint, and low-cost radio.

The EtherHaul offers Gigabit throughput, MEF-compliant networking, 8 levels of QoS, enhanced Hitless Adaptive Bandwidth, Coding & Modulation for maximum spectral efficiency, and services availability. It supports network synchronization, advanced OAM&PM tools and ring protection optimized for both small cell and mobile backhaul. It features multiple GbE interfaces, including optical, supporting complex network topologies, such as daisy chain, ring, and mesh. The multiple ports enable also colocation installation and leveraging the infrastructure for additional fixed services delivery. The EtherHaul is fast, simple and inexpensive to deploy.

EtherHaul as the ideal solution for mobile backhaul and business services delivery features:

- Field proven technology
- Reduced TCO and fast ROI
- All-outdoor invisible footprint
  - Small and light
  - Quick and easy to install
- Spectral efficient
  - Wide range of frequencies
  - TDD modulation with seamless delay and jitter
  - Hitless Adaptive Bandwidth Coding and Modulation for high availability
- Advanced layer-2 features:
  - MEF-compliant services and QoS
  - VLAN & Provider Bridge with 16K jumbo frames support
    - Clear separation between multiple services with QoS
    - Enables QoS aware MPLS services delivery
  - SLA assurance
- Advanced AES encryption for secured street level deployments

Highly-scalable, the EtherHaul products are software-upgradable to support future Layer 2.5/3 networking and routing capabilities as networks evolve to flat-IP topologies.

The EtherHaul products features advanced adaptive modulation, bandwidth and coding - allowing operators to maintain, prioritize, and verify QoS in all weather conditions, while achieving maximum (up to 99.999%) link availability for prioritized services such as voice signaling and Sync.

Offering easy and low cost all-outdoor installation and a small form factor, the EtherHaul products are also environmentally-friendly - boasting a small system and antenna footprint with especially low power consumption.

The EtherHaul systems are High-capacity Gigabit Ethernet backhaul, with advanced networking capabilities, at the lowest TCO in the industry. EtherHaul enables mobile operators to profitably and reliably provide data intensive services. Provided by Siklu, the pioneer in silicon based mm-waves backhaul systems, EtherHaul systems are the perfect choice for future proof investment.

## 1.1 Main Features

Siklu's EtherHaul wireless backhaul radio link operates in the new V-band and E-band spectrum, which provides clear technological and economic advantages over the existing lower frequency bands. Taking advantage of the new spectrum, the EtherHaul enables easy migration to support Gigabit throughput, enabling operators to enhance bandwidth capacity on a "pay as you grow" basis. Supporting point-to-point, daisy-chain, ring, and mesh configurations, the EtherHaul system offers carrier class availability and services.

The following are some of the main features of the EtherHaul (availability of features depends on platform):

### All-Outdoor Packet Radio

- Operates in the light-licensed 71-76 GHz E-Band
- Up to 1 Gbps throughput
- Asymmetric capacity configuration
- High gain narrow beam-width directional antenna
- Low latency

### Highest Spectral Efficiency

- 500 MHz channel bandwidth
- Advanced hitless/errorless Adaptive Bandwidth, Coding and Modulation (ABCM) for a large dynamic range
- Configurable center frequency across the entire band

**Carrier Ethernet Inside:**

- Integrated Gigabit Ethernet switch
- Advanced bandwidth-aware QoS capabilities
- MEF compliant services and QoS
- Advanced service management, OAM and SLA assurance support
- SyncE and optimized transport of IEEE 1588
- Ring, mesh and daisy chain topologies for carrier grade availability and resiliency
- Standard-based for seamless integration into existing networks and multi-vendor interoperability
- Multi-vendor interoperability approved

**Carrier Grade:**

- CLI, SNMP and web-based local and remote management
- Extremely high reliability with very high MTBF
- Designed for ultra-low MTTR without the need for antenna realignment

**Green Design:**

- Zero footprint, all-outdoor, extremely light weight
- low power consumption
- IEEE 802.3at complaint Power over Ethernet

**Quick and Easy Installation**

- Rapid and flexible deployment
- Precise antenna alignment
- Minimal site preparation

**Security**

- Advanced AES encryption and security
- Narrow and secure beam-width

**Adaptive Bandwidth, Coding and Modulation**

The EtherHaul family implements hitless/errorless adaptive bandwidth, coding and modulation adjustment to optimize the over-the-air transmission and prevent weather-related fading from disrupting traffic on the link. The EtherHaul can gain up to 21 dB in link budget by dynamically adapting: Modulation, FEC coding rates, and channel bandwidth maintaining the high priority traffic using quality of service advanced mechanism and dropping the traffic according to the QoS priority defined by the user.

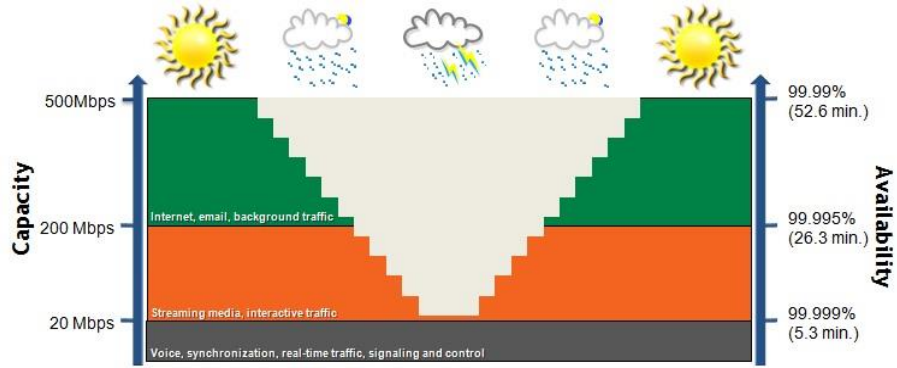

Figure 1-1 Hitless Adaptive Bandwidth, Coding and Modulation

## 1.2 Functional Description

The EtherHaul is an all-outdoor system comprised of the following functional blocks:

- RFIC: Siklu’s integrated Silicon Germanium (SiGe) transceiver operating at 57-66GHz (EH-600T), 71-76GHz (EH-1200/EH-1200TL) or 71-76/81-86GHz (EH-1200F/EH-1200FX).
- Modem/Baseband ASIC: Siklu’s modem/baseband ASIC includes the modem, FEC engines, and Synchronous Ethernet support.
- Network Processor: the networking engine is the heart of the high speed bridge/router function. The engine receives packets from Ethernet interfaces the modem and CPU. It is responsible for proper forwarding between these all interfaces.
- Interfaces: The network interface consists of 2-4 integrated 100/1000 Ethernet ports, depends on the product type.
- Host processor (CPU) the host processor controls the system responsible for the control plane, and the antenna alignment.
- Antenna: Siklu’s self-designed 1ft innovative antenna, as well as 2ft antenna option for longer range higher availability.

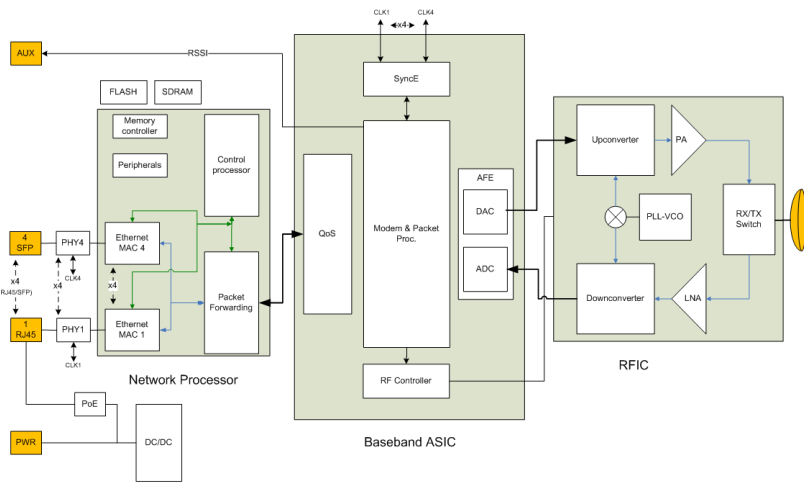

Figure 1-2 EH-1200 (TDD) Functional Block Diagram

### 1.3 Technical Specifications

For detailed technical specifications please refer to the datasheet.  
 For detailed supported features list please refer to the product’s release notes.

EtherHaul-1200F	
Technology and frequency	<ul style="list-style-type: none"> <li>TDD, 71-76/81-86GHz</li> </ul>
Modulation	<ul style="list-style-type: none"> <li>QPSK/QAM16/QAM64</li> </ul>
Adaptive modulation	<ul style="list-style-type: none"> <li>Hitless adaptive bandwidth, coding and modulation, boosting system gain by 25dB</li> </ul>
Over-the-air throughput	<ul style="list-style-type: none"> <li>Up to 1000Mbps Aggregated duplex</li> </ul>
Typical link distance	<ul style="list-style-type: none"> <li>Up to 4500m (maximum 7000m)</li> </ul>
Interfaces	<ul style="list-style-type: none"> <li>2xGE - 2xCopper or SFP ports (combo ports)</li> </ul>
Antenna	<ul style="list-style-type: none"> <li>Integrated 1ft (31cm) Cassegrain reflector - 43dBi antenna gain,</li> <li>External 2ft (65cm) Cassegrain reflector -50dBi antenna gain</li> </ul>
Power options	<ul style="list-style-type: none"> <li>PoE+ (IEEE 802.3at)</li> <li>Direct Telco DC: ±21-57VDC</li> </ul>
Ethernet features	<ul style="list-style-type: none"> <li>VLAN (IEEE 802.1q) and VLAN stacking (Q-in-Q, IEEE 802.1ad Provider Bridge)</li> <li>IEEE 802.1d Transparent Bridging</li> <li>Advanced QoS &amp; Traffic management- 802.1p, DSCP &amp; MPLS EXP                             <ul style="list-style-type: none"> <li>Scheduling , Shaping, Policing</li> </ul> </li> <li>MEF 9,14 and 21 compliant</li> <li>Ethernet OAM and CFM (IEEE 802.1ag / ITU-T Y.1731 / IEEE 802.3ah)</li> </ul>

	<ul style="list-style-type: none"> <li>• Ethernet Ring Protection (ITU-T G.8032)</li> <li>• MAC learning</li> <li>• Link state propagation</li> <li>• Jumbo frames</li> </ul>
Synchronization	<ul style="list-style-type: none"> <li>• Synchronous Ethernet ITU-T G.8261/8262/8264</li> </ul>
Network topologies	<ul style="list-style-type: none"> <li>• Ring, daisy-chain and mesh</li> </ul>
Encryption	<ul style="list-style-type: none"> <li>• AES 128-bit and 256-bit</li> </ul>
Management	<ul style="list-style-type: none"> <li>• In-band, out-of-band, embedded CLI, web GUI, SNMPv2/3</li> </ul>
System modes	<ul style="list-style-type: none"> <li>• Adaptive modulation</li> <li>• Symmetrical uplink/downlink ratio or Asymmetrical</li> <li>• Alignment</li> </ul>
Environmental	<ul style="list-style-type: none"> <li>• Operating temperature: -45° ÷ +50°C</li> <li>• Ingress protection rating: IP67</li> </ul>
Dimensions and Weight	<ul style="list-style-type: none"> <li>• 24.5 cm x 22.5 cm x 7 cm</li> <li>• ODU + 1ft Antenna (Dia. x Depth) -31 cm x 13 cm</li> <li>• Weight ODU + antenna (1ft): 4 kg</li> </ul>

## 1.4 Licensing

The EtherHaul family provides for easy migration to support Gigabit throughput, enabling operators to enhance bandwidth capacity on a “pay as you grow” basis as well as adding features and capabilities according to their networks evolutions. You can order the following EtherHaul software (capacity steps and feature availability depend on your platform):

- Data rates
- Layer 2 networking capabilities – OAM and Resiliency
- Synchronization – Synchronous Ethernet (ITU-T G.8261) and IEE-1588TC
- Encryption.

Vlan configuration and Provider-Bridge settings capabilities are enabled by default and do not require a license.

The software licenses are serial number dependent.

## 1.5 Management

You can manage an EtherHaul system using a Web-Based Element Management System (Web EMS) or a Command Line Interface (CLI). The CLI is compatible with SNMP.

Advanced network features must be managed using the CLI.

The EtherHaul system features a wide range of built-in indicators and diagnostic tools for advanced OAM functionality. The system is designed to enable quick evaluation, identification, and resolution of operating faults.



## 2 Installing the EtherHaul System

This chapter describes how to install and perform the basic setup for EtherHaul outdoor unit (ODU) in an EtherHaul wireless network, including:

- Preparing the Site
- EtherHaul Package Content
- Unpacking the EtherHaul
- Required Tools
- Preparing for Installation
- Mounting the EtherHaul
- Installing the ODU with a Two Foot Antenna
- Connecting the Cables
- System LEDs
- Aligning the Antenna
- Link Up Verification

The installation of the EtherHaul system is followed by initial system setup that will be described in the next chapter.

**Caution:**



The installation and maintenance of the EtherHaul link should only be done by service personnel who are properly trained and certified to carry out such activities.

**Caution:**



It is the responsibility of the installer to insure that when using the outdoor antenna kits in the United States (or where FCC rules apply), only those antennas certified with the product are used. The use of any antenna other than those certified with the product is expressly forbidden in accordance to FCC rules CFR47 part 15.204.

### 2.1 Preparing the Site

Carefully select and prepare each EtherHaul ODU site to make device installation and configuration as simple and trouble-free as possible. During site selection and preparation, always consider the long-term needs of both your network and your applications.

## 2.1.1 Physical and Environmental Requirements

Each EtherHaul ODU site should adhere to the following requirements:

- There must be a clear, unobstructed line-of-sight between ODU.
- The EtherHaul ODU should be mounted on a fixed, stable, permanent structure. A reinforced steel mounting pole is required, with a diameter measuring from 2-4 inches (1ft antenna) or 2-4.5 inches (2ft antenna).

### Caution:



Do not mount the EtherHaul device on a structure that is temporary or easily moved. Doing so may result in poor service or equipment damage.

- You must mount the EtherHaul ODU in a site that is easily accessible to authorized personnel, and only authorized personnel.
- Operating temperature: between -45° and +55°C.
- Relative humidity: 0 to 100%.
- Maximum altitude: 4,500m.
- Ingress Protection rating: IP67.

## 2.1.2 Cabling Requirements

- Ensure that your power connection cable matches the EtherHaul power connector pin-outs.
- Install the EtherHaul ODU where network connections and optional power cabling are ready for operation and easily accessible.
- All cabling connected to the ODU should be outdoor-grade, with UV protection.
- Use a two-wire cable (14-18 AWG) to connect the power supply to the ODU.
- You should use shielded outdoor Cat5e cables terminated with metallic RJ45 connectors.
- In order to protect indoor equipment, you must install surge protection circuits on all copper cables on their entrance to the building.
- Install the EtherHaul ODU in a location where proper electrical outdoor grounding is readily available. Typically, the grounding connection is attached directly to the mounting pole. If not already present, then suitable structure-to-earth grounding connections must be created before installation. Ground the ODU using a minimum quantity of 16AWG grounding cable or according to local electrical code.

**Caution:** Improper electrical grounding can result in excessive electromagnetic interference or electrical discharge.



Siklu will not be held responsible for any malfunction or damage in the event that the ODU is not properly grounded.

## 2.2 EtherHaul Package Content

An EtherHaul link consists of two ODUs and two mounting assemblies.

The EtherHaul packages include the following components:

Package	Description	EH 600T Quantity	
EtherHaul-1200 ODU			
	EtherHaul 1200 ODU with 1ft integrated antenna	1	
	Connecting cable All-Weather shells	3	
	Unit grounding cable (90 cm)	1	
	DC cable terminal block connector	1	
EtherHaul 1200 mounting assembly			
	EtherHaul 1200 mounting assembly	1	

## 2.3 Unpacking the EtherHaul

The EtherHaul package content should be examined carefully before installation.

When you unpack the components of the EtherHaul, it is important to use care so as to avoid damaging or scratching the antenna radome:

- Do not touch the radome when unpacking the ODU.
- Do not rest the ODU face down or touch the radome. It is crucial to prevent contact between the radome and other objects.

## 2.4 Required Tools

Ensure that you have the following tools with you when performing an EtherHaul installation:

- Standard handheld digital voltage meter (DVM) with probes
- Standard open-end wrench, 13 millimeter
- 8mm Allen key for ODU installation with 2ft antenna
- Philips screwdriver, medium size head for grounding connection
- Flat-head screwdriver, small size (2mm) head for DC connector
- Cable ties (for securing network and optional power cables)
- Cutter
- Cable labeling

## 2.5 Preparing for Installation

The expected receive signal strength should be calculated prior to installing the link for each antenna ODU (read from the DVM) prior to installation, based on the network link budget.

Calculating the expected RSSI:

$$\text{RSSI} = P_{\text{tx}} + G_{\text{ant1}} - \text{LFS} - \text{Att}_{\text{atm}} + G_{\text{ant2}}$$

Where:

- $P_{\text{tx}}$  – ODU's Tx Power (typically +5dBm)
- $G_{\text{ant1}}$  – Gain of antenna 1 (typically 35dBi)
- $G_{\text{ant2}}$  – Gain of antenna 2 (typically 35dBi)
- $\text{LFS}$  – Loss of Free Space =  $92.45 + 20 * \text{Log}(D_{\text{km}} * F_{\text{GHz}})$ 
  - $D$  - Link distance in Km
  - $F$  – Frequency in GHz
- $\text{Att}_{\text{atm}}$  – Attenuation due to Atmospheric Gases (dB/Km)

For E-band links, the Attenuation due to Atmospheric Gases is typically 0.5dB/Km.

For V-band links, the Attenuation due to Atmospheric Gases is significantly higher (up to 15dB/Km) and depends on the specific channel used and the exact geographical location.

Refer to EtherHaul Link Budget Calculator for on-line calculation of expected availability and expected RSSI.

## 2.6 Mounting the EtherHaul

**Note:**



- These instructions are for mounting a system with a one-foot antenna. For instructions on mounting the EtherHaul 1200 with a two-foot antenna, refer to *Installing the ODU with a Two Foot Antenna*.
- Torque level for tightening the nuts and bolts is 8nm.

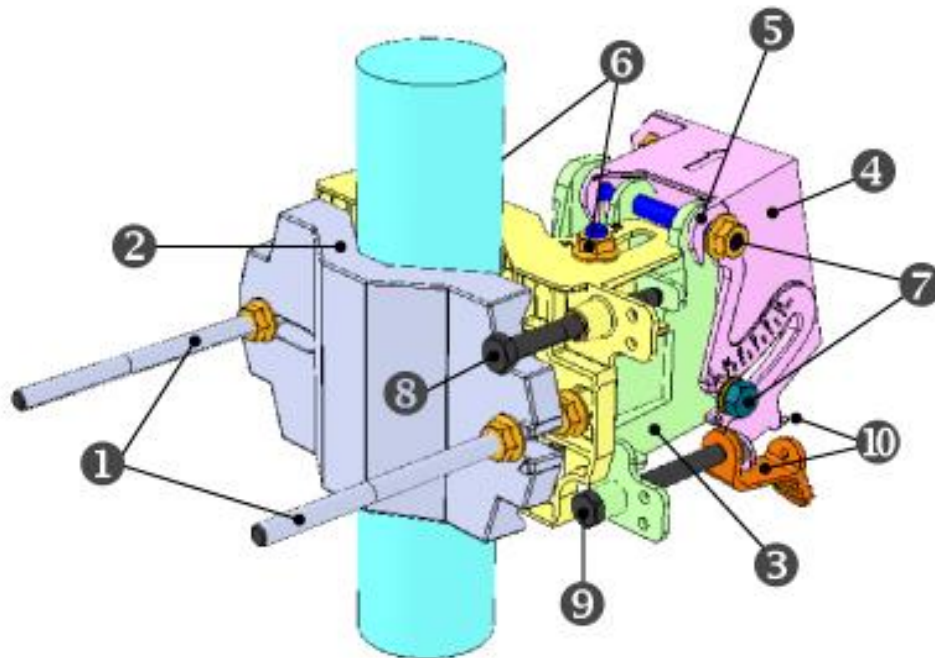

- |  |   |
|--|---|
| 1. Unit mounting screws and bolts        | 6. Azimuth adjustment lock bolts                      |
| 2. Back mounting bracket                 | 7. Elevation adjustment lock bolts                    |
| 3. Front mounting bracket                | 8. Azimuth fine adjustment screw ( $\pm 8^\circ$ )    |
| 4. Quick release plate (attached to ODU) | 9. Elevation fine adjustment screw ( $\pm 16^\circ$ ) |
| 5. Quick release hooks                   | 10. Elevation screw tension band and pin              |

*Figure 2-1 EtherHaul Mounting Assembly Components*

1. Prior to mounting, unpack the mounting kit package and attach the two unit mounting screws (1) to the front mounting bracket (3), securing them with mounting bolts.
2. Assemble the back (2) mounting bracket to the front (3) mounting bracket using one bolt and separate them by about 120 degrees so that the assembly can be attached to the mounting pole.
3. Place the assembly on the mounting pole and rotate the front and back mounting brackets to close the assembly on the pole. Replace the unit mounting bolt that was removed.
4. Ensure that both front and back mounting brackets are attached evenly to the pole, and are completely level.

5. Use the 13mm open wrench to tighten the nuts on both unit mounting bolts. Temporarily tighten the unit mounting bolts at this stage to keep the unit from moving freely.
6. By default, the ODU is delivered with the quick release plate (4) securely attached in a vertical polarization. If necessary, change the ODU polarization to match the orientation of the remote ODU by removing the quick release plate, changing its orientation, and reattaching. For ease of reference, the markings V (vertical) and H (horizontal) are engraved on the back side of the ODU.
7. Examine the position scales of both the Azimuth adjustment lock bolts (6) and the elevation adjustment lock bolts (7), found on the front mounting bracket, and ensure that they are positioned at 0 degrees (in the middle of the scale).
8. Position the quick release hooks (5) onto the top elevation adjustment lock bolt (7) and carefully set the ODU in place on the front mounting bracket and slide it firmly inwards.

Mount the ODU by attaching the interior quick release hook (A) in place **before** attaching the exterior hook (B). The interior hook is the one located farthest from the tightening nut, as shown below.

Hint:

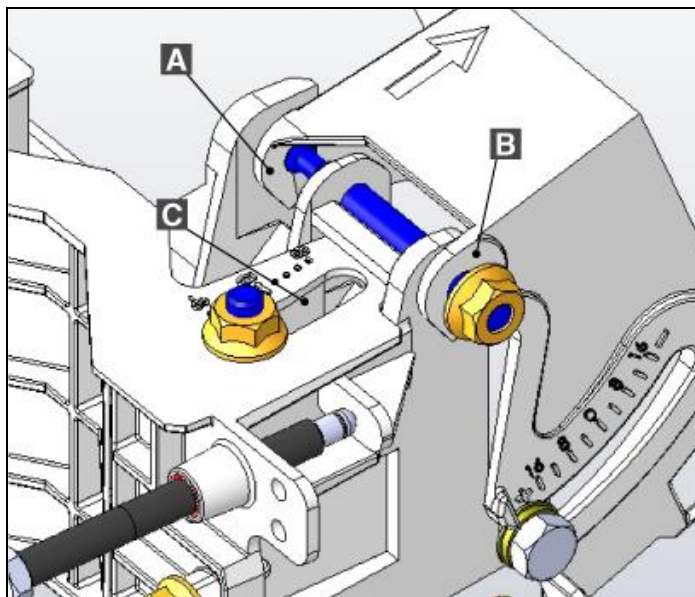

A. Interior Quick Release Hook B. Exterior Quick Release Hook C. Elevation Position Slot

*Figure 2-2 Quick Release Hooks*

9. **Unlock** the Azimuth adjustment lock bolts (6) and the elevation adjustment lock bolts (7).
10. Stretch the elevation screw tension band (10) slightly and connect it to its mating tension pin, located on the quick release plate.

## 2.7 Installing the ODU with a Two Foot Antenna

This appendix presents the installation instructions of EtherHaul 1200 ODU with a two foot antenna.

1. Install the two foot antenna according to the mounting diagram on the next page. Antenna mounting kit installation instructions are also available inside the mounting kit package.
2. Remove the protective tape on the antenna feed.

The two foot ODU is shipped with External ODU adapter attached.



Figure 2-3 EtherHaul ODU for 2ft Antenna

3. Unpack the two foot ODU and remove the protective cap.
4. Attach the ODU to the antenna and tighten the four locking bolts.
5. Make sure you install the ODU with the required polarization (note the polarization arrow on the back of the ODU).

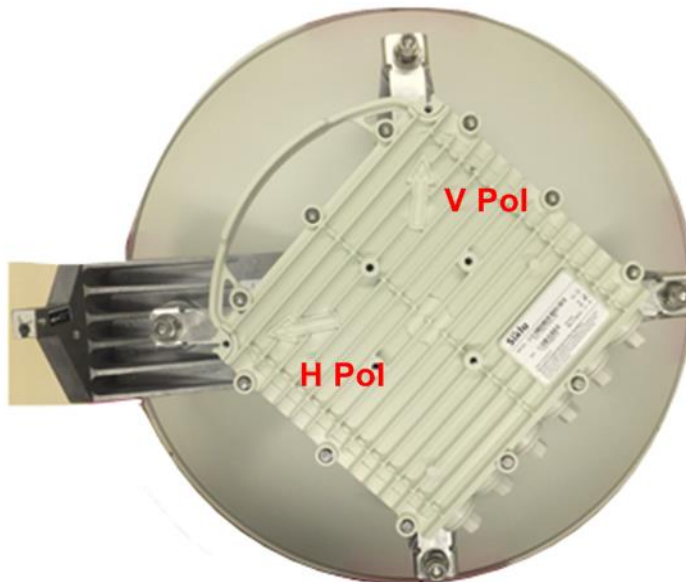

Figure 2-4 EtherHaul ODU installed on 2ft Antenna

6. Proceed with antenna alignment and ODU setup as described in section 2.10.

## INSTALLATION INSTRUCTIONS FOR MOUNTING KIT

RD43101200C/D

### Step: 1

**1** Bolt 5/16"x1-3/8" UNC  
Spring Washer 5/16"  
Flat Washer 5/16"  
6 PL.

Azimuth Adjustment Bolt 5/16

**2** Grease

Hex Nut 5/16 UNC

**3** Azimuth Lock Bolts (4 PL.)

Grease Surface Around the Slot from Both Sides

**4** Antenna Base Lock

Tilt Antenna Plate Assy

Central Bolts (2 PL.)

Hex Nut 5/16 UNC

Elevation Adjustment Bolt 5/16

**Notes:**

- Center the Azimuth Lock Bolts in slot (4 PL.)
- Use tightening torque of 4 Nm on Central Bolts (2 PL.)
- Tool required 1/2" open end or deep socket wrench.
- Use grease in marked recommended places.

### Step: 2

Mast 2"-4.5" outer diameter

**5** Mounting Lock Bolt 5/16"x6.5" UNC  
4 PL.

Holder Bracket (2 PL.)

Hex Nut 5/16" UNC  
Spring Washer 5/16"  
Flat Washer 5/16"  
4 PL.

Tilt Antenna Plate Assy

Pin

Dish Antenna Base

**6** Grease

Dish direction

**Notes:**

- Roughly aim the Mounting Kit Pin perpendicular to Dish direction
- Use tightening torque of 9 Nm on Nut of Mounting Lock Bolt (4 PL.)
- Tool required 1/2" open end or deep socket wrench.
- Use grease in marked recommended places.

### Step: 3

**7** Elevation Lock Bolt 5/16"x2" UNC  
2 PL.

Hex Nut 5/16" UNC  
Spring Washer 5/16"  
Flat Washer 5/16"  
2 PL.

Joint Lock Bolt  
Hex Head Screw  
5/16"x5/8" UNC

**Notes:**

- At any time, keep **Elevation Adjustment Bolt in parallel to the pole.**
- Adjustment Bolts must be greased at all time.
- After fine adjustment use tightening torque of 4 Nm on Azimuth Lock Bolts (4PL) and 9 Nm on Nut of Elevation Lock Bolts (2PL).
- Tool required 1/2" open end or deep socket wrench.

### Step: 4

**8** Joint Lock Bolt must be fastened only when the Dish Antenna Base is in 0 deg Position

**Notes:**

- At any time, keep **Elevation Adjustment Bolt in parallel to the pole.**
- Adjustment Bolts must be greased at all time.
- After fine adjustment use tightening torque of 4 Nm on Azimuth Lock Bolts (4PL) and 9 Nm on Nut of Elevation Lock Bolts (2PL).
- Tool required 1/2" open end or deep socket wrench.

SHEET 1 OF 1



## 2.8 Connecting the Cables

The following Figure shows the ODU interfaces. There are two active Ethernet interfaces (Eth1/Eth2). These may be optical (Fiber SFP) or electrical (RJ45) physical interfaces (configurable).

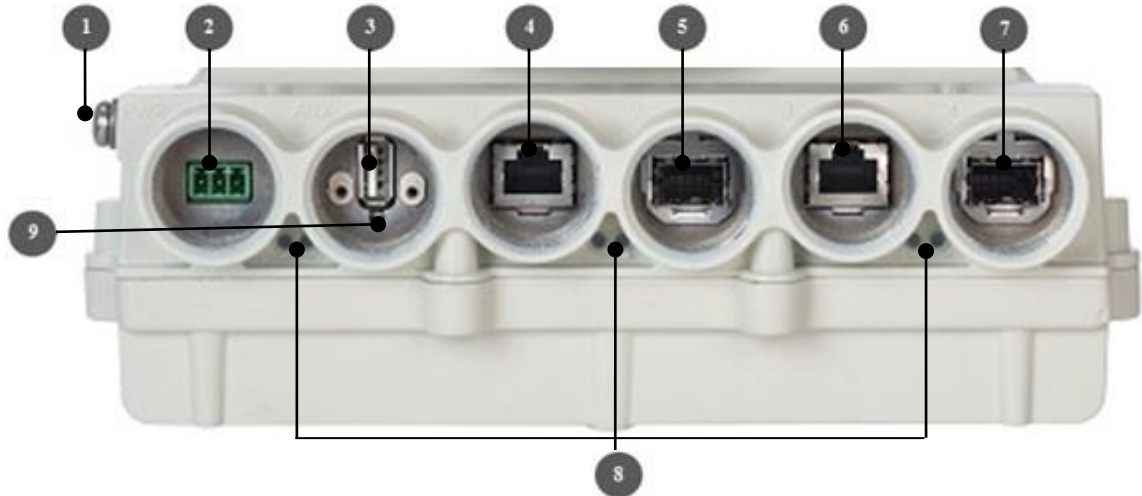

- |                                    |   |
|------------------------------------|---|
| 1. Electrical Ground Outlet (GND)  | 6. Ethernet Cable RJ45 Interface  |
| 2. Power Connector Interface (PWR) | 7. Fiber Cable SFP Interface (Eth4)   |
| 3. DVM Probe Interface (AUX)       | 8. System LEDs  |
| 4. Ethernet Cable RJ45 Interface   | 9. Reset Button (press for more than 8 seconds to restore factory defaults) |
| 5. Fiber Cable SFP Interface       |   |

Figure 2-5 EtherHaul Connection Panel Details

### 2.8.1 Power Options

To power up the EtherHaul using PoE, connect the cable to Eth#1.

DC connector – connect ONLY the (-) and (+):

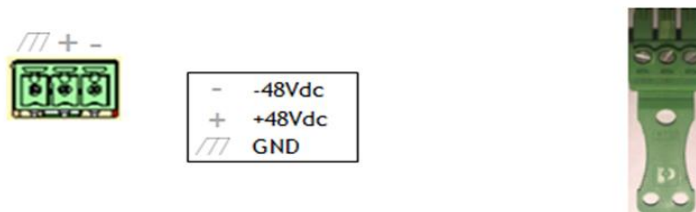

Figure 2-6 DC Connector

## 2.8.2 DC Power Supply Notes

The DC power input range of the ODU is 21 - 57 VDC.

- The DC supply should be limited to two ampere to avoid surges and possible damage to the ODU. For that, use limited power supply or circuit breaker (fast-blow fuse). The circuit-breaker is the disconnecting device, and should be readily accessible.
- When connecting the ODU to a MAINS DC distribution system, use a two ampere circuit breaker to enable the central DC system to isolate the ODU in an emergency case.
- Use one poly circuit breaker and should connect it on the live voltage: (+) or (-). The other poly should be grounded.
- Connect the circuit breaker to the (+) or (-) live voltage.
- The DC input is floating, so either (+) or (-) can be connected to the GND on the power supply side. For the sake of consistency with other systems, Siklu recommends that you connect the (+) to the GND.
- Use a two-wire cable (14-18 AWG) to connect the power supply to the ODU. On the ODU DC terminal, connect only the (+) and (-) wires. Do not connect to the ODU's GND input.

**Caution:**



**Disconnect all power cables before service!**

### 2.8.3 Grounding the EtherHaul

1. Connect one end of the grounding cable to the ground outlet on the left side of the ODU using the grounding cable lug.
2. Tighten the lug securely in place.
3. Connect the opposite end of the grounding cable to the earth connection, typically located on the mounting pole. If the earth connection is out of reach of the grounding cable, install an alternative cable.

To make a protective earth connection, use the grounding point located on the System ODU using a minimum amount of 16AWG grounding cable or according to local electrical code.

It is recommended to use Lightning Surge Protector on every Ethernet cable to protect the indoor networking equipment. The Lightning Surge Arrestor should be installed indoor next to the cable's point-of-entry and should be properly grounded.

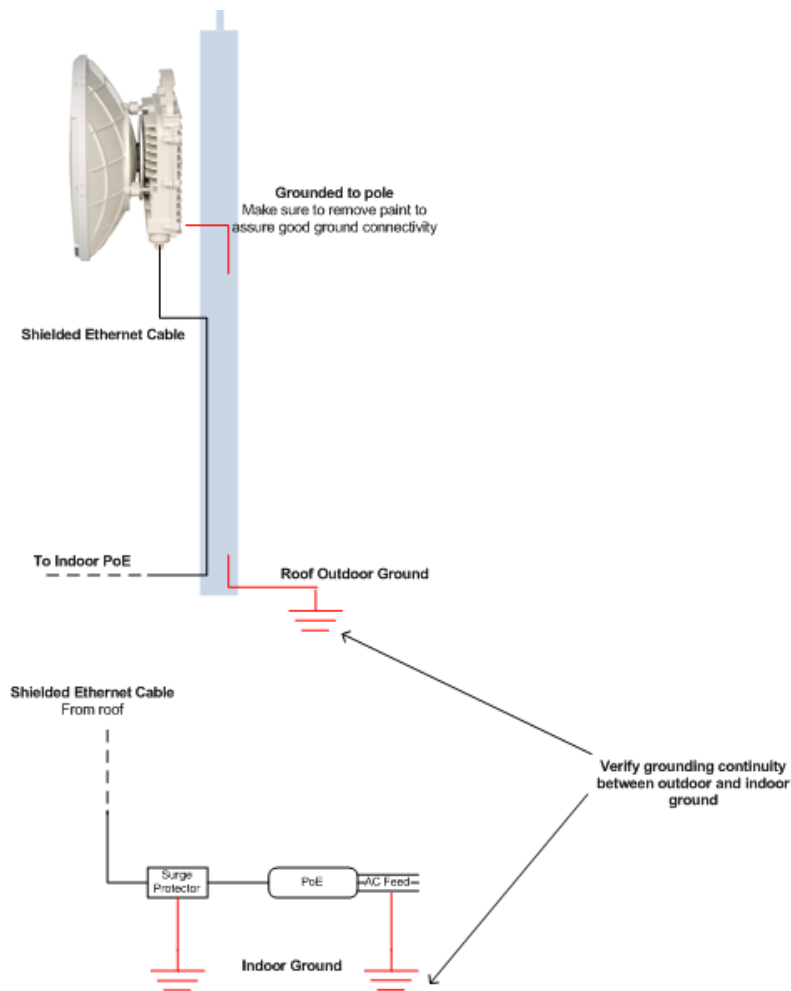
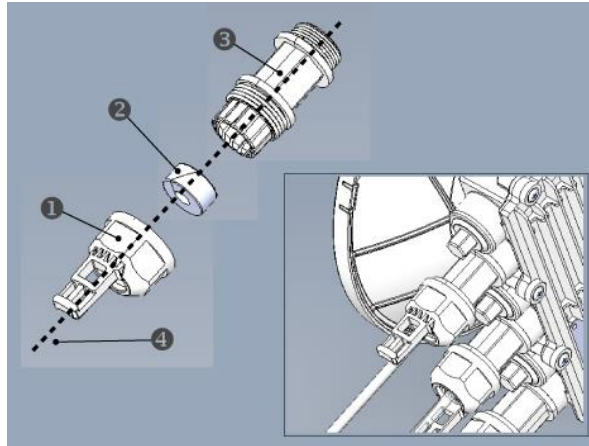

Figure 2-7 Grounding Scheme

## 2.8.4 Preparing the Cables

Before inserting a cable connector into the ODU, you must first enclose the cable connector in a protective All-Weather shell. Three sets of All-Weather shells are provided with the ODU for the ODU interfaces.



1. Cable Inlet Portion  
2. Rubber Gasket Insert

3. Connector Outlet Portion  
4. Ethernet Cable

*Figure 2-8 All-Weather Connecting Cable Shell Assembly*

Three sets of rubber gasket inserts are provided for different cable diameters:

- 4.2mm inner diameter – for cable diameter 3.5-4.9mm
- 5.8mm inner diameter – for cable diameter 5.0-6.7mm
- 7.9mm inner diameter – for cable diameter 6.8-9.0mm

For each ODU cable connection, perform the following procedure:

1. Disassemble a protective shell by unscrewing its parts and carefully removing the rubber gasket insert (❷) from the cable inlet portion (❶) of the shell.
2. Thread the cable connector through the cable inlet portion (❶) of the shell, through the rubber gasket insert (❷) and through the connector outlet portion (❸).
3. Connect the cable connector to the ODU interface.
4. Screw the connector outlet portion (❸) to the ODU firmly by hand (do not use tools).
5. Insert the rubber gasket insert snugly into the connector outlet portion (❸) of the shell.
6. Screw the cable inlet portion (❶) to the connector outlet portion (❸) firmly by hand (do not use tools).

## 2.8.5 Removing Connectors from the EtherHaul ODU

**Caution:**



To avoid accidental damage to the connector, always use the following order to remove cable connections from the ODU.

1. Unscrew the cable inlet portion (❶) of the All-Weather shell to release the gasket seal and then remove tension from the cable connector.
2. Unscrew the connector outlet portion (❸) of the All-Weather shell from its ODU port.
3. Remove the cable connector from its port.

## 2.8.6 Connecting DC Power

1. Carefully screw the connector outlet portion (❸) of the All-Weather shell into the PWR port. Tighten the connector outlet portion securely by hand (do not use tools).
2. Insert the power connector into the port. The PWR LED color indicator turns red for one second, then blinks green indicating that the ODU is powered on.
3. Screw the cable inlet portion (❶) of the All-Weather shell onto the secured connector outlet portion, taking care not to twist the connecting cable. Tighten the cable inlet portion securely by hand. The rubber gasket insert (❷) will tighten to create a moisture-proof seal (do not use tools).
4. Secure the power supply cable into place using a cable tie. Ensure that there is sufficient play in the cabling to allow movement of the ODU during final alignment.
5. Wait for the EtherHaul ODU to boot up (about two minutes). When the ODU is fully rebooted, the PWR LED color indicator turns green (during power-up the PWR LED blinks green) and the RF LED color indicator turns off, indicating that the link is down.

## 2.8.7 Connecting Other Interfaces

For each network connection, perform the following steps:

6. Carefully screw the connector outlet portion (❸) of the All-Weather shell into the appropriate port. Tighten the connector outlet portion securely by hand (do not use tools).
2. Insert the RJ45 or SFP connector into the port.
7. Screw the cable inlet portion (❶) of the All-Weather shell onto the secured top portion, taking care not to twist the connecting cable.
8. Tighten the bottom portion securely by hand. The rubber gasket insert (❷) tightens to create a moisture-proof seal (do not use tools).

9. Secure the network connection cable into place using a cable tie. Ensure that there is sufficient play in the cabling to allow movement of the ODU during final alignment.

## 2.9 System LEDs

LED	Color	Description
PWR (Power)	Green – Power OK	Blink Green – Device boot
	Red – Power Failure	
	Off – No Power	
RF	Green – Link Up	Blink Green – Device boot
	Orange – Alignment Mode	
	Off – Link Down	
ETH1/2:	Green – Link 1G	Blink Green – 1G activity
	Orange – Link 10/100	Blink Orange – 10/100 activity
	Off – No Link (Carrier)	

## 2.10 Aligning the Antenna

The ODU antenna must be aligned on both local and remote ODUs. You must first perform coarse alignment on each ODU, followed by fine alignment. Accurate alignment of the ODU is critical for achieving the strongest possible receive signal.

To perform antenna alignment, the ODU must be in Alignment mode.

The ODU has three modes of operation:

- **Alignment** – Carrier Wave transmission. Used for antenna alignment.
- **Adaptive** – Operational mode used with adaptive bandwidth, code, and modulation.
- **Static** – Operational mode used with a fixed modulation profile.

ODUs are shipped from the factory in Adaptive mode.

The ODU antenna must be aligned on both local and remote ODUs. You must first perform coarse alignment on each ODU, followed by fine alignment. Accurate alignment of the ODU is critical for achieving the strongest possible receive signal.

To perform antenna alignment, the ODU must be in Alignment mode.

The ODU has three modes of operation:

- **Alignment** – Carrier Wave transmission. Used for antenna alignment.
- **Adaptive** – Operational mode used with adaptive bandwidth, code, and modulation.
- **Static** – Operational mode used with a fixed modulation profile.

ODUs are shipped from the factory in Adaptive mode.

## 2.10.1 Setting the ODU to Alignment Mode

Switch the EtherHaul ODUs to Alignment mode by inserting the DVM probes into the AUX Interface sockets. The RF LED color indicator turns orange, indicating the ODU is in Alignment mode.

The ODU remains in Alignment mode even if the DVM probes are ejected, until the ODU is rebooted.

## 2.10.2 Performing the Alignment

 **Note:** These instructions are for aligning a one-foot antenna. For instructions on aligning a two-foot antenna, refer to *Installing the ODU with a Two Foot Antenna*.  
These instructions refer to *Figure 2-1 EtherHaul Mounting Assembly Components*.

### To perform an alignment

1. Verify that the ODU is in Alignment Mode.

### Coarse Alignment (Azimuth Only)

2. Loosen the unit mounting bolts (ⓘ) slightly to allow the ODU some freedom of movement.
3. Perform a coarse ODU alignment using a line-of-sight visual check with the remote EtherHaul ODU. Lock the unit mounting bolts (ⓘ) using the 13mm open wrench.
4. Repeat steps 1 to 3 above on the remote ODU.

### Fine Alignment

 **Note:** When aligning an antenna, the antenna in the remote node must remain completely stationary. Perform Fine alignment first on the local antenna, and only afterwards on the remote antenna.  
The optimum alignment may require several adjustment iterations between the local and remote antennas.

5. Connect the DVM to the ODU by inserting both red and black probes into their appropriate positions in the AUX port.

Throughout the alignment procedure, you must compare the actual receive signal strength indication (RSSI) to the expected RSSI that was calculated during network link budget preparation (refer to *Preparing for Installation* on page 20).

Read the receive level (RSSI) using the DVM. The voltage reading will be between 0 to 1V, indicating the RSSI in dBms. For example, a DVM reading of 0.45V is equivalent to -45 dBm.

6. Align the fine Azimuth axis. Use the hexagonal wrench to adjust the Azimuth fine adjustment screw (⑨). Be sure to sweep the complete range of the Azimuth in order to determine the maximum received signal strength position.

When the optimum axis is achieved, tighten both Azimuth adjustment lock bolts (⑥).

7. Align the fine elevation axis. Use the hexagonal wrench to adjust the elevation fine adjustment screw (⑩). Be sure to sweep the complete range of the elevation in order to determine the maximum received signal strength position.

When the optimum axis is achieved, tighten both elevation adjustment lock bolts (⑦).

8. Perform steps 6 and 7 for the remote ODU.
9. Repeat steps 6 and 7 for the local ODU.
10. Use the DVM to verify maximum received signal strength on both local and remote ODUs. For best performance, measured RSSI should be within  $\pm 4$  dB of the calculated value.
11. Once the optimum position has been achieved for the ODU pair, tighten the Azimuth adjustment lock bolts (⑥) on one ODU (torque of 8 nM), being very careful not to move the ODU while tightening.
12. Tightening the Azimuth adjustment lock bolts will tilt the ODU, so realign the elevation again for optimum position.
13. Once the optimum position has been achieved for the ODU pair, tighten the elevation adjustment lock bolts (⑦) on the ODU (torque of 8 nM), being very careful not to move the ODU when tightening.
14. Repeat steps 11 through 13 for the second ODU.
15. Use the DVM to verify that the received signal strength has not changed on either the local or the remote ODU after final tightening of the brackets.

Antenna alignment is now complete.

## 2.11 Link Up Verification

1. Disconnect the DVM probes.
2. Reboot both ODUs by shortly pressing the ODU Reset Button or alternatively disconnect/reconnect the power.
3. This action will return the ODU to Adaptive Mode (ODU's default operational mode). Following this action, and after the ODU has finished rebooting, the RF



LED color indicator on both ODUs will turn Green, indicating that the radio link is up.

The EtherHaul link can now pass traffic and management between the ports and over the radio link.

Use the Web-based management or Command Line Interface for radio link configuration and monitoring.

### **3 Performing Basic Setup Using the Web-Based Management**

This chapter describes how to perform basic setup using the web-based management.

The scope of this installation manual is basic setup and monitoring of the radio link.

- For full configuration and maintenance procedures, refer to the “EtherHaul Operation, Administration and Maintenance Manual”.
- The “EtherHaul Operation, Administration and Maintenance Manual” also details the configuration, monitoring and maintenance procedures using the Command Line Interface.

This chapter includes the following topics:

- Connecting to the ODU using the Web-Based Management
- Main Page
- General Configuration Commands
- Quick Configuration Wizard
- Radio Page
- Default Bridge Configuration
- Applying and Saving Configuration Changes

### 3.1 Connecting to the ODU Using the Web-Based Management

1. Launch an Internet Browser and enter `https://` followed by the ODU's IP address. The ODU's default IP address is `192.168.0.1`.

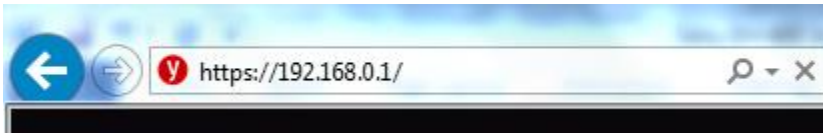

Figure 3-1 Launching the Web-Based Management

2. When prompted, enter the username and password. Default: **admin** and **admin**.



Figure 3-2 Entering Username and Password

3. Once loaded, the Web-Based Management Main page is displayed.

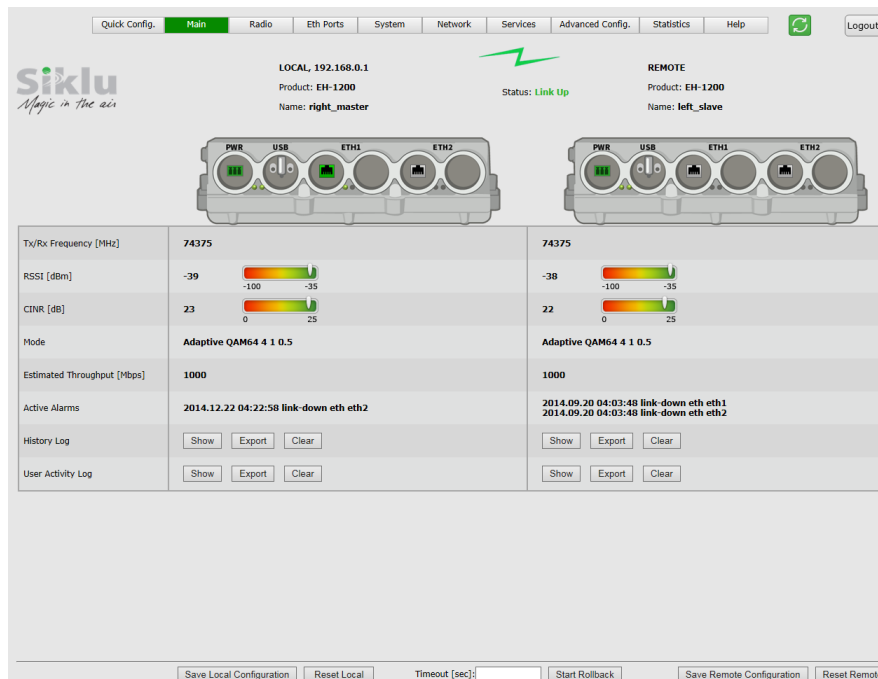

Figure 3-3 Web-Based Management Main Page

## 3.2 Main Page

The Web-Based Management provides link view, presenting both local and remote configuration and monitoring.

Although the local and remote systems IP address is identical (default IP address 192.168.0.1), the remote will be available as well as the EtherHaul uses dedicated communication channel for local-remote communication that is not IP-based.

It is recommended, however, to assign dedicated IP address for local and remote systems.

**Note:** Depending on your station's screen size and resolution, you may need to scroll the screen vertically or horizontally in order to view all options for local + remote.



Alternatively, you may change the change the Internet's Browser display distance (Zoom out, using Ctrl+Minus).

The Web-Based Management Main page is a read-only page and displays the following information:

- Link Status – Link up or down (with visual indication)
- Link Length [m] – link calculated distance between the local and remote systems (air distance) based on propagation time.
- Tx/Rx frequency [MHz]
- RSSI [dBm] – Receiver Signal Strength Indicator. Current receive level.
- CINR [dB] – Carrier to Interference + Noise ratio. Indicates the current radio link's signal quality. In normal conditions,  $CINR \geq 19$  indicates a good signal quality.
- Mode – Current operational mode of the link:
  - Alignment – Carrier Wave transmission. Used for antenna alignment. No data over the radio link.
  - Static – Fixed modulation profile. If you select Static, you must select from a list of pre-configured modulation profiles in the Modulation field.
  - Adaptive – Adaptive Bandwidth, Code, and Modulation. The system will work on the highest modulation profile based on the CINR values of the both sides and will present the current modulation profile.
- Estimated Throughput [Mbps] – based on the current modulation profile.
  - For FDD systems – value is Full-Duplex.
  - For TDD systems – value is aggregated (Half-Duplex).

**Note:**



Actual Layer 1 throughput depends on product's specs. Refer to the EtherHaul Release Notes for exact specifications.

- Current Alarms – list of currently active alarms and date&time raised.
- History Log – System alarms and events history log.
- User Activity Log – All configuration changes are logged, including user and date&time (presented in the form of CLI commands).

**Note:**



To view logs, pop-ups must be enabled and allowed on your Internet Browser.

## 3.3 General Configuration Commands

### 3.3.1 Apply

Any configuration change is executed upon clicking **Apply**.

The Local-Remote concept of the Web-Based Management allows configuring both local and remote systems of the link.

The **Apply** button is available at the bottom of each configuration page (one button for both local and remote systems).

When clicking **Apply**, the configuration changes will be sent to remote system first and then to the local system. If multiple parameters changed on the page before clicking **Apply**, all parameters are sent in bulk to the system and then executed locally in order to avoid losing management connection.

### 3.3.2 Save Configuration

Any configuration change applied should be saved using the **Save Configuration** button.

The system has two configuration banks:

1. Running Configuration – the currently active configuration. Every time **Apply** is clicked, the Running Configuration is updated.
2. Startup Configuration – the configuration the system will come up with after the next reset. This configuration may be different than the currently active configuration (Running Configuration).

In order to save the applied configuration changes, click **Save Configuration** so changes will be saved to the startup configuration. If changes are not saved to the startup configuration, they will be lost the next time the system resets.

**Save Configuration** buttons are available for local and remote systems.

### 3.3.3 Rollback

A safety measure that allows recovering from system configuration changes that caused loss of communication.

When Rollback is used, a timer runs (and restarts) whenever a management (or CLI) command is entered. In the event that no command is entered within the timeout period, the system automatically resets and comes up with the saved startup configuration.

A Rollback timeout is especially recommended when configuring remote elements that are being managed over the link.

Rollback is activated for both local and remote systems.

### 3.3.4 Reset

Separate buttons for local and remote reset. The system will reset and come up after initialization (~120 seconds).

Note that any unsaved changes will be lost.

### 3.3.5 Copy To Remote

You can find the **Copy To Remote** button next to some configuration parameters or sections. This function copies configuration to remote system based on the changes on the local system.

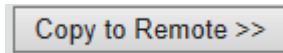

*Figure 3-4 Copy To-Remote icon*

Matching configuration may be of two types:

- Identical configuration – exactly same configuration will be copied from the local to remote system. It can be found for parameters that normally requires identical configuration for both local and remote units.  
For example, Encryption configuration.
- Matching configuration – for parameters that require matching but opposite configuration.

### 3.4 Quick Configuration Wizard

Use the Quick Configuration wizard to configure the basic system parameters. It holds the basic minimal configuration required to start using the link.

The Quick Configuration wizard should be used for the initial system setup after installation. For monitoring and advanced configuration, please refer to the dedicated configuration pages of the Web-Based Management.

To access the Quick Configuration wizard, go to the **Quick Config** page.

#### 3.4.1 Quick Configuration: Step 1 – System

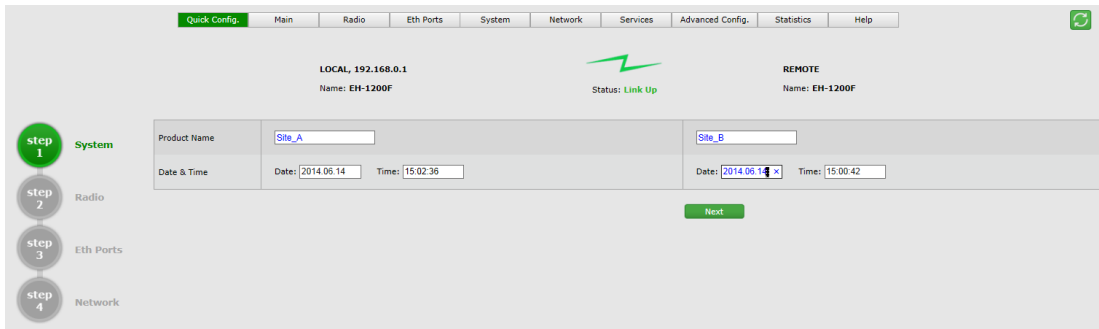

Figure 3-5 Quick Config Page: Step 1 - System

The first section allows configuring the following parameters:

- Name – you can give a name for each system
- Date – [YYYY.MM.DD]
- Time – [HH:MM:SS]

Click **Next** to continue.

#### 3.4.2 Quick Configuration: Step 2 – Radio

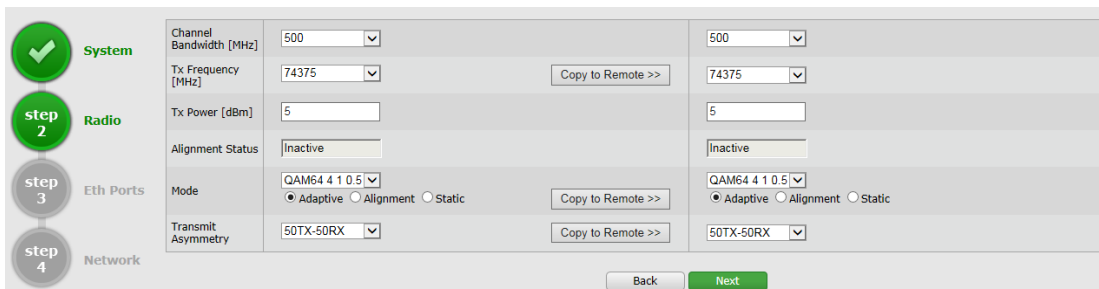



Figure 3-6 Quick Config Page: Step 2 - Radio



This section allows configuring the following parameters:

- Channel Bandwidth [MHz] – 250 or 500MHz (default is 500MHz).  
Note: 250MHz support depends on product's specs.
- Tx Frequency [MHz] – transmit frequency.
- Rx Frequency [MHz] – R/O field, updated based on Tx frequency.
- Tx Power [dBm] – ODU's transmit power. Default is the max power, based on product's specs. Minimum configurable Tx power is -35dBm (note that actual minimum Tx power is based on product's specs).

**Note:**  Adjust Tx Power so the RSSI at the remote end will not exceed -35dBm (overload threshold).

The Tx power value sets the transmit power for the highest modulation profile. In case lower modulation profile(s) has higher max Tx power (based on product's specs), the Tx power will be increased automatically without indication in RF configuration menu.

- Mode – operational mode of the link:
  - Alignment – Carrier Wave transmission. Used for antenna alignment. No data over the radio link.

**Note:**  When exiting Alignment mode, perform system reset to allow proper operation of the radio link.

- Static – Fixed modulation profile. If you select Static, you must select from a list of pre-configured modulation profiles in the Modulation field.
- Adaptive – Adaptive Bandwidth, Code, and Modulation.  
The ODU will work on the highest modulation profile based on the CINR values of the both sides and will present the current modulation profile.  
Adaptive mode is the normal and recommended mode of the radio link.
- Alignment Status – R/O field, indicating that the ODU is currently in Alignment mode (by configuration or by inserting DVM probes).
- Transmit Asymmetry – Default value is symmetric configuration: 50% for Tx and Rx (50tx-50rx). For an asymmetric configuration (75%/25% or 90%/10%), Role

has to be set: the Master unit transmits the higher rate (75tx-25rx or 90tx-10rx) and the Slave unit the lower rate (25tx-75rx or 10tx-90rx).

When selecting asymmetric configuration, Role will be set automatically (refer to Radio Advanced Settings).

Click **Next** to continue or **Back** to return to previous section.

### 3.4.3 Quick Configuration: Step 3 – Eth Ports

	Eth1	Eth2	Eth1	Eth2
Port Type	<input checked="" type="radio"/> RJ45 <input type="radio"/> SFP	<input checked="" type="radio"/> RJ45 <input type="radio"/> SFP	<input checked="" type="radio"/> RJ45 <input type="radio"/> SFP	<input checked="" type="radio"/> RJ45 <input type="radio"/> SFP
Port Enable	<input checked="" type="checkbox"/>	<input checked="" type="checkbox"/>	<input checked="" type="checkbox"/>	<input checked="" type="checkbox"/>
Auto-Negotiation	<input checked="" type="checkbox"/>	<input checked="" type="checkbox"/>	<input checked="" type="checkbox"/>	<input checked="" type="checkbox"/>
Speed/Duplex	1000FD			

Figure 3-7 Quick Config Page: Step 3 – Eth Ports

This section allows configuring the following parameters:

- Port status visual display (Green – port is up).
- Port Type – RJ45 or SFP (configurable)
- Port Enable – checkbox to enable the port.
- Auto Negotiation – checkbox to enable auto-neg.
- Speed/Duplex – speed (10/100 or 1000) and duplex (half/full) setting:
  - When Auto Negotiation Enabled – R/O field indicating the current speed/duplex
  - When Auto Negotiation Disabled – allows configuring the speed/duplex.
  - R/O field indicating the current speed/duplex (note that for SFP ports, only 1000 speed is available).

Click **Next** to continue or **Back** to return to previous section.

### 3.4.4 Quick Configuration: Step 4 – Network

The screenshot shows the 'Quick Config' page for Step 4 – Network. The page is divided into several sections:

- System:** LOCAL, 192.168.0.1, Name: EH-1200F. REMOTE: Name: EH-1200F. Status: Link Up.
- IP Address:** Two columns for LOCAL and REMOTE configurations. Each column has a table with columns: #, Type, IP Address, Prefix-length, and VLAN.
 

#	Type	IP Address	Prefix-length	VLAN
1	Static	192.168.0.1	24	0
2	Static	10.10.10.1	24	0
- Default Gateway:** Fields for IP Address (10.10.10.250) and IPv6 Address.
- SNMP Managers:** A table with columns: #, IP Address, UDP-Port, Security Name, SNMP Ver, and Engin ID.

Figure 3-8 Quick Config Page: Step 4 – Network

This section allows configuring the following parameters:

- IP Address

The EtherHaul supports up to four IP addresses that can be associated with different VLANs. IPv4 or IPv6 can be configured. IP addresses may also be acquired by DHCP.

- # - Index (1-4)
- Type – Static or DHCP
- IP Address – Default is 192.168.0.1
- IP Prefix Length – Default is 24 (equivalent to Mask of 255.255.255.0)
- VLAN – 0 (not defined, meaning the IP is not associated with specific VLAN)

Click the Trash icon to clear an IP. Note you cannot clear the IP address you used to log in to the system.

- Default Gateway
- SNMP Managers

Up to five managers that will receive SNMP traps can be configured (SNMPv2c or SNMPv3).

- # - Index (1-5)
- IP Address – Destination IP Address
- UDP Port – port number for sending traps

- Security Name (community)
- SNMP Ver – SNMP version (SNMPv2c or SNMPv3)
- Engine ID – Used for SNMPv3

Click **Apply** to execute the configuration changes or **Back** to return to previous section.

### 3.5 Radio Page

The radio link parameters and radio link monitoring are managed in the **Radio** page.

This chapter includes the following topics:

- Settings
- Advanced Settings
- Maintenance
- Modulation Table
- Statistics

#### 3.5.1 Settings

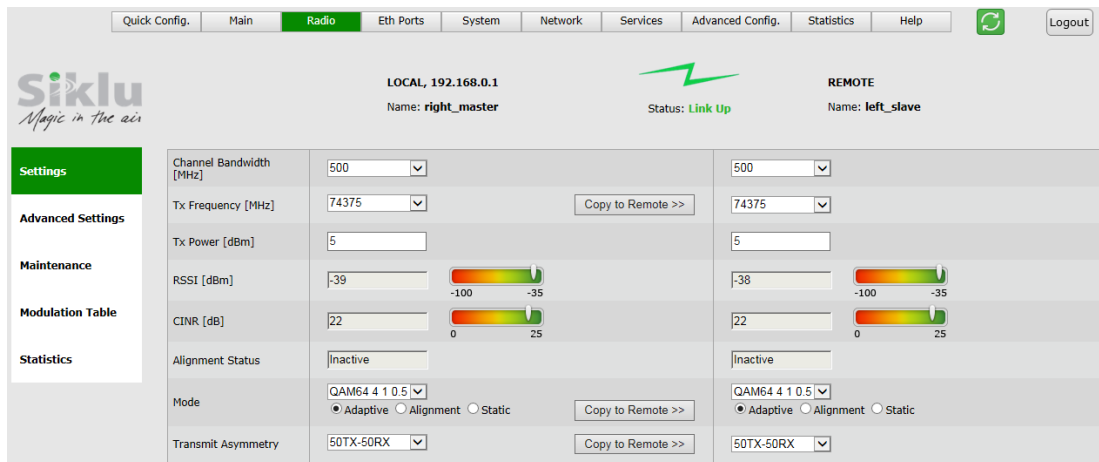

Figure 3-9 Radio Page: Settings

This section allows configuring the following parameters:

- Channel Bandwidth [MHz] –500MHz.
- Tx Frequency [MHz] – transmit frequency.
- Rx Frequency [MHz] – R/O field, updated based on Tx frequency.
  - For TDD systems – identical Tx and Rx frequencies.

- Tx Power [dBm] – ODU's transmit power. Default is the max power, based on product's specs. Minimum configurable Tx power is -35dBm (note that actual minimum Tx power is based on product's specs).

**Note:**



Adjust Tx Power so the RSSI at the remote end will not exceed -35dBm (overload threshold).

The Tx power value sets the transmit power for the highest modulation profile. In case lower modulation profile(s) has higher max Tx power (based on product's specs), the Tx power will be increased automatically without indication in RF configuration menu.

- Mode – operational mode of the link:
  - Alignment – Carrier Wave transmission. Used for antenna alignment. No data over the radio link.

**Note:**



When exiting Alignment mode, perform system reset to allow proper operation of the radio link.

- Static – Fixed modulation profile. If you select Static, you must select from a list of pre-configured modulation profiles in the Modulation field.
- Adaptive – Adaptive Bandwidth, Code, and Modulation.

The ODU will work on the highest modulation profile based on the CINR values of the both sides and will present the current modulation profile.

Adaptive mode is the normal and recommended mode of the radio link.

- Alignment Status – R/O field, indicating that the ODU is currently in Alignment mode (by configuration or by inserting DVM probes).
- Transmit Asymmetry – Default value is symmetric configuration: 50% for Tx and Rx (50tx-50rx). For an asymmetric configuration (75%/25% or 90%/10%), Role has to be set: the Master unit transmits the higher rate (75tx-25rx or 90tx-10rx) and the Slave unit the lower rate (25tx-75rx or 10tx-90rx).

When selecting asymmetric configuration, Role will be set automatically (refer to Radio Advanced Settings).

### 3.5.2 Advanced Settings

<b>Settings</b> <b>Advanced Settings</b> <b>Maintenance</b> <b>Modulation Table</b> <b>Statistics</b>	Long Range Mode	Normal	Normal
	Encryption	<input type="checkbox"/> Static-key: 92E3C28020570998E74B41C06A58BB40 <input type="button" value="Copy to Remote &gt;&gt;"/>	<input type="checkbox"/> Static-key: 92E3C28020570998E74B41C06A58BB40
	Role	Auto	Auto
	Link ID	Tx : 0 Rx : 0	Tx : 0 Rx : 0
	Automatic Repeat Request	<input checked="" type="checkbox"/> Status: Established	<input checked="" type="checkbox"/> Status: Established
	Lowest Modulation	QPSK 1 4 0.5	QPSK 1 4 0.5

Figure 3-10 Radio Page: Advanced Settings

This section allows configuring the following parameters:

- Long Range Mode – checkbox to enable extended range mode (feature is license dependant):
  - Normal – links from 0 to 5Km
  - Long – links from 5 to 10Km
  - Extra-Long – links from 10 to 15Km
- Encryption – checkbox to enable Encryption and field to enter the static key.

The EtherHaul supports 128bit and 256bit AES encryption with Static key. This means that the encryption key (32 characters long for AES 128bit or 64 characters long for AES 256bit) must be inserted manually into both ends of the link. If there is an encryption mismatch, traffic does not go over the link.

Encryption is a licensed feature that requires license for operation. Before configuring it, verify that license is available and enable the **encryption** license component.

- Role – Determines whether the ODU functions as a master or slave. In a link, one side must be set to Master and the other side must be set to Slave (required for link synchronization). Default value is Auto, meaning the role is set automatically by the link.

Manually setting the Role is necessary only for asymmetric configurations.

- Transmit Asymmetry – Default value is symmetric configuration: 50% for Tx and Rx (50tx-50rx). For an asymmetric configuration (75%/25% or 90%/10%), Role has to be set: the Master unit transmits the higher rate (75tx-25rx or 90tx-10rx) and the Slave unit the lower rate (25tx-75rx or 10tx-90rx).
- Link ID – unique Tx and Rx Link IDs for links installed on the same site to avoid locking on the wrong transmitter.

Link IDs must be identical on both ends for the link to be operational.

- ARQ - checkbox to enable the mode and field to view the current status.

The ARQ (Automatic Repeat Request) is an algorithm that uses selective repeat (retransmission) to eliminate radio BER. The default mode is **Enabled**. When both sides are enabled and radio link is up, ARQ status will be **Established**.

Disabling the ARQ mode is not recommended as it may result in radio BER.

- **Lowest Modulation** – Lowest modulation profile. When modulation drops below this threshold, radio link will be down. It is used to limit the minimal modulation profile of the link. Default is QPSK 1 4 0.5 (lowest available).

### 3.5.3 Maintenance

Figure 3-11 Radio Page: Maintenance

This section allows configuring the following parameters:

- **RF Loopback** – checkbox to enable the internal RF loopback, set the timeout for clearing the loopback in seconds and select the modulation the ODU will be tested at.

Note that it will take the ODU to stabilize after loopback up to 3 minutes so set the loopback timeout accordingly (recommended 600 seconds).

Mute remote transmitter first to avoid interference with the loopback operation.

Loopback is done with MAC addresses swap.

Refer to the *Diagnostics* chapter of the *EtherHaul Operation, Administration and Maintenance Manual* for detailed description of the system's loopbacks.

- **Mute** – checkbox to mute the transmitter with timeout in seconds. When muted, the ODU will not transmit.

### 3.5.4 Modulation Table

Frequency	Modulation	Subchannels	Repetitions	FEC Rate	CINR Low
Any	QPSK	1	4	0.5	-128
Any	QPSK	2	2	0.5	6
Any	QPSK	4	1	0.5	9
Any	QAM16	4	1	0.5	13
73875	QPSK	1	4	0.5	-128
73875	QPSK	2	2	0.5	6
73875	QPSK	4	1	0.5	7
73875	QAM16	4	1	0.5	13
73875	QAM64	4	1	0.5	16
74375	QPSK	1	4	0.5	-128
74375	QPSK	2	2	0.5	6
74375	QPSK	4	1	0.5	7
74375	QAM16	4	1	0.5	13
74375	QAM64	4	1	0.5	16
74875	QPSK	1	4	0.5	-128
74875	QPSK	2	2	0.5	6
74875	QPSK	4	1	0.5	7
74875	QAM16	4	1	0.5	13
74875	QAM64	4	1	0.5	16
75375	QPSK	1	4	0.5	-128
75375	QPSK	2	2	0.5	6
75375	QPSK	4	1	0.5	7
75375	QAM16	4	1	0.5	13
75375	QAM64	4	1	0.5	16

Figure 3-12 Radio Page: Modulation Table

The modulation table presents the available modulation profiles. The radio can be configured only to one of the profiles available in the table.

- CINR Low – Lower threshold for stepping down in modulation profile (Adaptive Mode).
- CINR High – Upper threshold for stepping up in modulation profile (Adaptive Mode).

Note that different modulation tables may apply according to product used, the frequency channel used and ARQ status.

The modulation profiles and thresholds are optimized and should not be modified (can be configured via CLI only after consulting Siklu support).

### 3.5.5 Statistics

Radio link's performance can be monitored using the advanced statistics counters.

Refer to the *Statistics* chapter of the *EtherHaul Operation, Administration and Maintenance Manual* for detailed description of the system's statistics.



## **3.6 Default Bridge Configuration**

The default system's configuration is IEEE 802.1d Transparent Bridge. In this mode, all traffic (both tagged and untagged) is transparently forwarded between all ports and over the radio.

## 4 Commissioning and Acceptance Procedure

This chapter presents the recommended commissioning and acceptance procedure to be performed following the installation of each EtherHaul radio link.

The commissioning and acceptance procedure verifies the correct installation and the proper, safe, and robust operation of the EtherHaul RF link.

This chapter includes the following topics:

- 
- Installation Verification and Testing
- EtherHaul Commissioning and Acceptance Form

### 4.1 Installation Verification and Testing

Inspect the following components and confirm their adherence to requirements that are detailed in the accompanying checklist.

#### 4.1.1 Physical Installation Verification

This inspection verifies the physical installation of the ODU, in accordance with the EtherHaul's installation procedure and requirements.

1. Pole mount installation
2. ODU installation
3. Weatherproofing the cables
4. Cables installation
5. Grounding

#### 4.1.2 RF Link Test

This inspection verifies the RF link status.

1. RF LED is green.
2. Management/CLI indication: "RF Operational – Up".
3. Receive Signal Strength Indication (RSSI) achieved in Alignment mode is within +/-4dB of the expected value.
4. Carrier to Interference + Noise Ratio (CINR) is 19 or higher.
5. Highest modulation achieved
6. Link configuration is in accordance with plan requirements.

#### 4.1.3 Link Errors Test

This inspection verifies frame-loss-free operation of the radio link.

1. No ARQ losses on the RF Statistics counters.

#### 4.1.4 Ethernet Services Test

This inspection verifies correct Ethernet services flow and error-free operation.

1. Connect PCs on both ends of the link and use software-based utilities to test for packet-loss.
2. If available, connect a packet analyzer to the GbE port and verify that no packets are lost.

#### 4.1.5 Management Verification

This inspection verifies proper management of the link.

1. Verify correct management/CLI connection to both local and remote ODUs.
2. Verify management access from remote NMS stations.

#### 4.1.6 Recording ODU Configuration

Perform the following steps after the EtherHaul ODU is commissioned and accepted:

1. Copy the Running Configuration (currently active) to Startup Configuration.
2. Save the configuration file for future records and backup.

## 4.2 EtherHaul Commissioning and Acceptance Form

EtherHaul™ Commissioning and Acceptance Form		
<b>Customer Details</b>		
Customer		
Project/link name		
<b>Physical Installation Verification</b>	<u>Local Site</u>	<u>Remote Site</u>
Site name & address		
Mount type	<input type="checkbox"/> Roof-top <input type="checkbox"/> Mast/Tower <input type="checkbox"/> Other _____	<input type="checkbox"/> Roof-top <input type="checkbox"/> Mast/Tower <input type="checkbox"/> Other _____

ODU mount above ground	Meters	meters
Clear line-of-sight	<input type="checkbox"/> Yes <input type="checkbox"/> No _____	
ODU safely mounted using Siklu's bracket correctly installed	<input type="checkbox"/> Yes <input type="checkbox"/> No	<input type="checkbox"/> Yes <input type="checkbox"/> No
Pole diameter according to mount specs	<input type="checkbox"/> Yes <input type="checkbox"/> No	<input type="checkbox"/> Yes <input type="checkbox"/> No
Bracket's mounting bolts securely tightened	<input type="checkbox"/> Yes <input type="checkbox"/> No	<input type="checkbox"/> Yes <input type="checkbox"/> No
ODU grounding	<input type="checkbox"/> Yes <input type="checkbox"/> No	<input type="checkbox"/> Yes <input type="checkbox"/> No
Cables/Fibers connections (mark all cables connected)	<input type="checkbox"/> Eth1 Cat5 <input type="checkbox"/> Eth1 Fiber <input type="checkbox"/> Eth2 Cat5 <input type="checkbox"/> Eth2 Fiber <input type="checkbox"/> Eth3 Cat5 <input type="checkbox"/> Eth3 Fiber <input type="checkbox"/> Eth4 Cat5 <input type="checkbox"/> Eth4 Fiber <input type="checkbox"/> DC	<input type="checkbox"/> Eth1 Cat5 <input type="checkbox"/> Eth1 Fiber <input type="checkbox"/> Eth2 Cat5 <input type="checkbox"/> Eth2 Fiber <input type="checkbox"/> Eth3 Cat5 <input type="checkbox"/> Eth3 Fiber <input type="checkbox"/> Eth4 Cat5 <input type="checkbox"/> Eth4 Fiber <input type="checkbox"/> DC
Overall cables/fibers length	meters	meters
Cables/Fibers securely routed and fixed properly using cable ties	<input type="checkbox"/> Yes <input type="checkbox"/> No	<input type="checkbox"/> Yes <input type="checkbox"/> No
Cables/Fibers are properly weatherproofed using the appropriate glands	<input type="checkbox"/> Yes <input type="checkbox"/> No	<input type="checkbox"/> Yes <input type="checkbox"/> No
ODU DC source	<input type="checkbox"/> PoE <input type="checkbox"/> External DC	<input type="checkbox"/> PoE <input type="checkbox"/> External DC
PoE model and manufacturer		
Measured DC power (management reading)	Volts DC	Volts DC
<b>RF Link Parameters</b>		
ODU Model		
ODU P/N		
ODU S/N		

ODU running SW version		
Tx/Rx frequency	MHz	MHz
Channel-width	<input type="checkbox"/> 250MHz <input type="checkbox"/> 500MHz	<input type="checkbox"/> 250MHz <input type="checkbox"/> 500MHz
Role	<input type="checkbox"/> Auto <input type="checkbox"/> Master <input type="checkbox"/> Slave	<input type="checkbox"/> Auto <input type="checkbox"/> Master <input type="checkbox"/> Slave
Tx/Rx Link ID	0 (not used)	0 (not used)
Modulation/Mode <small>Mode: modulation/sub-channel/repetitions/FEC</small>	<input type="checkbox"/> Adaptive _____ <input type="checkbox"/> Static _____	<input type="checkbox"/> Adaptive _____ <input type="checkbox"/> Static _____
UL/DL Configuration	<input type="checkbox"/> Symmetric <input type="checkbox"/> Asymmetric (ratio)_____%	
ODU polarization	<input type="checkbox"/> V <input type="checkbox"/> H	<input type="checkbox"/> V <input type="checkbox"/> H
Long Range Mode	<input type="checkbox"/> Yes <input type="checkbox"/> No	<input type="checkbox"/> Yes <input type="checkbox"/> No
Link distance	meters	
<b>RF Link Tests</b>		
Expected RSSI	dBm	dBm
Measured RSSI	dBm	dBm
Measured CINR	dB	dB
Green "RF" LED	<input type="checkbox"/> Yes <input type="checkbox"/> No	<input type="checkbox"/> Yes <input type="checkbox"/> No
RF operational status Up	<input type="checkbox"/> Yes <input type="checkbox"/> No	<input type="checkbox"/> Yes <input type="checkbox"/> No
RF Statistics error counters clear	<input type="checkbox"/> Yes <input type="checkbox"/> No	<input type="checkbox"/> Yes <input type="checkbox"/> No
<b>Ethernet Services Tests</b>		
Frame-Loss test <input type="checkbox"/> Packet Analyzer <input type="checkbox"/> SW-based <input type="checkbox"/> EtherHaul Statistics	<input type="checkbox"/> No Frame-Loss Test duration _____	<input type="checkbox"/> No Frame-Loss Test duration _____
<b>Management</b>		

IP address	IP _____ VLAN _____	IP _____ VLAN _____
Prefix-Length / IP Mask		
Default IP Gateway		
Management of local and remote	<input type="checkbox"/> Yes <input type="checkbox"/> No	<input type="checkbox"/> Yes <input type="checkbox"/> No
NMS used	<input type="checkbox"/> _____	<input type="checkbox"/> _____
NMS management access	<input type="checkbox"/> OK <input type="checkbox"/> NOK <input type="checkbox"/> N/A	<input type="checkbox"/> OK <input type="checkbox"/> NOK <input type="checkbox"/> N/A
Traps received in NMS	<input type="checkbox"/> OK <input type="checkbox"/> NOK <input type="checkbox"/> N/A	<input type="checkbox"/> OK <input type="checkbox"/> NOK <input type="checkbox"/> N/A
<b>Final Configuration Verification</b>		
Copy running config to startup	<input type="checkbox"/> Done	<input type="checkbox"/> Done
Clear all statistics and logs	<input type="checkbox"/> Done	<input type="checkbox"/> Done
Configuration file saved and stored	<input type="checkbox"/> Done	<input type="checkbox"/> Done
<b>Additional Info / Remarks</b>		
<b>I&amp;C Details</b>		
I&C Date		
Installation Team		