

StarterDish™ 27 UM

DIRECTIONAL PARABOLIC DISH ANTENNA

StarterDish™ antennas are designed for CPE applications. Antenna is light weight with their reflector made of aluminium. StarterDish™ antennas provide excellent beam performance in cost effective package. Antennas are easy to assemble and come in highly economical 5 packs.



Gain H

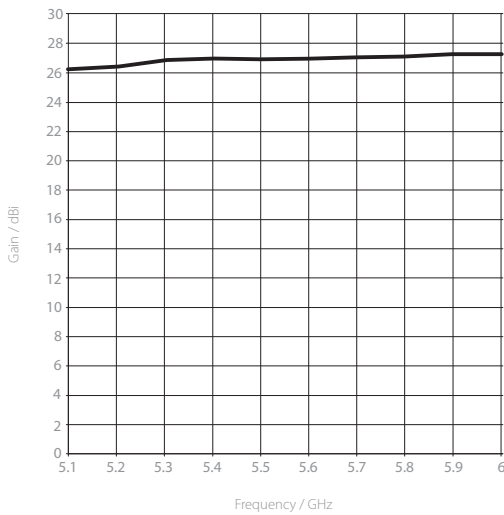

Azimuth Pattern H

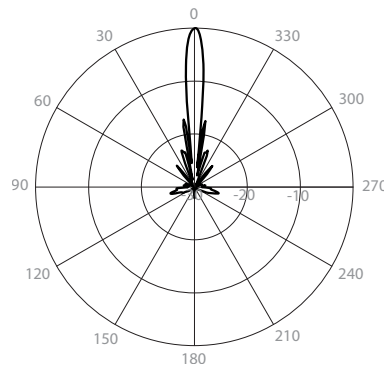

H - Port Pattern Azimuth 5.6 GHz

Elevation Pattern H

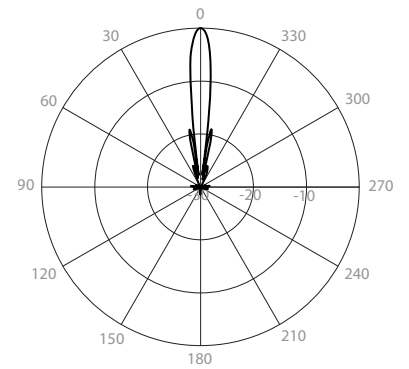

H - Port Pattern Elevation 5.6 GHz

Gain V

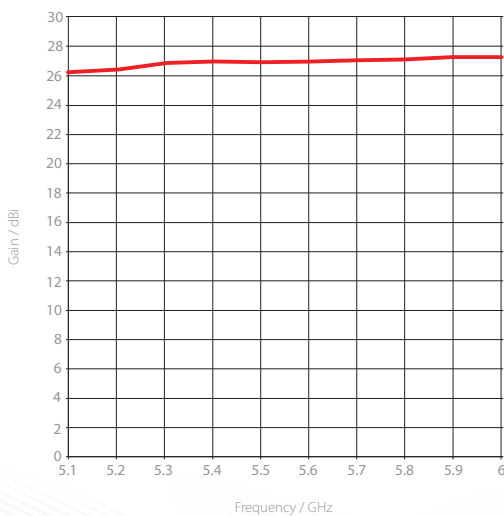

Azimuth Pattern V

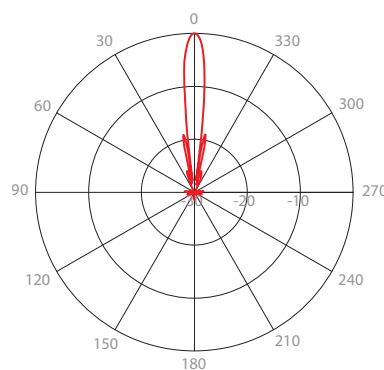

V - Port Pattern Azimuth 5.6 GHz

Elevation Pattern V

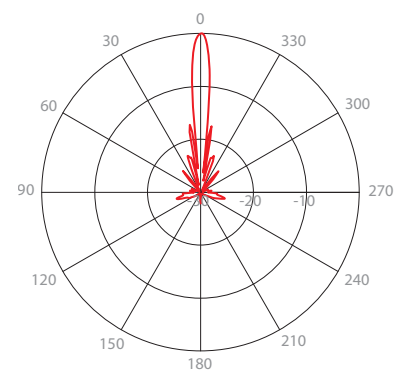

V - Port Pattern Elevation 5.6 GHz

PHYSICAL

Antenna Connection	Waveguide Port
Antenna Type	Parabolic Dish
Environmental	IP65
Pole Mounting Diameter	20-55 mm (recommend as close to 55 mm as possible)
Temperature	-35 °C to + 55 °C (-31 °F to + 131 °F)
Wind Survival	160 km/hour
Wind Loading	252 N at 160 km/hour
Mechanical Adjustment	± 15° Elevation
Weight	2.5 kg / 5.5 lbs – single unit (one antenna) 16 kg / 35.2 lbs – 5PACK (5 units) incl. package
Dimensions	Retail Box 5PACK: 867 x 620 x 112 mm / 34.1 x 24.4 x 4.4 inch

PERFORMANCE

Gain	27 dBi
Frequency Range	5150 - 5950 MHz
Azimuth Beam Width -6 dB	H 8° / V 8°
Elevation Beam Width -6 dB	H 8° / V 8°
Azimuth Beam Width -3 dB	H 6° / V 6°
Elevation Beam Width -3 dB	H 6° / V 6°
Beam Efficiency*	42%
Front-to-Back Ratio (Min)	33 dB

COMPATIBLE WIRELESS PLATFORMS

RF elements®	StarterAdapter™ SMA
Mimosa® by Airspan	C5x
Ubiquiti Networks®	PrismStation™ 5AC, IsoStation™ 5AC, IsoStation™ M5

PRODUCT DIMENSIONS

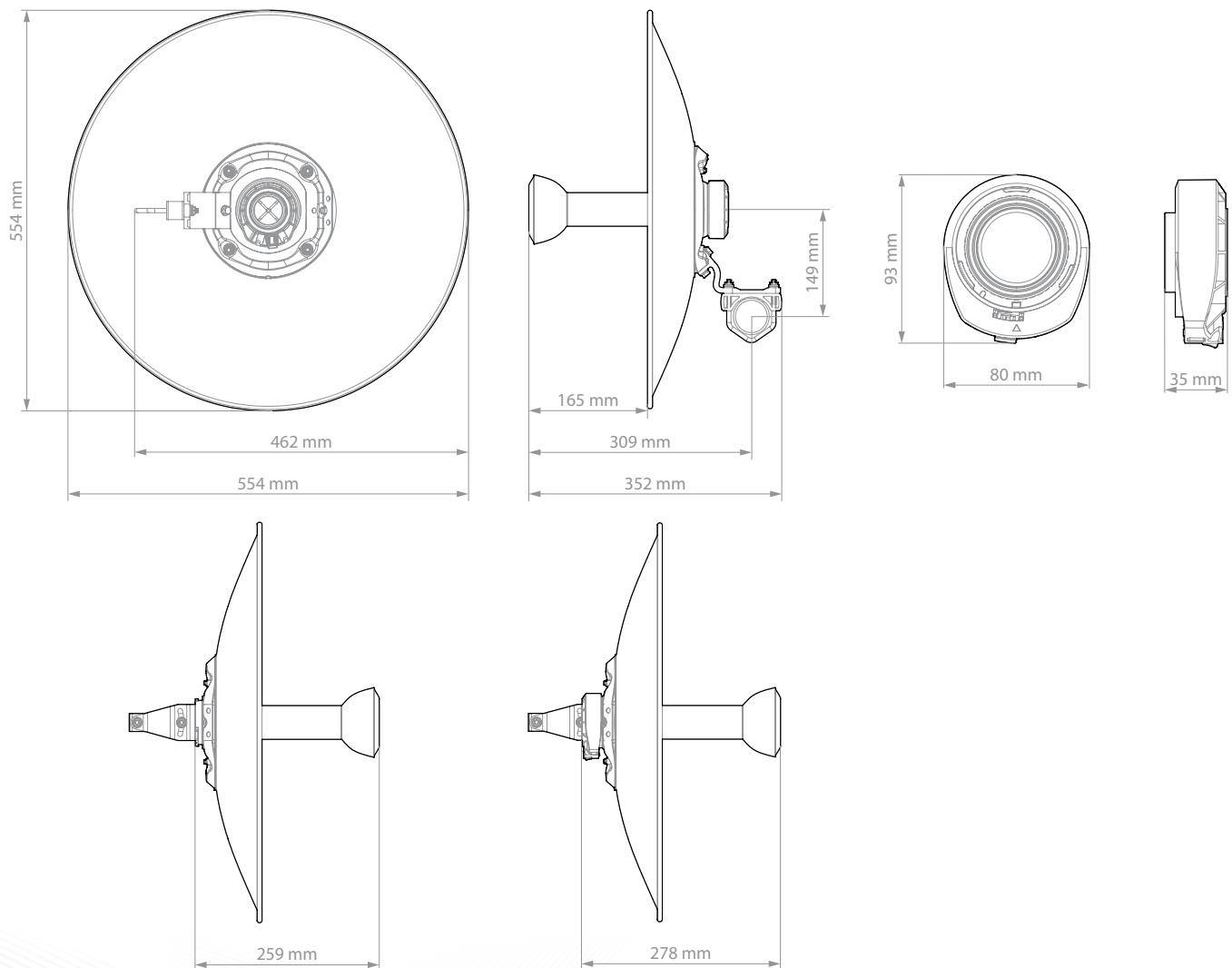

*Main beam defined up to first null