

Huawei OptiXstar EG8041X6-10

Quick Start for QR code

Issue 01
Date 2024-03-25



Copyright © Huawei Technologies Co., Ltd. 2024. All rights reserved.

No part of this document may be reproduced or transmitted in any form or by any means without prior written consent of Huawei Technologies Co., Ltd.

Trademarks and Permissions



HUAWEI and other Huawei trademarks are trademarks of Huawei Technologies Co., Ltd.

All other trademarks and trade names mentioned in this document are the property of their respective holders.

Notice

The purchased products, services and features are stipulated by the contract made between Huawei and the customer. All or part of the products, services and features described in this document may not be within the purchase scope or the usage scope. Unless otherwise specified in the contract, all statements, information, and recommendations in this document are provided "AS IS" without warranties, guarantees or representations of any kind, either express or implied.

The information in this document is subject to change without notice. Every effort has been made in the preparation of this document to ensure accuracy of the contents, but all statements, information, and recommendations in this document do not constitute a warranty of any kind, express or implied.

Huawei Technologies Co., Ltd.

Address: Huawei Industrial Base
Bantian, Longgang
Shenzhen 518129
People's Republic of China

Website: <https://www.huawei.com>

Email: support@huawei.com

Contents

1 Placing the Device.....	1
2 Connecting Cables.....	4
3 Indicator Description.....	6
4 Technical Specifications.....	8
5 FAQs.....	9

1 Placing the Device

NOTE

- Do not install the ONT and user cables outdoors or in an outdoor cabinet.
- The ONT can be mounted onto a wall or placed on a desk. Do not install the ONT in other modes, such as ceiling.
- Keep 10 cm clearance on all sides to ensure adequate ventilation.
- It is recommended that the computer and ONT be put far away from electric appliances that generate strong magnetic or electric fields, such as microwave ovens.
- The ONT applies only to home scenarios, and does not apply to scenarios such as hotels, shops, coffee bars, tea restaurants, Internet cafes, studios, enterprises, or other densely populated scenarios.

Mounting an ONT on the desk

The figure below shows an ONT that is horizontally placed on a desk.

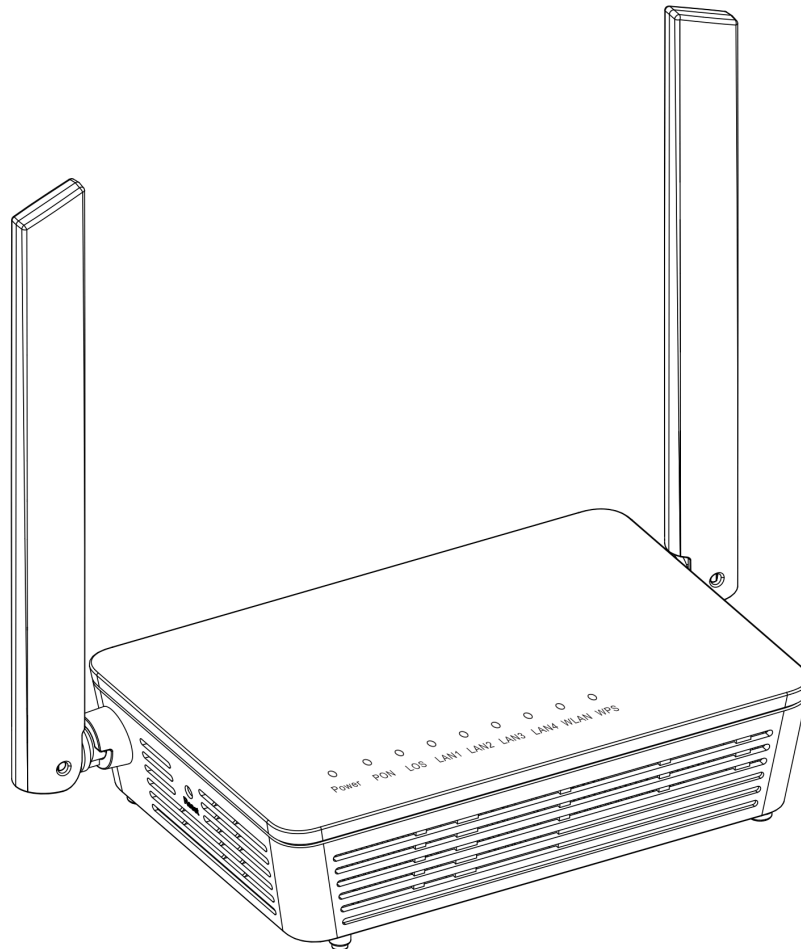

NOTE

The appearance shown in this document may be different from the actual appearance of the product. The actual product prevails.

Mounting an ONT onto the wall

1. Mark two positions with the same spacing as that between the two mounting holes of the ONT using a marker on a wall.
2. Select a proper drill bit according to the outer diameter of the screws. Use a hammer drill to drill the marked positions on the wall. Then clean the holes and install two expansion bolts.
3. Use a screwdriver to fasten the screws into the expansion bolts, reserving 5 mm ends out of the wall, and mount the ONT onto the screws.

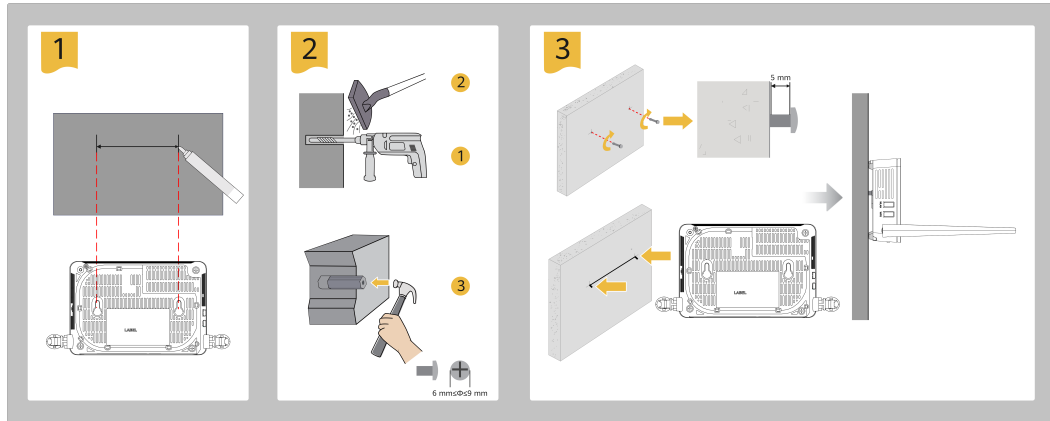

NOTE

It is recommended that the screw be about 4 mm in diameter and longer than 20 mm. The screw head should be between 6 mm and 9 mm in diameter.

2 Connecting Cables

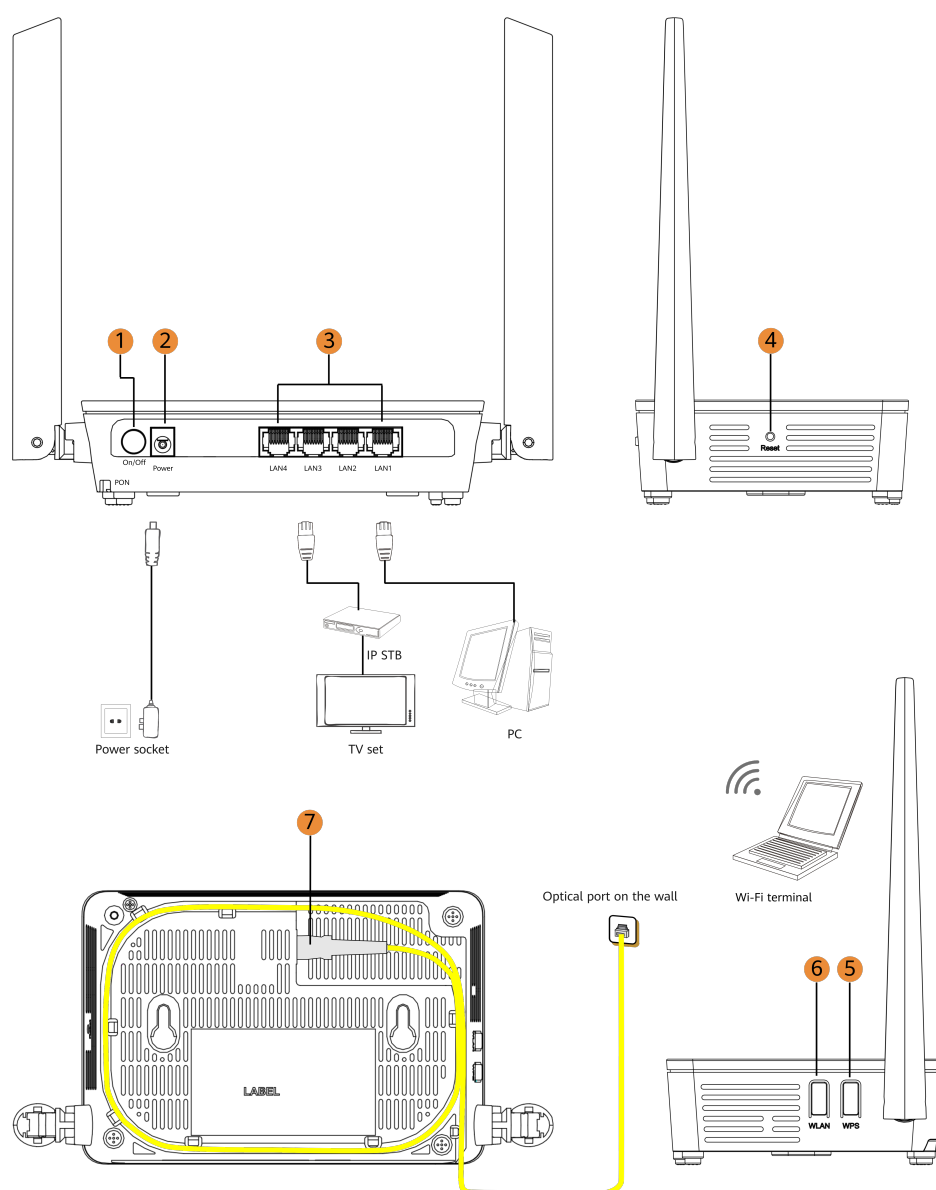

 **NOTE**

- The fiber connector connected to the optical port on the wall varies depending on actual conditions.
- To ensure normal use of fibers, make sure that the fiber bending radius is larger than 30 mm.

No.	Item	Description
1	On/Off	Powers the ONT on or off.
2	Power	Connects to a power adapter.
3	LAN1-LAN4	Connects to PCs or IP set-top boxes (STBs).
4	Reset	<p>Press the button for a short time to reset the device, or press the button for a long time (longer than 10s) to restore the device to the default settings and reset the device.</p> <p>NOTE Reset Huawei ONTs with caution. Otherwise, the ONTs may fail to access the Internet. If an ONT cannot access the Internet after a reset, contact your Internet service provider.</p>
5	WPS	When the WLAN is on, press the WPS button (> 3s) and release the button to start Wi-Fi protected setup (WPS) negotiation.
6	WLAN	<p>Used to enable or disable the WLAN function.</p> <ul style="list-style-type: none"> • When the WLAN is off, press the WLAN button (> 3s) and release the button to open the WLAN. • When the WLAN is on, press the WLAN button (> 3s) and release the button to close the WLAN.
7	Optical port	<p>The optical port is equipped with a rubber plug and connected to a fiber for upstream transmission.</p> <p>The type of the optical connector connected to the optical port can be SC/APC.</p>

3 Indicator Description



Indicator	Status	Description
Power	Steady on	The ONT is powered on.
	Off	The power supply is cut off.
PON/LOS	See the following table.	
LAN1- LAN4	Steady on	The Ethernet connection is in the normal state.
	Blinking	Data is being transmitted on the Ethernet port.
	Off	The Ethernet connection is not set up.
WLAN	Steady on	The WLAN function is enabled.
	Blinking	Data is being transmitted on the WLAN port.
	Off	The WLAN function is disabled.
WPS	Steady on	The WPS function is enabled.
	Blinking	A Wi-Fi terminal is accessing the system.
	Off	The WPS function is disabled.

Status No.	PON Status	LOS Status	Description
1	Off	Off	The ONT is prohibited by the upper-layer device or blinks abnormally. Contact the service provider for help.
2	Blinks twice a second	Blinks twice a second	

Status No.	PON Status	LOS Status	Description
3	Blinks twice a second	Off	The ONT attempts to set up a connection with its upper-layer device.
4	Steady on	Off	A connection is set up between the ONT and its upper-layer device.
5	Off	Blinks once every 2 seconds	The ONT is not connected to fibers or does not receive optical signals.
6	Blinks once every 2 seconds	Blinks once every 2 seconds	The hardware is faulty.

 **NOTE**

If the ONT is not powered on or the power switch is turned off, all indicators are off.

4 Technical Specifications

Product	Function
Huawei OptiXstar EG8041X6-10	<ul style="list-style-type: none">• 4 Ethernet ports• 2.4 GHz & 5 GHz Wi-Fi 6

- Power adapter input: See the nameplate on the adapter.
- System power supply: See the nameplate on the device.
- Ambient temperature: 0°C to +40°C
- Ambient humidity: 5%–95% (non-condensing)
- Dimensions (H x W x D): 35 mm x 155 mm x 105 mm
- Weight: About 238 g
- Maximum system power consumption: 11.7 W

5 FAQs

NOTE

The following web page is only for reference. The actual web page of the product prevails.

How do I log in to the Huawei ONT web page?

NOTE

You are advised to use the latest browser to log in to the web configuration page. Chrome 58/Edge 14/Firefox 54/Safari 10/Opera 55 or later is recommended. If the browser of an earlier version is used, compatibility issues may occur.

- Wireless login
 1. Connect your mobile phone, pad, or PC to the Wi-Fi network of the Huawei ONT.
 2. Enter the IP address in the address box of a browser and press **Enter**. On the displayed login page, enter the username and password. (For details about the IP address, login username, and password, see the product nameplate.)
- Wired login
 1. Use a network cable to connect a PC to the Huawei ONT.

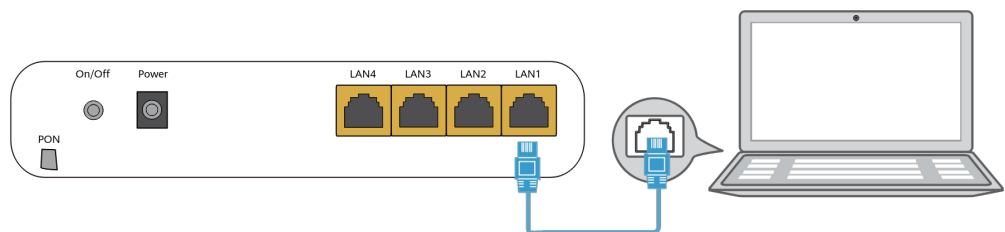

2. Set the IP address of the PC in the same subnet as the web address of the Huawei ONT. *For example, if the web address of the Huawei ONT is 192.168.a.b (for the web address of the Huawei ONT, see the product nameplate), set the IP address of the PC to 192.168.a.c.*

NOTE

The preceding cable connection diagram is only for reference, and those of the actual product prevail.

3. Log in to the web configuration page.

- a. Open a browser. In the address box, enter the web address (printed on the nameplate of the Huawei ONT). Press **Enter**.
- b. Enter the login user name and password (printed on the nameplate of the Huawei ONT). Click **Log In**.

 **NOTE**

- If you do not perform any operations after logging in to the system within five minutes, you will be logged out, and the system automatically returns to the login interface.
- The system will be locked for one minute if you input incorrect user name and password for three consecutive times.
- Change the initial password after logging in to the web page for the first time.

How do I change the Wi-Fi password?

1. Log in to the Huawei ONT web page using your mobile phone, pad, or PC. For details, see "**How do I log in to the Huawei ONT web page?**"
2. Choose the **Advanced > WLAN** tab and choose **2.4G Basic Network Settings**. (If you want to configure 5 GHz Wi-Fi, choose **5G Basic Network Settings**.)

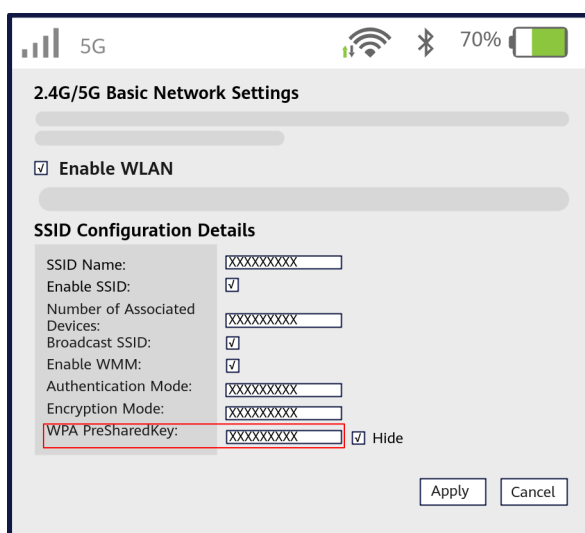

Enter a new password and click "Apply".

What can I do if I forget the Wi-Fi password?

1. Log in to the Huawei ONT web page using your PC by wired login. For details, see "**How do I log in to the Huawei ONT web page?**"
2. Choose the **Advanced > WLAN** tab and choose **2.4G Basic Network Settings**. (If you want to configure 5 GHz Wi-Fi, choose **5G Basic Network Settings**.)

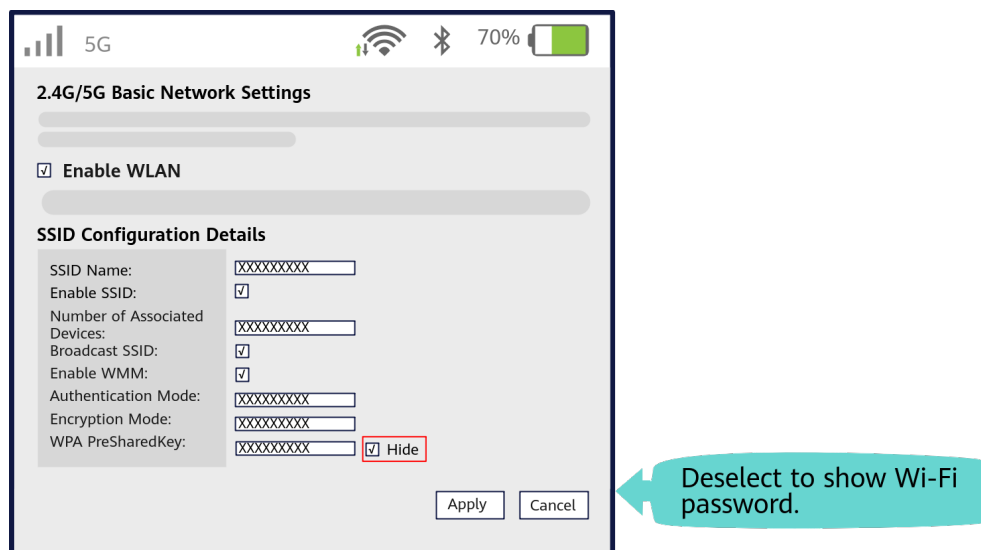

What can I do if I cannot connect to the Wi-Fi network?

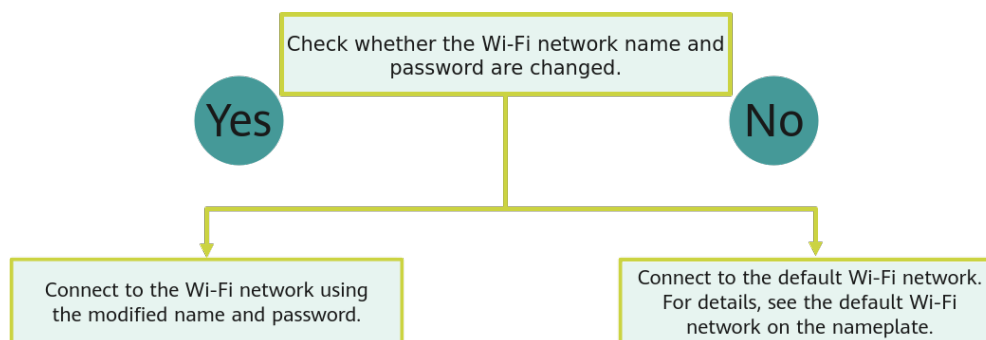

How to improve the Wi-Fi speed of a Huawei ONT?

1. Wi-Fi speed relies on the bandwidth provided by the ISP, so the simplest way is to upgrade to faster broadband.
2. Wi-Fi speed is affected by the Wi-Fi signal strength and quality.
 - 2.1 Determine the deployment positions of ONT based on house structures, indoor obstacles, and electrical appliance-caused interferences. If possible, put ONT in the middle of a planned coverage area and ensure that no obstacles exist and they are placed at high positions for better coverage. In addition, ensure that the ONT is far away from interference sources such as TVs, refrigerators, cordless phones, and Bluetooth devices.
 - 2.2 Note that load-bearing walls, floors, and metal coated glass may block Wi-Fi signals, avoid or reduce these obstacles between the ONT and Wi-Fi devices (such as pads, mobile phones, and laptops). For outdoor yards, large balconies, and compound rooms, etc., it is recommended to add repeaters to enhance the Wi-Fi coverage.
 - 2.3 For common places where users access the Internet, such as a living room, study room, or master room, pre-evaluate whether their signal strength is strong enough. If the signal strength is insufficient (Generally, lower than -72dBm), it is

recommended to adjust ONT positions or add new repeaters to enhance the Wi-Fi coverage.

3. Using the correct radio channel. Generally, the Huawei ONT automatically selects the optimal channel. If the network is slow or the quality turns poor from time to time, you can use a Wi-Fi scanner such as Wi-Fi Stumbler or Wi-Fi Analyzer to search for the optimal channel.

4. To prevent unauthorized network access, log in to the web interface of the ONT and select MAC address filtering based on your requirements.

What can I do if the network speed is slow?

1. Check whether network cables are properly connected. Remove and then insert the network cables. Then, check whether the network speed is normal.
2. Check whether downloading, network video watching, or other operations occupy a large amount of bandwidth. Due to bandwidth restrictions, if some network applications occupy a large amount of network bandwidth, the network speed is slow.
3. Use another PC, mobile phone, or pad to check whether the network speed is normal.

How do I restore the Huawei ONT to factory setting?

Press **Reset** by using a needle-type object for longer than 10s to restore factory defaults and reset the Huawei ONT. If the indicator is off and then is lit, the system restarts successfully.

NOTE

Exercise caution when restoring factory settings. This function may cause the loss of ONT configuration information and further cause an Internet access failure. If this problem occurs, contact your service provider for help.

How can I download Huawei ONT firmware or software?

Huawei ONT is used with an OLT and NMS of a required version. If the versions are not the required ones, the ONT may not work.

If required, contact your internet service provider to obtain the correct ONT firmware or software.