



Grandstream Networks, Inc.

GXW45xx Series

User Manual



GXW4500 Series – User Manual

Thank you for purchasing the Grandstream GXW450X Digital VoIP Gateway. The GXW450X offers an easy-to-manage, easy-to-configure IP communications solution for any business with virtual and/or branch locations. The GXW450X supports popular voice codecs and is designed for compatibility and interoperability with third-party SIP providers, thus enabling you to fully leverage the benefits of VoIP technology, integrate an IP system into a VoIP network, and efficiently manage GXW450x supports SNMP (Simple Network Management Protocol) which is widely used in network management for network monitoring for collecting information about monitored devices. To configure SNMP settings, go to GXW450x Web **GUI→System Settings→SNMP** communication costs.

This manual will help you learn how to operate and manage your GXW450X Digital Gateway and make the best use of its many upgraded features: including simple and quick installation, multi-party conferencing, and direct IP-IP Calling. This Digital VoIP Gateway is very easy to manage and specifically designed to be an easy-to-use and affordable VoIP solution for large and medium-sized enterprises

Safety Compliances

The GXW450X is compliant with various safety standards including FCC/CE. Its power adapter is compliant with UL standards.

Warning:

Use only the power adapter included in the GXW450X package. The use of an alternative power adapter may permanently damage the unit.

Warranty:

Grandstream has a reseller agreement with our reseller customers. End users should contact the company from whom the product was purchased, for replacement, repair, or refund.

If you purchased the product directly from Grandstream, contact your Grandstream Support for an RMA (Return Materials Authorization) number. Grandstream reserves the right to change the warranty policy without prior notification.

Caution

Changes or modifications to this product not expressly approved by Grandstream, or operation of this product in any way other than as detailed by this User Manual, could void your manufacturer warranty.

GATEWAY GXW450X OVERVIEW

The GXW450X series are E1/T1/J1 Digital VoIP Gateways that allow digital PSTN and ISDN trunks to be integrated with VoIP networks. By connecting GXW450X series with a VoIP network and traditional PBX or E1/T1/J1 providers, businesses can drastically increase the number of PSTN/ISDN trunks integrated with their VoIP network and the concurrent calls supported. The GXW450X series offers three models that provide 1, 2, or 4 T1/E1/J1 ports and support 30, 60, or 120 concurrent calls.

Feature Highlights

The following table contains the major features of the GXW450X:

 <p>GXW450X</p>	<ul style="list-style-type: none">○ 1, 2 or 4 Software configurable E1/T1/J1 ports○ Support of PRI, SS7 and MFC R2 Signaling protocols○ Dual Gigabit Auto-sensing RJ45 Network ports with integrated NAT router○ Support of T.38 FAX for creating Fax-over-IP○ Support of a wide range of voice codecs, including G.722, G.729, iLBC, OPUS, and more○ TLS and SRTP security encryption technology to protect calls and accounts○ Support of multi-language voice prompt○ Supports up to 120 concurrent calls
---	---

Table 1: GXW450X Features Highlights

GXW450X Technical Specifications

The following table resumes all the technical specifications including the protocols/standards supported, voice codecs, languages, and upgrade/provisioning settings for the GXW450X

Interfaces	
T1/E1/J1 Interface	1/2/4 RJ45 ports, supporting up to 30/60/120 simultaneous VoIP calls
Network Interfaces	Dual self-adaptive Gigabit ports (switched or routed)
Peripheral Ports	(2) USB 3.0, (1) SD card interface
LED Indicators	WAN, LAN, T1/E1/J1
LCD Display	128×32 dot matrix graphic LCD with DOWN and OK buttons
Reset Switch	Yes, long press for factory reset and short press for the reboot.
Voice Capabilities	
Voice-over-Packet Capabilities	LEC with NLP Packetized Voice Protocol Unit, 128ms-tail-length carrier grade Line Echo Cancellation, Dynamic Jitter Buffer, Modem detection & auto-switch to G.711
Voice and Fax Codecs	G.711 A-law/U-law, G.722, G.723.1 5.3K/6.3K, G.726, G.729A/B, Opus, iLBC, GSM-FR, AAL2-G.726-32
Fax over IP	T.38 compliant Group 3 Fax Relay up to 14.4kpbs and auto-switch to G.711 for Fax Passthrough, Fax data pump V.17, V.27ter, V.29 for T.38 fax relay.
Voice-quality Enhancement	Echo cancellation (G.168-2004), Jitter buffer, Silence suppression (VAD, CNG), PLC
QoS	Layer 2 QoS (802.1Q, 802.1p) and Layer 3 (ToS, DiffServ, MPLS) QoS
Signaling & Control	
DTMF Methods	In-band audio, RFC2833, and/or SIP INFO
Digital Signaling	SIP (RFC 3261) over UDP/TCP/TLS, PRI, SS7, MFC R2, RBS (pending) PRI switch types: Euro ISDN, nation, Q.SIG CAS: MFC R2 (Argentina, Brazil, China, Czech Republic, Colombia, Ecuador, Indonesia, ITU, Mexico, Philippines, Venezuela) SS7: ITU, ANSI, China
Upgrade	Firmware upgrade via TFTP / HTTP / HTTPS or local HTTP upload
Device Management	Syslog, HTTPS, Web browser, voice prompt, backup and restore, port capture, and packet capture
Network Protocols	TCP/UDP/IP, RTP/RTCP, ICMP, ARP, DNS, DDNS, DHCP, NTP, TFTP, SSH, HTTP/HTTPS, PPPoE, STUN, SRTP, TLS, LDAP, PPTP, Frame Relay (pending), IPV6, OpenVPN®
Status and statistic	Call status and history, device status monitoring, and ISDN status monitoring
Security	
Media Encryption	SRTP, TLS, HTTPS, SSH, 802.1X
User-defined ports	SIP port, RTP port, HTTP/HTTPS port

Advanced Defense	Fail2ban, alert events, Whitelist, Blacklist, strong password-based access control
Physical	
Universal Power Supply	Input: 100-240VAC, 50/60Hz Output: DC+12V/2A
Physical & Dimensions	GXW4501: Unit Weight: 2350g; Package Weight: 3130g GXW4502: Unit Weight: 2360g; Package Weight: 3140g GXW4504: Unit Weight: 2380g; Package Weight: 3160g Unit Dimensions: 485mm(L) x 191mm(W) x 46.2mm (H)
Temperature and Humidity	Operating: 32 – 113°F / 0 ~ 45°C, Humidity 10 – 90% (non-condensing) Storage: 14 – 140°F / -10 ~ 60°C, Humidity 10 – 90% (non-condensing)
Mounting	Rack mount & Desktop
Additional Features	
Multi-Language Support	Web UI: English, Simplified Chinese, Traditional Chinese, Spanish, French, Portuguese, German, Russian, Italian, Polish, C Customizable IVR/voice prompts: English, Chinese, British English, German, Spanish, Greek, French, Italian, Dutch, Polish Portuguese, Russian, Swedish, Turkish, Hebrew, Arabic; Customizable language pack to support any other languages
Compliance	FCC: 47 C.F.R FCC Part 15 Class B; 47 C.F.R FCC Part 68 (TIA-968-B Section 5.2.4 (T1+ISDN)) CE : EN 55032,EN 55035,EN 61000-3-2,EN 61000-3-3,EN 60950-1,TBR 4 (E1+ISDN),TBR 12 (E1),TBR 13 (E1+ISDN) RCM: AS/NZS CISPR 32,AS/NZS 61000.3.2,AS/NZS 61000.3.3,AS/NZS 60950.1,AS/ACIF S016(E1),AS/ACIF S038(E1+ISDN) Other: ITU K.21 (Enhanced Levels); UL 60950-1 (Power adapter)

Table 2: GXW450X Technical Specifications

GETTING STARTED

This chapter provides basic installation instructions including the list of the packaging contents and also information for obtaining the best performance with the GXW450X.

Equipment Packaging

Unpack and check all accessories. Equipment includes

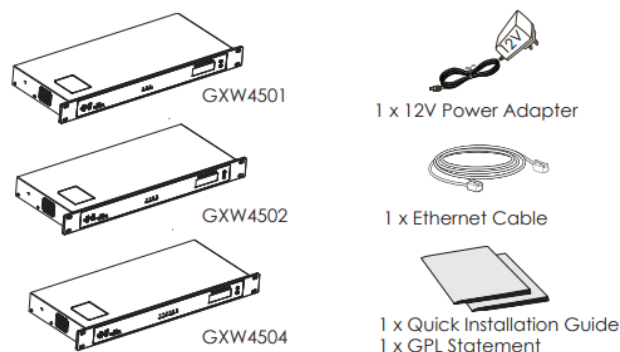

Figure 1: GXW450X Package Contents

Connecting the GXW450X

Connecting the GXW450X gateway is easy. Follow these steps to connect your GXW450X gateway to the Internet and access the unit's configuration pages.

1. Connect one end of a straight-through RJ45 Ethernet cable into the WAN port of the GXW450X; connect the other end to the uplink port of an Ethernet switch/hub.
2. Connect the 12V DC power adapter to the DC 12V power jack on the back of the GXW450X. Insert the main plug of the power adapter into a protected power outlet.
3. Connect one end of the T1/E1/J1 cable provided by the service provider into the T1/E1/J1 port of the GXW450X; connect the other end to the T1/E1/J1 wall jack.
4. Wait for the GXW450X to boot up. The front LCD display will show the GXW450X hardware information when the boot process is completed.
5. Once the GXW450X is successfully connected to the network via the WAN port, the Network LED indicator will be lit green, and an IP address shown on the LCD display.

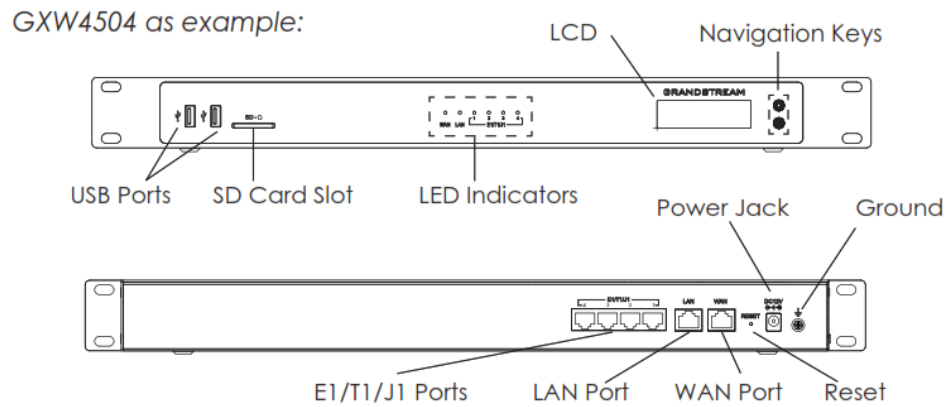

Figure:2 Diagram of GXW4504 Back and Front Panel

WAN/LAN ports	Ethernet ports used to connect the GXW to the local and external network
RESET	Factory Reset button. Press and hold for a while to reset the factory default settings.
Power Jack	Power adapter connection
E1/T1/J1 ports	Digital port to be connected to a digital line.
USB port	2 Ports used to connect external USB drives to the GXW
SD Card Slot	Reads the SD cards memory
Ground	The ground screw needs to be connected to the ground.

Table 3: Definitions of the GXW450X Connectors

Using GXW450X Keypad Menu

The keypad menu of the GXW450X consists of 2 buttons: OK and Down keys to navigate different options.

1. Press the "OK" key to start browsing menu options.
2. Press "Down" to browse different menu options. Press "OK" to select an entry.
3. In the menu option, select "Back" to go back to the previous menu.
4. The LCD will return to default display after being idle in the menu for longer than 20 seconds.

The following table shows the LCD menu options.

View Events	<ul style="list-style-type: none"> ○ Critical Events ○ Other Events
Device Info	<ul style="list-style-type: none"> ○ Hardware: Hardware version number ○ Software: Software version number ○ P/N: Part number ○ MAC: Device MAC address ○ Uptime: System up time since the last reboot
Network Info	<ul style="list-style-type: none"> ○ LAN Mode: DHCP, Static IP or PPPoE ○ LAN IP: IP address ○ LAN Subnet Mask
Network Menu	<ul style="list-style-type: none"> ○ LAN Mode: Select LAN mode as DHCP, Static IP or PPPoE ○ Static Routes Reset: Click to reset the static route setting
Factory Menu	<ul style="list-style-type: none"> ○ Reboot ○ Factory Reset ○ LCD Test Patterns <p>Press "OK" to start. Then press the "Down" button to test different LCD patterns. When done, press the "OK" button to exit.</p> <ul style="list-style-type: none"> ○ Fan Mode <p>Select "Auto" or "On".</p> <ul style="list-style-type: none"> ○ LED Test Patterns <p>Select "All On" "All Off" or "Blinking" and check the LED status for USB, SD, T1/E1/J1, Phone 1/Phone 2, Line 1/Line 2 ports. After the test, select "Back" in the menu, and the device will show the LED actual status again.</p> <ul style="list-style-type: none"> ○ RTC Test Patterns <p>Select "2022-02-22 22:22" or "2011-01-11 11:11" to start the RTC (Real-Time Clock) test pattern. Check the system time from LCD idle screen by pressing the "DOWN" button, or from the Web GUI→System Status→General page. After the test, reboot the device manually and the device will display the correct time.</p> <ul style="list-style-type: none"> ○ Hardware Testing <p>Select "Test DSP" to perform the DSP test on the device. This is mainly for factory testing purposes which verifies the hardware connection inside the device. The diagnostic result will display on the LCD after the test is done.</p>
Default Password	Showing the default Web login password. Once the password was changed, this menu will not show again.
Web Info	<ul style="list-style-type: none"> ○ Protocol: Web access protocol. HTTP or HTTPS. By default, it's HTTPS ○ Port: Web access port number. By default, it's 8089
SSH Switch	<ul style="list-style-type: none"> ○ Enable SSH: Enable SSH access. ○ Disable SSH: Disable SSH access. <p>By default, SSH access is disabled.</p>

Table 4: LCD Menu Options

Use the LED Indicators

The GXW450X has LED indicators in the front to display the connection status. The following table shows the status definitions.

LED Indicator	LED Status
Power LAN WAN	<ul style="list-style-type: none"> ○ Solid: Connected ○ OFF: Disconnected
T1/E1/J1	<ul style="list-style-type: none"> ○ Solid: Connected and working ○ Blinking: No cable is connected; or connected but the link is not working at all.

Table 5: GXW450X LED Indicators

Configuring GXW450X via Web GUI

Web GUI Access

The GXW450X embedded Web server responds to HTTP/HTTPS GET/POST requests. Embedded HTML pages allow users to configure the device through a Web browser such as Microsoft IE, Mozilla Firefox, or Google Chrome.

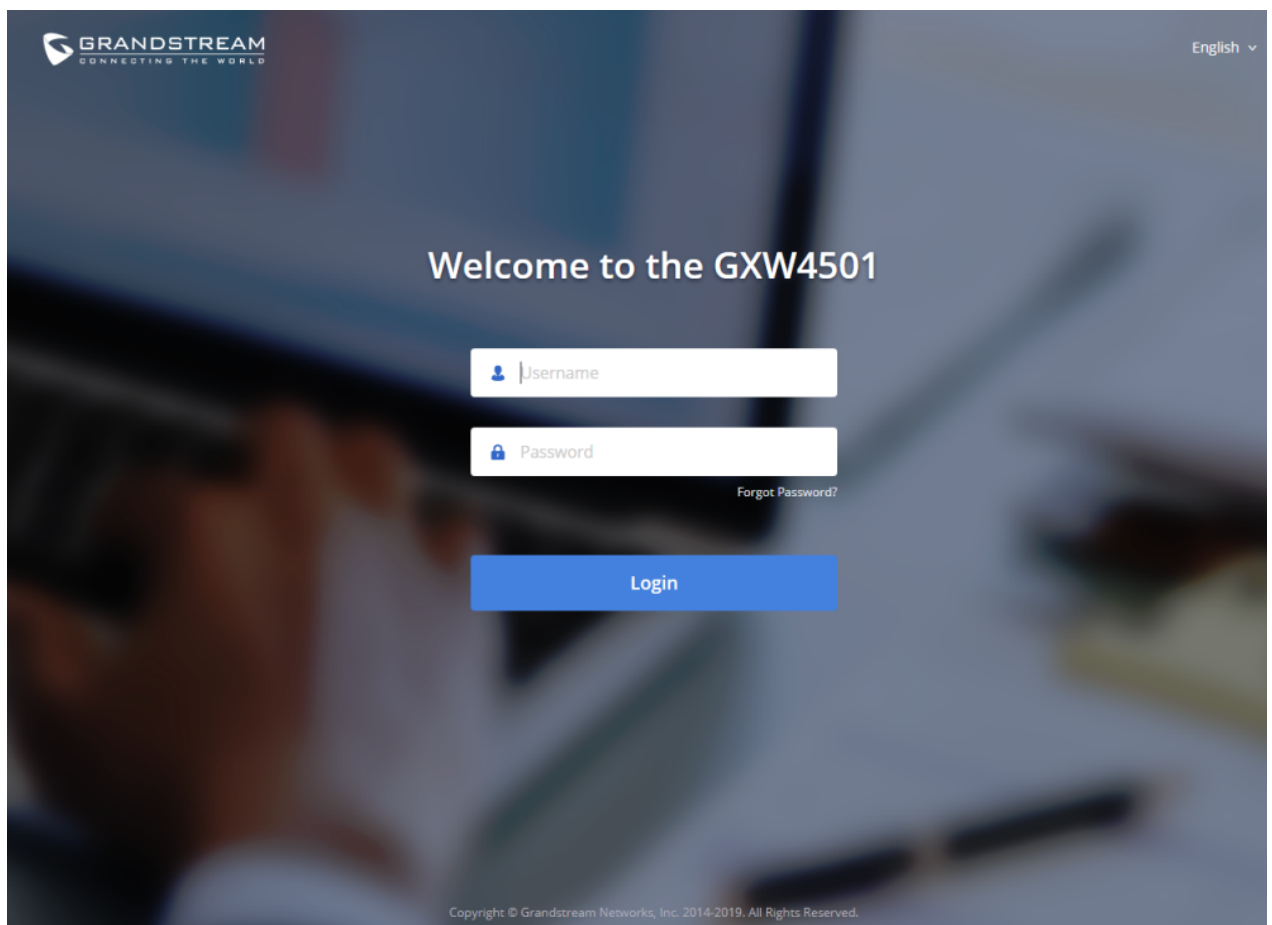

Figure 3: GXW450X Web GUI Login Page

To access the Web GUI:

1. Connect the computer to the same network as the GXW450X.
2. Ensure the GXW450X is properly powered on and displays the IP address on the LCD screen.
3. Open a web browser on the computer and enter the displayed IP address into the search bar in the following format:
https://ipaddress:portnumber
4. Enter username and password to login. (The default administrator username is "admin" and the default random password can be found on the sticker on the GXW450X).

Reset Password at First Login

At first login, users will be forced to change the default admin password. The following screen will be shown, enter the requested information to p

- o **Enter New Password**
- o **Re-enter New Password**
- o **Email Addresses:** Email to be used to recover the password if lost.

Press "Confirmed" to apply the settings and access the web GUI.

GXW4501

EN

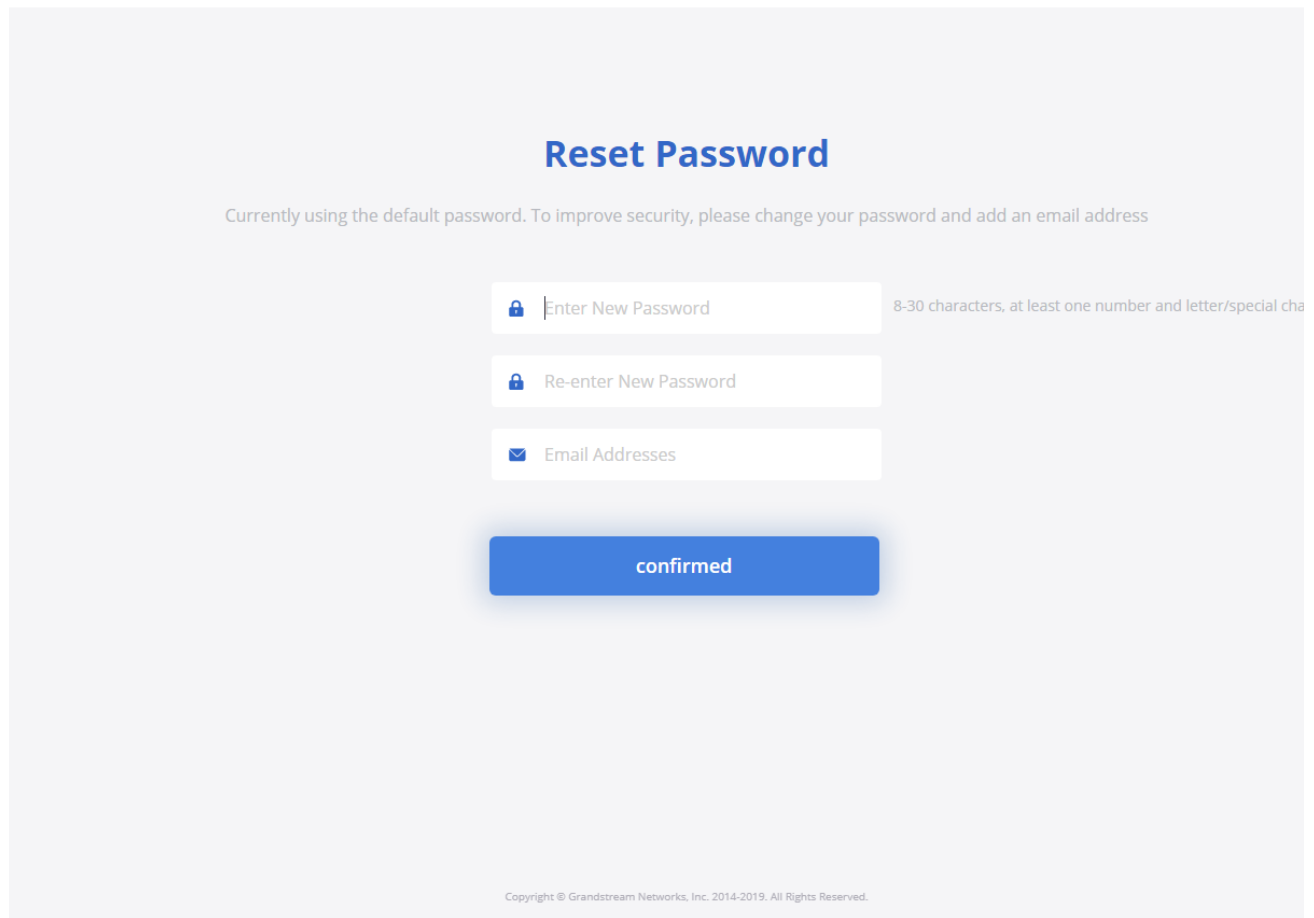

Reset Password

Currently using the default password. To improve security, please change your password and add an email address

Enter New Password 8-30 characters, at least one number and letter/special cha

Re-enter New Password

Email Addresses

confirmed

Copyright © Grandstream Networks, Inc. 2014-2019. All Rights Reserved.

Figure 4: Reset Password

Setup Wizard

When the user logs in to the GXW450X Web GUI for the first time, he will be asked to change the default password and add an email address to improve security, and a setup wizard will provide guidance to set up basic configuration. Configurations in the setup wizard include Network settings, Time and Trunk/routes.

GXW4501 Setup Wizard English

Setup Wizard

1 Network Settings 2 Select Time Zone 3 Digital Hardware 4 Trunks / Routes 5 Su

Network Settings

Method:

MTU:

Preferred DNS Server:

WAN

IP Method:

Layer 2 QoS 802.1Q/VLAN Tag:

Layer 2 QoS 802.1p Priority Value:

LAN

• IP Address:

• Subnet Mask:

DHCP Server Enable:

• DNS Server 1:

DNS Server 2:

• Allow IP Address From:

• Allow IP Address To:

• Default Gateway:

• Default IP Lease Time:

Layer 2 QoS 802.1Q/VLAN Tag:

Layer 2 QoS 802.1p Priority Value:

Figure 5: GXW450X Setup Wizard

Web GUI Configurations

There are six main sections in the Web GUI for users to view the Gateway status and configure and manage the GXW450X.

- **System Status:** Displays GXW450X Dashboard, System Information, Active calls, and network status.
- Trunk: To Digital and VoIP trunks and manage inbound/outbound call routes.
- Gateway Settings: SIP Settings, RTP Settings, and interface settings.
- **System Settings:** To configure The HTTP server, network settings, OpenVPN®, security settings, Email Settings, and Time Settings.
- **Maintenance:** To perform the firmware upgrade, backup configurations, user management cleaner setup, reset/reboot, Syslog setup, and troubleshooting
- **CDR:** View call records and download CDR reports.

Web GUI Languages

Currently the GXW450X series Web GUI supports **English, Simplified Chinese, Traditional Chinese,**

Spanish, French, Portuguese, Russian, Italian, Polish, German, etc.

Users can select the displayed language on the Web GUI login page or at the upper right tab of the Web GUI after logging in.

GXW4501 Setup Wizard English

Menus **System Status**

- Dashboard
- System Information
- Active Calls
- Network Status

Dashboard

Space Usage

Configuration Partition

Data Partition

Resource Usage

10%
8%
6%
4%
...

Memory Usage **9%**
Total: 1884

CPU Usage

English
简体中文
繁體中文
Español
Français
Português
Русский
Italiano

Storage Capa
Drive Insert
Drive Insert



Figure 6: GXW450X Web GUI Languages

Save and Apply Changes

Click on the “Save” button after configuring the Web GUI options on one page. After saving all the changes, make sure to click on the “Apply Changes” button on the upper right of the web page to submit all the changes. If the change requires a reboot to take effect, a prompted message will pop up to you to reboot the device.

SYSTEM STATUS

The System Status section is the interface that allows users to check the general information about the GXW450X such as software and hardware information, space usage, resources usage, etc.

Dashboard

The GXW450X monitors the status of Trunks, Digital Channels, Disk capacities, etc. It presents administrators with the real-time status in different sections under the Web GUI → **System Status** → **Dashboard**.

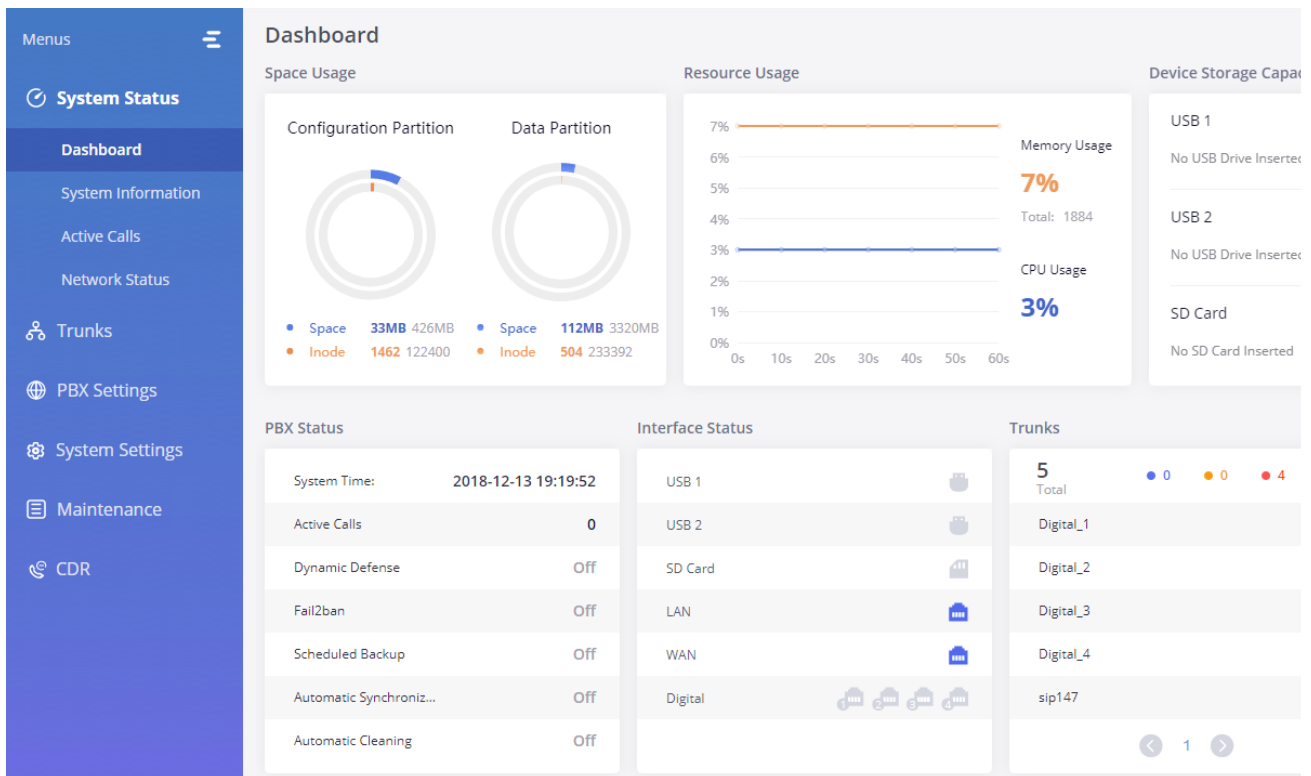

Figure 7: GXW450X Dashboard

Space Usage

Users could access the space usage information from Web GUI→**System Status**→**Dashboard** →**Space Usage**. It shows the available and used space for Space Usage and Inode Usage.

Space Usage includes:

- **Configuration partition:** This partition contains GXW450X system configuration files and service configuration files.
- **Data partition:** CDR records, Voice Prompts, etc.

Inode Usage includes:

- Configuration partition
- Data partition

Note: Inode is the pointer used for file reference in the system. The system usually has limited resources of pointers.

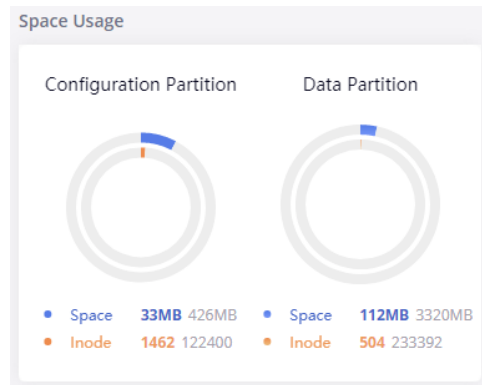

Figure 7: Space Usage

Resource Usage

When configuring and managing the GXW450X, users could access resource usage information to estimate the current usage and allocate the resources accordingly. Under Web GUI→**System Status**→**Dashboard** →**Resource Usage**, the current CPU usage and Memory usage are shown in this chart.

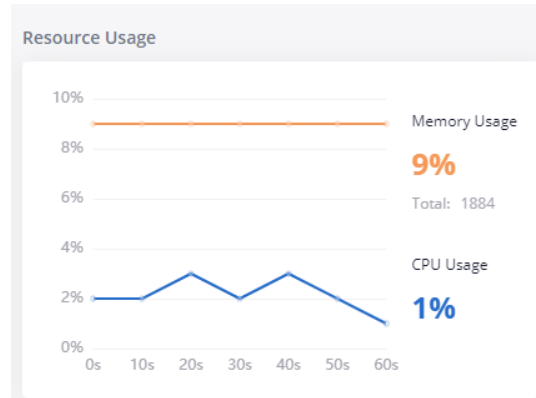

Figure 8: Resource Usage

Disk Capacity

Users could check the external devices' capacities from the Dashboard page of the GXW450X under Web GUI→**System Status**→**Dashboard** →**Disk Storage Capacity**.

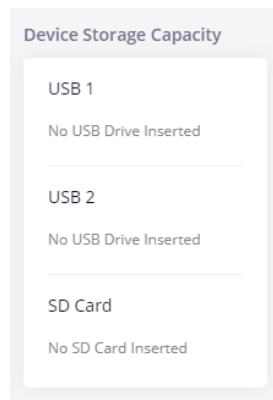

Figure 9: Device Storage Capacity

PBX Status

The PBX status shows the status of some of the gateway GXW450X services. Among the services monitored on the PBX status tab, there is System Active Calls, Schedule backup, etc.

PBX Status	
System Time:	2018-12-13 19:44:06
Active Calls	0
Dynamic Defense	Off
Fail2ban	Off
Scheduled Backup	Off
Automatic Synchroniz...	Off
Automatic Cleaning	Off

Figure 10: PBX Status

Interfaces Status

This section displays the interface connection status on the GXW450X for USB, SD Card, LAN, WAN, and Digital interfaces.

Interface Status	
USB 1	
USB 2	
SD Card	
LAN	
WAN	
Digital	

Figure 11: Interface Status

Trunks

Users could see all the configured trunks' status in this section.

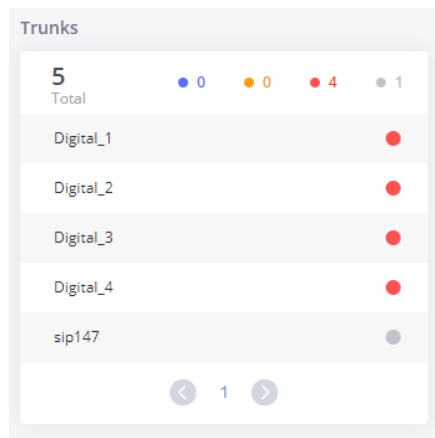

Figure 12: Trunks Status

Four statuses are possible for any trunk configured on the GXW450X:

- Available
- Busy
- Abnormal
- Unmonitored

To visualize the state of each channel of the Digital trunk, users can waver the mouse over the status of the digital trunk as shown on the figure below.

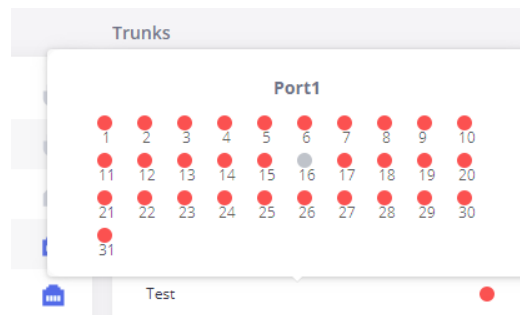

Figure 13: Digital Trunk Channels Status

System Information

The GXW450X system Information can be accessed via Web GUI→**System Status**→**System Information**, which displays the following system information.

General

On this menu, users could check the hardware and software information for the GXW450X. Please see the details in the following table.

System Information	
Model	Product model.
Part Number	Product part number.
System Time	Current system time. The current system time is also available on the upper right of each web page.
Up Time	System up time since the last reboot.
Version Information	
Boot	Boot version.
Core	Core version.
Base	Base version.

Program	Program version. This is the main software release version.
Recovery	Recovery version.

Table 6: System Information → General

System Information

General Network

System Information

Model: GXW4501 V1.2A

Part Number: 9660003712A

System Time: 2019-08-29 12:15:29 UTC-04:00

Up Time: 07:44:06

Version Information

Boot: 1.0.0.27

Core: 1.0.0.27

Base: 1.0.0.27

Lang: 1.0.0.27

Program: 1.0.0.27

Recovery: 1.0.0.27

Figure 14: System Information → General

Network

Under Web GUI → **System Status** → **System Information** → **Network**, users could check the network information for the GXW450X. Please see the c in the following table.

WAN/LAN	
MAC Address	Global unique ID of the device, in HEX format. The MAC address can be found on the label coming with the original box and or label located at the bottom of the device.
IPv4 Address	The IPv4 address attributed to the network interface
IPv6 Address	The IPv6 address attributed to the network interface
IPv6 Address Link	The IPv6 address Link attributed to the network interface
Gateway	Default gateway address.
Subnet Mask	Subnet mask address.
DNS Server	DNS server address.

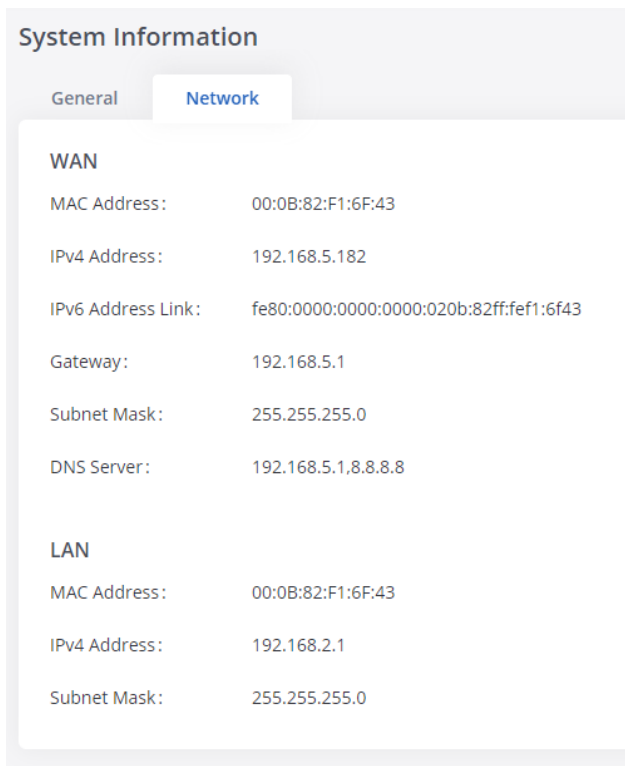

Figure 15: System Information → Network

Active Calls

The active calls on the GXW450X are displayed on the Web GUI → **System Status** → **Active Calls** page. Users can monitor call status and hang up a call(s) in a real-time manner.

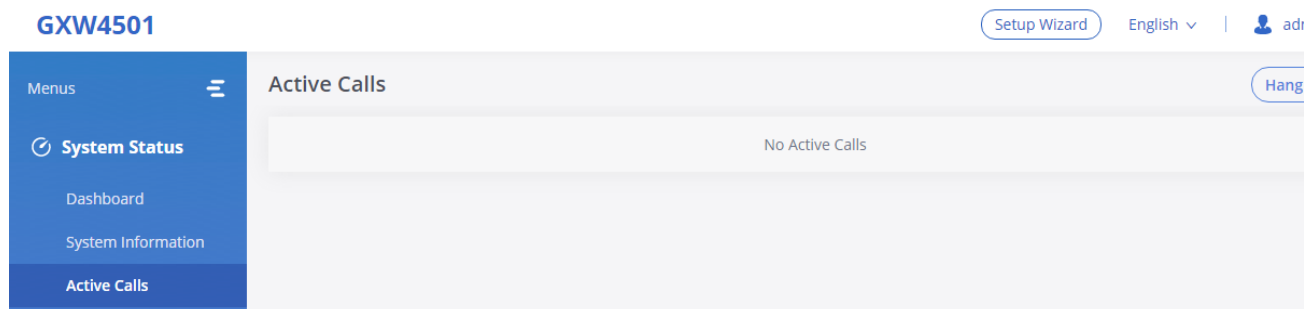

Figure 16: Active Calls

Users can click on "Hang up All" to terminate all the active calls at once.

Network status

GXW450X supports Network Status to display active internet connections. Users can use Network Status to troubleshoot connection issues between GXW450X and other services. This information can be found under Web GUI → **System Status** → **Network Status**, the users can view active Internet connections and the Active Unix Domain Sockets.

Network Status					
Active Connections		Active Unix Domain Sockets			
Proto	Recv-Q	Send-Q	Local-Address	Foreign-Address	State
tcp	0	0	0.0.0.0:8088	0.0.0.0:*	LISTEN
tcp	0	0	0.0.0.0:8888	0.0.0.0:*	LISTEN
tcp	0	0	127.0.0.1:25	0.0.0.0:*	LISTEN
tcp	0	0	0.0.0.0:7777	0.0.0.0:*	LISTEN
tcp	0	0	0.0.0.0:7681	0.0.0.0:*	LISTEN
tcp	0	0	127.0.0.1:7777	127.0.0.1:36727	TIME_WAIT
tcp	0	0	127.0.0.1:7777	127.0.0.1:36728	TIME_WAIT
tcp	0	0	127.0.0.1:7681	127.0.0.1:40182	ESTABLISHED
tcp	0	0	127.0.0.1:40182	127.0.0.1:7681	ESTABLISHED

Figure 17: Active connections

Network Status					
Active Connections		Active Unix Domain Sockets			
Proto	RefCnt	Flags	Type	State	I-Node
unix	2	[ACC]	SEQPACKET	LISTENING	9226
unix	9	[]	DGRAM		11548
unix	2	[ACC]	STREAM	LISTENING	1922
unix	2	[ACC]	STREAM	LISTENING	10371
unix	2	[]	DGRAM		10384
unix	2	[ACC]	STREAM	LISTENING	12486
unix	2	[ACC]	STREAM	LISTENING	13150

Figure 18: Active Unix Domain Sockets

SYSTEM SETTINGS

This chapter explains configurations for system-wide parameters on the GXW450X. System settings are under the "System Settings" tab on GXW450X Web GUI. System settings include Network Settings, Security Settings, HTTP Server, Email Settings, Time Settings, OpenVPN® settings, and DDNS Settings.

HTTP Server

The GXW450X embedded web server responds to HTTP/HTTPS GET/POST requests. Embedded HTML pages allow the users to configure the gateway through a Web browser such as Microsoft IE, Mozilla Firefox, and Google Chrome. By default, the Gateway can be accessed via HTTPS using Port 8089 (e.g., https://192.168.1.50:8089). Users could also change the access protocol and port as preferred under Web GUI → **System Settings** → **HTTP Server**.

Basic Settings	
Redirect From Port 80	Enable or disable redirect from port 80. On the gateway, the default access protocol is HTTPS and the default port number is 8089. When this option is enabled, the access using HTTP with Port 80 will be redirected to HTTPS with Port 8089. The default setting is "Enable".
Protocol Type	Select HTTP or HTTPS. The default setting is "HTTPS". This is also the protocol used for zero config when the endpoint device downloads the config file from the GXW450X.
Port	Specify the port number to access the HTTP server. The default port is 8089.

Enable IP whitelist	If enabled, only the IP address on the permitted IP list will be allowed to access the GXW450X's web GUI.
Permitted IP(s)	Add an IP address to the list of allowed IPs to access GXW450X's web GUI. Ex: 192.168.6.233 / 255.255.255.255
Certificate Settings	
Options	Select the mode to download SSL certificates for the web server, two modes are available: <ul style="list-style-type: none"> ○ Manually Upload certificate: Upload the files while respecting size and format. ○ Automatically request certificate: enter the domain from which to request the certificate files.
TLS Private Key	Upload private key for the built-in HTTP server. Note: The size of the key file must be under 2MB and it will be renamed as "private.pem" automatically.
TLS Cert	Upload the certificate for the built-in HTTP server and override the existing one. Note: The size of your certificate must be under 2MB. This is the certificate file (*.pem format only) for TLS connection and it will be renamed as "certificate.pem" automatically. It contains a private key for the client and a signed certificate for the server.
Reset Certificate	Restore the default key and certificate. The web server needs to reload to take effect after certificate restoration.

Network Settings

After successfully connecting the GXW450X to the network for the first time, users could log in to the Web GUI and go to System Settings→Network Settings to configure the network parameters for the device. In this section, all the available network setting options are listed. Select each tab on Web GUI→**System Settings**→**Network Settings** page to configure IPV4 Settings, IPV6 Settings, 802.1X and Static Routes.

Basic Settings

Please refer to the following tables for basic network configuration parameters on GXW450X.

Method	Switch: WAN port interface will be used for the uplink connection. LAN port interface be used as a room for PC connection.
MTU	Specifies the Maximum Transmission Unit. (By default, it's 1492)
IPv4 Address	
Preferred DNS Server	Enter the preferred DNS server address. If Preferred DNS is used, GXW450X will try to as the Primary DNS server.
WAN (when Method set to "Route") / LAN (when Method set to "Switch")	
IP Method	Select DHCP, Static IP, or PPPoE. The default setting is DHCP.
If "IP Method" is set to "Static"	
IP Address	Enter the IP address for static IP settings. The default setting is 192.168.0.160
Subnet Mask	Enter the subnet mask address for static IP settings. The default setting is 255.255.0.0.
Gateway IP	Enter the gateway IP address for static IP settings. The default setting is 0.0.0.0

DNS Server 1	Enter the DNS server 1 address for static IP settings.
DNS Server 2	Enter the DNS server 2 address for static IP settings.
If "IP Method" is set to "PPPoE"	
User Name	Enter the user name to connect via PPPoE.
Password	Enter the password to connect via PPPoE.
If "IP Method" is set to "DHCP", "Static" or "PPPoE"	
Layer 2 QoS 802.1Q/VLAN Tag	Assign the VLAN tag of the layer 2 QoS packets for the LAN port. The default value is VLAN Tag). The valid range is between 2 and 4094.
Layer 2 QoS 802.1p Priority Value	Assign the priority value of the layer 2 QoS packets for the LAN port. The default value is The valid range is between 0 and 7.
LAN (when Method set to "Route")	
IP Address	Enter the IP address. The default setting is 192.168.2.1
Subnet Mask	Enter the subnet mask address. The default setting is 255.255.255.0.
DHCP Server Enable	Enable or disable DHCP server capability. The default setting is "Yes.
DNS Server 1	Enter DNS server address 1. The default setting is 8.8.8.8
DNS Server 2	Enter DNS server address 2. The default setting is 208.67.222.222.
Allow IP Address From	Enter the DHCP IP Pool starting address. The default setting is 192.168.2.100.
Allow IP Address To	Enter the DHCP IP Pool ending address. The default setting is 192.168.2.254.
Default Gateway	Configure the default Gateway assigned by the DHCP server.
Default IP Lease Time	Enter the IP lease time (in seconds). The default setting is 43200.
Layer 2 QoS 802.1Q/VLAN Tag	Assign the VLAN tag of the layer 2 QoS packets for the LAN port. The default value is VLAN Tag). The valid range is between 2 and 4094.
Layer 2 QoS 802.1p Priority Value	Assign the priority value of the layer 2 QoS packets for LAN port. The default value is valid range is between 0 and 7.
IPv6 Address	
WAN (when "Method" is set to "Route") / LAN (when "Method" is set to "Switch")	
IP Method	Select Auto or Static. The default setting is Auto
If "IP Method" is set to "Static"	
IP Address	Enter the IP address for static IP settings.
IP Prefixlen	Enter the Prefix length. Default is 64
DNS Server 1	Enter the DNS server 1 address for static settings.
DNS Server 2	Enter the DNS server 2 address for static settings.

LAN (when "Method" is set to "Route")	
DHCP Server	<p>Enable or disable DHCP server capability. Available options are:</p> <ul style="list-style-type: none"> ○ Disable: DHCP Server will be disabled ○ Auto: Stateless address auto-configuration using NDP protocol ○ DHCPv6: Stateful address autoconfiguration using DHCPv6 protocol. <p>The default setting is "Disable"</p>
If "DHCP Server" is set to "Auto" or "DHCPv6"	
DHCP Prefix	<p>Enter DHCP Prefix when static IP is used. Format: "xxxx:xxxx:xxxx:xxxx:xxxx:xxxx:xxxx:xxxx"</p> <p>Default is "2001:db8:2:2::"</p>
DHCP Prefixlen	<p>Enter the Prefix length. Default is 64</p>
DNS Server 1	<p>Enter DNS server address 1.</p> <p>The default setting is "2001:4860:4860::8888".</p>
DNS Server 2	<p>Enter DNS server address 2.</p> <p>The default setting is "2001:4860:4860::8844".</p>
If "DHCP Server" is set to "DHCPv6"	
Allow IP Address From	<p>Enter the DHCP IP Pool starting address. The default setting is "2001:db8:2:2::3000".</p>
Allow IP Address To	<p>Enter the DHCP IP Pool ending address. The default setting is "2001:db8:2:2::4000".</p>
Default IP Lease Time	<p>Enter the IP lease time (in seconds). The default setting is 43200.</p>

Table 7: GXW450X Network Settings → Basic Settings

DHCP Client List

This feature can bind MAC to IP address on the LAN port when GXW450x is set to "Route" mode.

When devices receive IP addresses from the GXW450X LAN port, they will be listed on the web UI under "**System Settings** → **Network Settings** → **DHCP Client List**" as shown below.

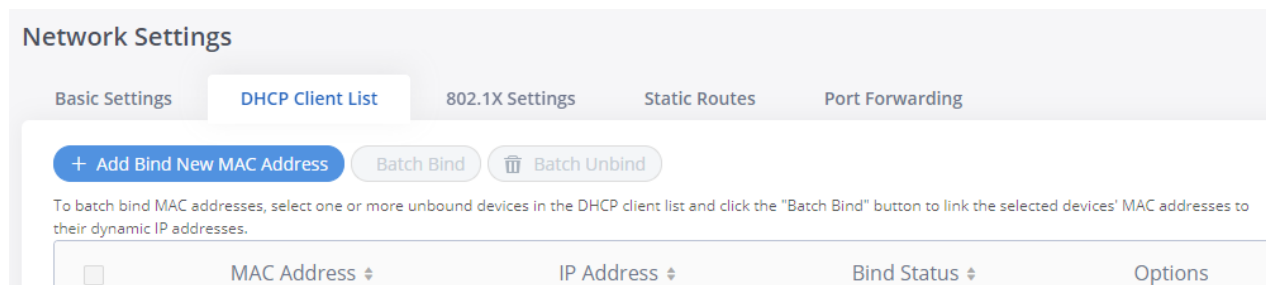

Figure 19: DHCP Client List

Users can bind manually a MAC to an IP address by clicking on **+ Add Bind New MAC Address** , the following figure will pop up.

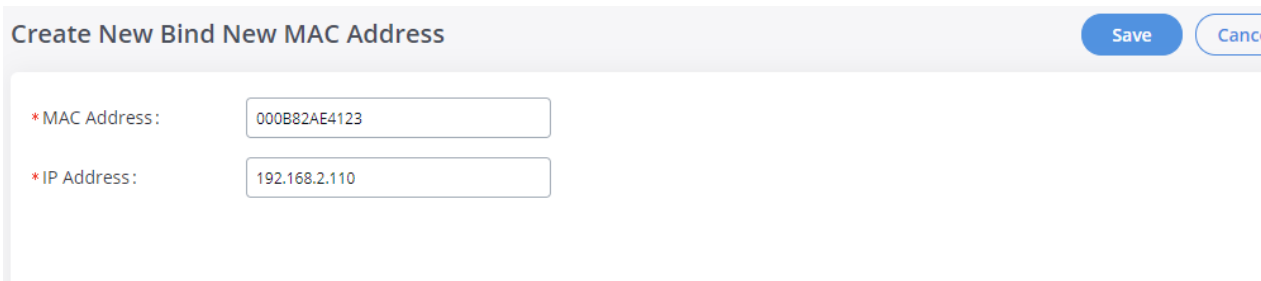

Figure 20: Add Bind New MAC Address Bind

The user needs to set the device MAC address and the IP that will be bound to it (the IP address needs to be within the GXW450X DHCP range).

In order to bind a batch of listed MAC addresses, the user needs to check first the MAC addresses to bind and click on **Batch Bind**. A confirmation popup will be shown, click **OK** to bind the addresses.

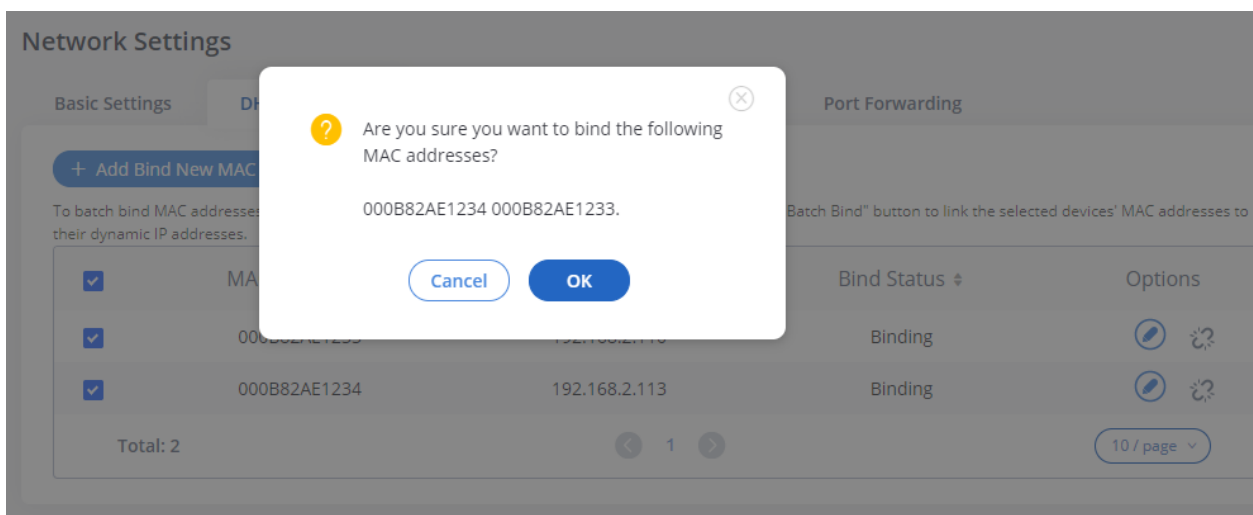

Figure 21: Batch Add MAC Address Bind

After Clicking "OK" to confirm the binding, the "Bind Status" will change from "Unbind" to "Binding".

802.1X Settings

IEEE 802.1X is an IEEE standard for port-based network access control. It provides an authentication mechanism to the device before the device can access the Internet or other LAN resources. The GXW450X supports 802.1X as a supplicant/client to be authenticated. The following diagram and show the GXW450X uses 802.1X mode "EAP-MD5" on the WAN port as the client in the network to access the Internet.

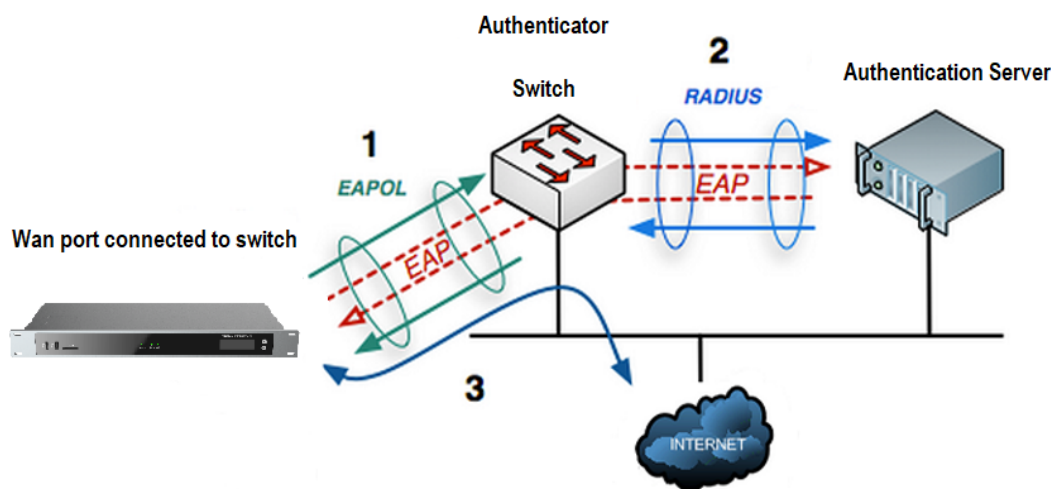

Figure 22: GXW450X Using 802.1X as Client

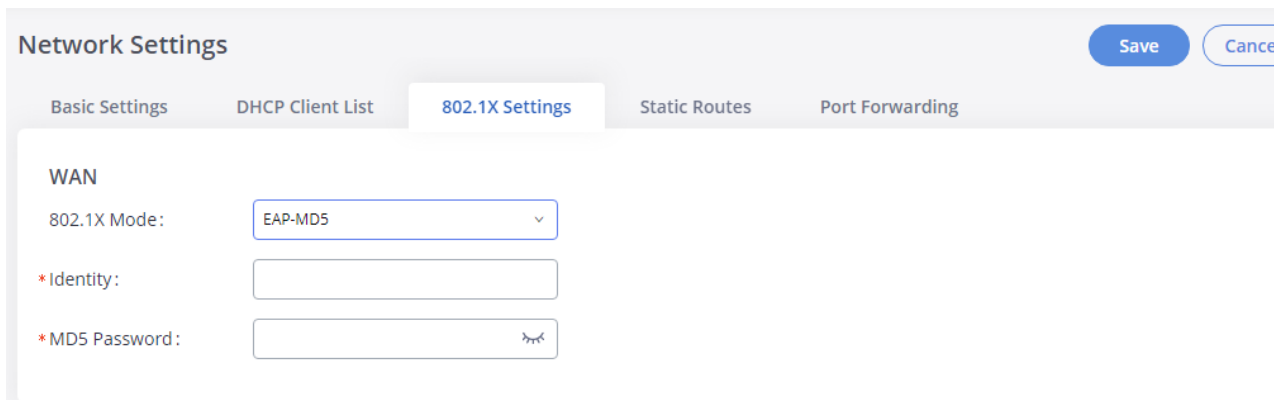

Figure 23: GXW450X using 802.1X EAP-MD5



The following table shows the configuration parameters for 802.1X on GXW450X. Identity and MD5 password are required for authentication, which should be provided by the network administrator obtained from the RADIUS server. If "EAP-TLS" or "EAP-PEAPv0/MSCHAPv2" is used as the 802.1 mode, users will also need to upload 802.1X CA Certificate and 802.1X Client Certificate, which should be also generated from the RADIUS server.

802.1X Mode	Select 802.1X mode. The default setting is "Disable". The supported 802.1X mode is: <ul style="list-style-type: none"> o EAP-MD5 o EAP-TLS o EAP-PEAPv0/MSCHAPv2
Identity	Enter 802.1X mode Identity information.
MD5 Password	Enter 802.1X mode MD5 password information.
802.1X CA Certificate	Upload 802.1X CA certificate. This file will be renamed as "8021x_ca_cert" automatically.
802.1X Client Certificate	Upload 802.1X client certificate with both certificate and private key. This file will be renamed as "8021x_client_cert" automatically.

Table 8: GXW450X Network Settings→802.1X

Static Routes

The GXW450X provides users static routing capability that allows the device to use manually configured routes, rather than information only from dynamic routing or gateway configured in the GXW450X Web GUI→**System Settings**→**Network Settings**→**Basic Settings** to forward traffic. It can be used to define a route when no other routes are available or necessary.

- o Click on **+ Add IPv4 Static Route** to create a new IPv4 static route or click on **+ Add IPv6 Static Route** to create a new IPv6 static route. configuration parameters are listed in the table below.
- o Once added, users can select  to edit the static route.
- o Select  to delete the static route.

Destination	Configure the destination IPv4 address or the destination IPv6 subnet for the GXW450X to reach using the static route. Example: IPv4 address – 192.168.66.4 IPv6 subnet – 2001:740:D::1/64
Netmask	Configure the subnet mask for the above destination address. If left blank, the default value is 255.255.255.255. Example: 255.255.255.0

Gateway	Configure the IPv4 or IPv6 gateway address so that the GXW450X can reach the destination via this gateway. The gateway address optional. Example: 192.168.40.5 or 2001:740:D::1
Interface	Specify the network interface on the GXW450X to reach the destination using the static route.

Table 9: GXW450X Network Settings → Static Routes

Port Forwarding

The GXW450X network interface supports router functions which provide users the ability to do port forwarding. If the GXW450X is set to "Route" Web GUI → **System Settings** → **Network Settings** → **Basic Settings: Method**, port forwarding is available for configuration.

The port forwarding configuration is under the Web GUI → System Settings → Network Settings → Port Forwarding page. Please see the related settings in the table below.

WAN Port	Specify the WAN port number or a range of WAN ports. An unlimited number of ports can be configured. Note: When it is set to a range, the WAN port, and LAN port must be configured with the same range, such as WAN port: 1000-1005 and LAN port: 1000-1005, and access from the WAN port will be forwarded to the LAN port with the same port number, for example, WAN port will be port forwarding to LAN port 1000.
LAN IP	Specify the LAN IP address.
LAN Port	Specify the LAN port number or a range of LAN ports. Note: When it is set to a range, the WAN port, and LAN port must be configured with the same range, such as WAN port: 1000-1005 and LAN port: 1000-1005, and access from the WAN port will be forwarded to the LAN port with the same port number, for example, WAN port will be port forwarding to LAN port 1000.
Protocol Type	Select protocol type "UDP Only", "TCP Only" or "TCP/UDP" for the forwarding in the selected port. The default setting is "UDP Only".

Table 10: GXW450X System Settings → Network Settings → Port Forwarding

OpenVPN®

OpenVPN® settings allow the users to configure GXW450X to use VPN features, the following table gives details about the various options in order to configure the GXW450X as OpenVPN Client.

OpenVPN® Enable	Enable / Disable the OpenVPN® feature. The default is "Disabled".
Configuration Method	Select the OpenVPN® configuration method. <ul style="list-style-type: none"> ○ Manual Configuration. ○ Upload Configuration File.
If "Configuration Method" is set to "Manual Configuration"	
OpenVPN® Server Address	Configures the hostname/IP and port of the server. For example, "192.168.1.2:22" or "2001:0DB8:0000:0000:0000:0000:1428:0000".

OpenVPN® Server Protocol	<p>Select the same protocol that the OpenVPN® server is using, e.g., select UDP if the OpenVPN® server is using UDP. Available options:</p> <ul style="list-style-type: none"> ○ UDP ○ TCP <p>The default setting is "UDP".</p>
OpenVPN® Device Mode	<p>Use the same setting as used on the server.</p> <ul style="list-style-type: none"> ○ Dev TUN: Create a routed IP tunnel. ○ Dev TAP: Create an Ethernet tunnel. <p>The default setting is "Dev TUN".</p>
OpenVPN® Use Compression	<p>Compress tunnel packets using the LZO algorithm on the VPN link. Don't enable this unless it is enabled in the server config file.</p>
OpenVPN® Encryption Algorithm	<p>Please select a cryptographic cipher from the drop-down list. Use the same setting that you are using on the server. The default setting is "BF-CBC(Blowfish)".</p>
OpenVPN® CA Cert	<p>Upload an SSL/TLS root certificate. This file will be renamed as 'ca.crt' automatically.</p>
OpenVPN® Client Cert	<p>Upload a client certificate. This file will be renamed as 'client.crt' automatically.</p>
OpenVPN® Client Key	<p>Upload a client private key. This file will be renamed as 'client.key' automatically.</p>
User Authentication	<p>Enables the authentication by entering the Username and Password credentials , Disabled by Default.</p>
If "Configuration Method" is set to "Manual Configuration"	
OpenVPN® Configuration File	<p>Upload Configuration file to with OpenVPN® settings.</p> <p>Only file with .conf.ovpn suffix is accepted for OpenVPN® Configuration File. The file size must be under 2MB.</p>

Table 11: GXW450X System Settings → Network Settings → OpenVPN®

OpenVPN®

OpenVPN® Enable:

Configuration Method: Manual Configuration

* OpenVPN® Server

Address:

OpenVPN® Server Protocol: UDP

OpenVPN® Device mode: Dev TUN

OpenVPN® Use Compression:

OpenVPN® Encryption Algorithm: BF-CBC(Blowfish)

OpenVPN® CA Cert: Choose File to Upload Delete

OpenVPN® Client Cert: Choose File to Upload Delete

OpenVPN® Client Key: Choose File to Upload Delete

© 2002-2014 OpenVPN Technologies, Inc.
OpenVPN is a registered trademark of OpenVPN Technologies, Inc.

Figure 24: OpenVPN® Feature on the GXW450X

DDNS Settings

DDNS setting allows users to access GXW450X via domain name instead of IP address.

The GXW450X supports DDNS service from the following DDNS provider:

- dydns.org
- freedns.afraid.org
- zoneedit.com
- noip.com
- oray.net

Here is an example of using noip.com for DDNS.

1. Register domain in DDNS service provider. Please note the GXW450X needs to have public IP access.

Hostname ⓘ

gxwtest

Domain ⓘ

ddns.net

Record Type

DNS Host (A) ⓘ

AAAA (IPv6) ⓘ

DNS Alias (CNAME) ⓘ

Web Redirect ⓘ

[Manage](#) your Round Robin, TXT, SRV and DKIM records.

Wildcard ⓘ

[Upgrade to Enhanced](#)
to enable wildcard hostnames.

MX Records

[+ Add MX Records](#)

Figure 25: Register Domain Name on Noip.com

2. On Web GUI→**System Settings**→**Network Settings**→**DDNS Settings**, enable DDNS service and configure username, password, and hostnar

DDNS Settings Save Cancel

DDNS Server: no-ip.com

Enable DDNS:

* Username: gshztest

* Password:

* Host Name: gxwtest.ddns.net

Figure 26: GXW450X DDNS Settings

3. Now you can use a domain name instead of an IP address to connect to the GXW450X Web GUI.

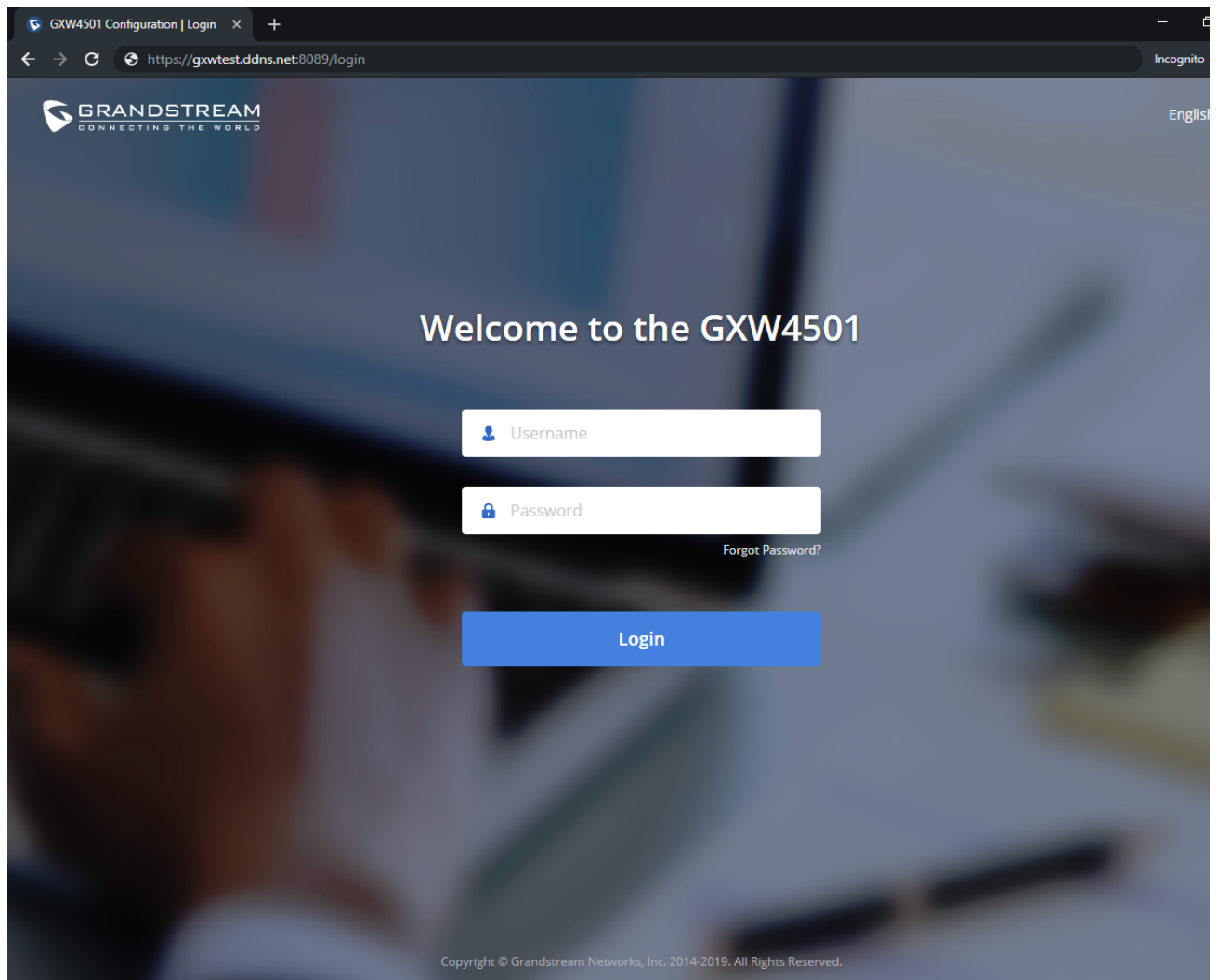

Figure 27: Using Domaine Name to Connect to GXW450X

Security Settings

The GXW450X provides users with firewall security configurations to prevent certain malicious attacks on the GXW450X system. Users could configure to allow, restrict or reject specific traffic through the device for security and bandwidth purpose. The GXW450X also provides the Fail2ban feature for authentication errors in SIP REGISTER, INVITE and SUBSCRIBE. To configure firewall settings in the GXW450X, go to the Web GUI → **System Settings** → **Security Settings** page.

Static Defense

Under the Web GUI → **System Settings** → **Security Settings** → **Static Defense** page, users will see the following information:

- Current service information with port, process, and type.
- Custom firewall settings.
- Typical firewall settings.

The following table shows a sample current service status running on the GXW450X.

Port	Process	Type	Port	Process	Type
2000	asterisk	TCP/IPv4	67	dhcpcd	UDP/IPv4
8088	asterisk	TCP/IPv4	69	udpsvd	UDP/IPv4
8888	pbxmid	TCP/IPv4	37178	asterisk	UDP/IPv4
25	master	TCP/IPv4	80	lighttpd	TCP/IPv6
7777	asterisk	TCP/IPv4		master	TCP/IPv6

Port	Process	Type	Port	Process	Type
7681	pbxmid	TCP/IPv4	8089	lighttpd	TCP/IPv6
4520	asterisk	UDP/IPv4	4569	asterisk	UDP/IPv6
4569	asterisk	UDP/IPv4	5060	asterisk	UDP/IPv6
3765	dhcpcd	UDP/IPv4	24539	dhcpcd	UDP/IPv6
5000	asterisk	UDP/IPv4	54411	asterisk	UDP/IPv6
67	udhcpd	UDP/IPv4			

Table 12: GXW450X Static Defense → Current Service

Under "Custom Firewall Settings", users could create new rules to accept, reject or drop certain traffic going through the GXW450X. To create a new rule, click on the "Create New Rule" button and a new window will pop up for users to specify rule options.

Right next to the "Create New Rule" button, there is a checkbox for the option "Reject Rules". If it's checked, all the rules will be rejected except the firewall rules listed below. In the firewall rules, only when there is a rule that meets all the following requirements, the option "Reject Rules" will be allowed to check:

- Action: "Accept"
- Type "In"
- The destination port is set to the system login port (e.g., by default 8089)
- The protocol is not UDP

The screenshot shows a 'Create New Firewall Rule' dialog box with the following configuration:

- * Rule Name:** Rejection_Rule
- * Action:** Accept
- * Type:** IN
- * Interface:** (empty)
- * Service:** Custom
- Source IP Address and Port:** Anywhere : Any
- Destination IP Address and Port:** Anywhere : 8089
- * Protocol:** TCP

Figure 28: Create New Firewall Rule







Below is a table listing all the firewall rules settings:

Rule Name	Specify the Firewall rule name to identify the firewall rule.
Action	Select the action for the Firewall to perform. 1. ACCEPT 2. REJECT 3. DROP
Type	Select the traffic type.

	<ul style="list-style-type: none"> • IN : If selected, users will need to specify to the network interface (for GXW450X) for the incoming traffic, the network interface can be set to “WAN”, “LAN”, or Both. • OUT
Service	<p>Select the service type.</p> <ol style="list-style-type: none"> 1. FTP 2. SSH 3. Telnet 4. HTTP 5. Custom <p>If “Custom” is selected, users will need to specify Source (IP and port), Destination (IP and port), and Protocol (TCP, UDP, or Both) for the service. Please note if source or the destination field is left blank, it will be used as “Anywhere”.</p>

Table 13: Firewall Rule Settings

Save the change and click on the “Apply” button. Then submit the configuration by clicking on “Apply Changes” on the upper right of the web page. A new rule will be listed at the bottom of the page with sequence number, rule name, action, protocol, type, source, destination, and operation. More operations are below:

- Click on  to edit the rule.
- Click on  to delete the rule.
- Use the arrows up , down , to the top  or to the bottom  to move the rules up and down.

For typical firewall settings, users could configure the following options on the GXW450X.

Ping Defense Enable	If enabled, ICMP response will not be allowed for Ping requests. The default setting is disabled. To enable or disable it, click the check box for the LAN or WAN (GXW450X) interface.
SYN-Flood Defense Enable	<p>Allows the GXW450X to handle excessive amounts of SYN packets from one source and keep the web portal access. There are two options available and only one of these options may be enabled at one time.</p> <ul style="list-style-type: none"> ◦ eth(0)LAN defends against attacks directed to the LAN IP address of the GXW450X. ◦ eth(1)WAN defends against attacks directed to the WAN IP address of the GXW450X. <p>SYN Flood Defense will limit the number of SYN packets accepted by the GXW450X from one source to 10 packets per second. Any excess packets from that source will be discarded.</p>
Ping-of-Death Defense Enable	Enable to prevent Ping-of-Death attack on the device. The default setting is disabled. To enable or disable it, click on the check box for the LAN or WAN (GXW450X) interface.

Table 14: Typical Firewall Settings

Dynamic Defense

Dynamic defense is supported on the GXW450X series. It can blacklist hosts dynamically when the LAN mode is set to “Route” under the Web GUI → System Settings → Network Settings → Basic Settings page. If enabled, the traffic coming into the GXW450X can be monitored, which helps prevent massive connection attempts or brute force attacks on the device. The blacklist can be created and updated by the GXW450X firewall, which will be displayed on the web page. Please refer to the following table for dynamic defense options on the GXW450X.

Dynamic Defense Enable	Enable dynamic defense. The default setting is disabled.
Blacklist Update Interval	Configure the blacklist update time interval (in seconds). The default setting is 120.
Connection Threshold	Configure the connection threshold. Once the number of connections from the same host reaches the threshold, it will be added to the blacklist. The default setting is 100.

Dynamic Defense Whitelist	Allowed IPs and ports range, multiple IP addresses, and port range. For example: 192.168.2.10- 192.168.2.20 5060:5061
Blacklist	
Black List	Users will be able to view the IPs that have been blocked by GXW450X.

Table 15: GXW450X Firewall Dynamic Defense

The following figure shows a configuration example:

- o If a host at IP address 192.168.2.5 initiates more than 100 TCP connections to the GXW450X, it will be added to the GXW450X blacklist. This host 192.168.2.5 will be blocked by the GXW450X for 500 seconds.
- o Since IP range 192.168.2.10-192.168.2.20 is in the whitelist, if a host initiates more than 20 TCP connections to the GXW450X within 1 minute, not be added to the GXW450X blacklist. It can still establish a TCP connection with the GXW450X.

The screenshot shows the 'Security Settings' page with the 'Dynamic Defense' tab selected. A 'Save' button is visible in the top right corner. The 'Dynamic Defense' section includes a 'Dynamic Defense Enable' checkbox which is checked. Below it are two input fields: '*Blacklist Update Interval (s):' with the value '120' and '*Connection Threshold:' with the value '100'. There is also a 'Dynamic Defense Whitelist' text area which is currently empty. Below this section is a 'Blacklist' table with two columns: 'IP' and 'Operation'. The table is currently empty, displaying 'No Data'.

Figure 29: Dynamic Defense Configuration

Fail2Ban

Fail2Ban feature on the GXW450X provides intrusion detection and prevention for authentication errors in SIP INVITE and SUBSCRIBE. Once the error is detected within "Max Retry Duration", the GXW450X will act to forbid the host for a certain period as defined in "Banned Duration". This feature helps prevent SIP brute force attacks on the gateway system.

Security Settings
Save

Static Defense
Dynamic Defense
Fail2ban
TLS Security
SSH Access

Global Settings

Enable Fail2Ban:

*Banned Duration:

*Max Retry Duration:

*MaxRetry:

Fail2ban Whitelist: +

Local Settings

Asterisk Service:

Login Attack Defense:

Blacklist

Banned Type	IP	Operation

Figure 30: Fail2Ban Settings

Global Settings	
Enable Fail2Ban	Enable Fail2Ban. The default setting is disabled. Please make sure both "Enable Fail2Ban" and "Asterisk Service" are turned on to Fail2Ban for SIP authentication on the GXW450X.
Banned Duration	Configure the duration (in seconds) for the detected host to be banned. The default setting is 600. If set to 0, the host will be always banned.
Max Retry Duration	Within this duration (in seconds), if a host exceeds the max times of retry as defined in "MaxRetry", the host will be banned. The default setting is 600.
MaxRetry	Configure the number of authentication failures during "Max Retry Duration" before the host is banned. The default setting is 5.
Fail2Ban Whitelist	Configure IP address, CIDR mask, or DNS host in the whitelist. Fail2Ban will not ban the host with a matching address in this list. 20 addresses can be added to the list.
Local Settings	
Asterisk Service	Enable Asterisk service for Fail2Ban. The default setting is disabled. Please make sure both "Enable Fail2Ban" and "Asterisk Service" are turned on to use Fail2Ban for SIP authentication on the GXW450X.
Listening Port Number	Configure the listening port number for the service. By default, port 5060 will be used for UDP and TCP, and port 5061 will be used for TLS.
MaxRetry	Configure the number of authentication failures during "Max Retry Duration" before the host is banned. The default setting is 10. Please make sure this option is properly configured as it will override the "MaxRetry" value under "Global Settings".
Login Attack Defense	Enables defense against excessive login attacks to the GXW450X's web GUI. The default setting is disabled.
Listening Port Number	This is the Web GUI listening port number which is configured under System Settings → HTTP Server → Port . The default is 8080.
MaxRetry	When the number of failed login attempts from an IP address exceeds the MaxRetry number, that IP address will be banned from accessing the Web GUI. The default setting is 5.
Blacklist	

Black List	Users will be able to view the IPs that have been blocked by GXW450X.
-------------------	---

Table 16: Fail2Ban Settings

TLS Security

Under the Web **GUI→System Settings→Security Settings→TLS security** page, users can now select the minimum and maximum versions of TLS GXW450x to support.

Maximum TLS Version	Specifies the minimum TLS version on the GXW450x in order to accept TLS connection.
Minimum TLS Version	Specifies the maximum TLS version on the GXW450x in order to accept TLS connection.

Table 17: TLS Security parameters

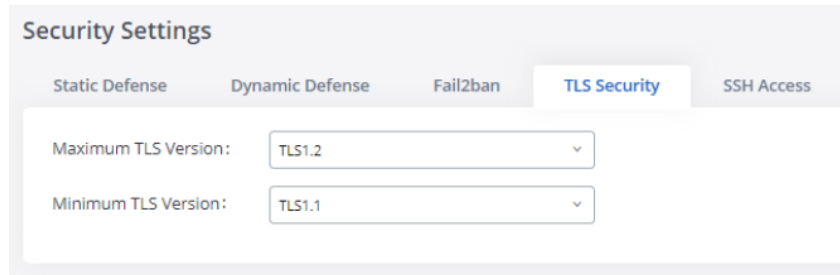

Figure 31: TLS Security

SSH Access

SSH switch is available via Web GUI. Users can enable or disable SSH access directly from the Web GUI or LCD screen. For web SSH access, please GXW450X web interface and go to Web GUI→**System Settings→Security Settings→SSH Access**. By default, SSH access is disabled for security concerns. It is highly recommended to only enable SSH access for debugging purposes

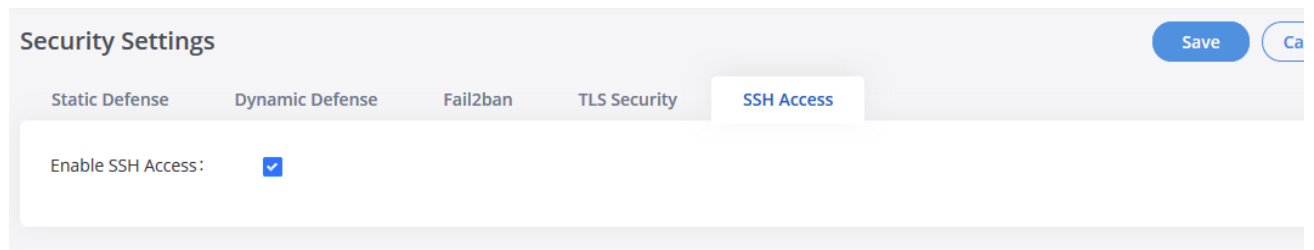

Figure 32: SSH Access

Time Settings

Automatic Date and Time

The current system time on the GXW450X can be found under Web GUI→**System Status→Dashboard→PBX Status**.

To configure the GXW450X to update the time automatically, go to Web GUI→**System Settings→Time Settings→Automatic Date and Time**.

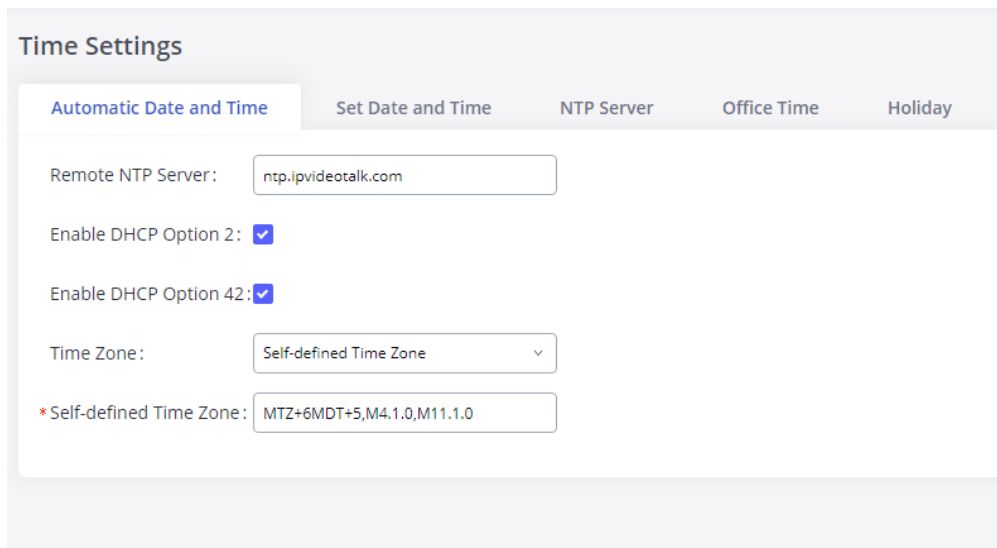

Figure 33: Automatic Date and Time Settings

The configurations under Web GUI→Settings→Time Settings→Automatic Date and Time page require reboot to take effect. Please consider configuring Automatic Date and Time-related changes when setting up the GXW450X for the first time to avoid service interruption after installation and deployment production.

Remote NTP Server	Specify the URL or IP address of the NTP server for the GXW450X to synchronize the date and time. The default NTP server is ntp.ipvideotalk.com.
Enable DHCP Option 2	If set to "Yes", the GXW450X can get provisioned for Time Zone from DHCP Option 2 in the local server automatically. The default setting is "Yes".
Enable DHCP Option 42	If set to "Yes", the GXW450X can get provisioned for NTP Server from DHCP Option 42 in the local server automatically. This will override the manually configured NTP Server. The default setting is "Yes".
Time Zone	Select the proper time zone option so the GXW450X can display the correct time accordingly. If "Self-Defined Time Zone" is selected, please specify the time zone parameters in the "Self-Defined Time Zone" field as described below option.
Self-Defined Time Zone	If "Self-Defined Time Zone" is selected in the "Time Zone" option, users will need to define their own time zone following the format below. The syntax is: std offset dst [offset], start [/time], end [/time] Default is set to: MTZ+6MDT+5,M4.1.0,M11.1.0 MTZ+6MDT+5 This indicates a time zone with 6 hours offset and 1 hour ahead for DST, which is U.S. central time. If it is positive (+), the local time zone is west of the Prime Meridian (A.K.A: International or Greenwich Meridian); If it is negative (-), the local time zone is east. M4.1.0,M11.1.0 The 1st number indicates Month: 1,2,3..., 12 (for Jan, Feb, ..., Dec). The 2nd number indicates the nth iteration of the weekday: (1st Sunday, 3rd Tuesday...). Normally 1, 2, 3, 4 are used. If 5 is used, it means the last iteration of the weekday. The 3rd number indicates weekday: 0,1,2,...,6 (for Sun, Mon, Tues, ... ,Sat). Therefore, this example is the DST which starts on the First Sunday of April to the 1st Sunday of November.

Table 18: Automatic Date and Time Settings

Set Date and Time

To manually set the time on the GXW450X, go to Web GUI→**System Settings**→**Time Settings**→**Set Date and Time**. The format is YYYY-MM-DD HH:MM:SS.

The screenshot shows the 'Time Settings' page with the 'Set Date and Time' tab selected. The 'Current Date and Time' field is empty with a calendar icon. The 'Date Format' dropdown is set to 'yyyy-mm-dd'. The 'Time Format' dropdown is set to 'Use 24-hour F...'. Other tabs include 'Automatic Date and Time', 'NTP Server', 'Office Time', and 'Holiday'.

Figure 34: Date and Time Manual Configuration

Current Date and Time	Manually set up the system time. If the system time is automatically set up successfully, the manually configured value will not take effect.
Date Format	Configure the global date format, the default format is yyyy-mm-dd.
Time Format	Chooses the format that will be used to display the Time, 24-hour format or 12-hour format, the default setting is the 24-hour format.

Table 19: Date and Time Manual Settings

Manual setup of time will take effect immediately after saving and applying changes in the Web GUI. If users would like to reboot the GXW450X and keep manual setup time setting, please make sure "Remote NTP Server", "Enable DHCP Option 2" and "Enable DHCP Option 42" options under Web GUI→Settings→Time Settings→ Automatic Date and Time page are unchecked or set to empty. Otherwise, time auto updating settings in this page will take effect after reboot.

NTP Server

The GXW450X can be used as an NTP server for the NTP clients to synchronize their time. To configure the GXW450X as the NTP server, set "Enable NTP Server" to "Yes" under Web GUI→**System Settings**→**Time Settings**→**NTP Server**. On the client side, point the NTP server address to the GXW450X address or hostname to use the GXW450X as the NTP server.

The screenshot shows the 'Time Settings' page with the 'NTP Server' tab selected. The 'Enable NTP Server' checkbox is checked. Other tabs include 'Automatic Date and Time', 'Set Date and Time', 'Office Time', and 'Holiday'.

Figure 35: GXW450X NTP Server

Office Time

On the GXW450X, the system administrator can define "office time", which can be used to configure time conditions for the inbound rule schedule. To configure office time, go to Web GUI→**System Settings**→**Time Settings**→**Office Time**. Click on "Add Office Time" to create an office time.

Create New Office Time

Time: -

Week: Sun Mon Tue Wed
 Thu Fri Sat
 All

Show Advanced Options:

Month: Jan Feb Mar Apr
 May Jun Jul Aug
 Sept Oct Nov Dec
 All

Day: 1 2 3 4
 5 6 7 8
 9 10 11 12
 13 14 15 16
 17 18 19 20
 21 22 23 24
 25 26 27 28
 29 30 31
 All

Figure 36: Add New Office Time

Time	Configure the start time and end time for office hours.
Week	Select the work days in one week.
Show Advanced Options	Check this option to show advanced options. Once selected, please specify the "Month" and "Day" options.
Month	Select the months for office time.
Day	Select the work days in one month.

Table 20: Office Time Settings

Select "Time" and the day for the "Week" for the office time. The system administrator can also define the month and day of the month as advanced options. Once done, click on "Save" and then "Apply Change" for the office time to take effect. The office time will be listed on the web page as the figure shows below.

Time Settings

Automatic Date and Time Set Date and Time NTP Server **Office Time** Holiday

[+ Add Office Time](#) [Delete Selected Office Times](#)

<input type="checkbox"/>	Index	Time	Week	Month	Day	Options
<input type="checkbox"/>	1	09:00-18:59	Mon Tue Wed Thu Fri	Default	Default	✎ 🗑️

Total: 1 < 1 > 10 / page v

Figure 37: Time Settings → Office Time

- Click on [✎](#) to edit the office time.
- Click on [🗑️](#) to delete the office time.
- Click on "Delete Selected Office Times" to delete multiple selected office times at once.

Holiday

On the GXW450X, the system administrator can define "holiday", which can be used to configure time conditions for the inbound rule schedule. To configure holiday, go to Web GUI→System Settings→Time Settings→Holiday. Click on "Add Holiday" to create holiday time.

Create New Holiday

*Name:

Holiday Memo:

Month: Jan Feb Mar Apr May Jun
 Jul Aug Sept Oct Nov Dec
 All

Day: 1 2 3 4 5 6
 7 8 9 10 11 12
 13 14 15 16 17 18
 19 20 21 22 23 24
 25 26 27 28 29 30
 31
 All

Show Advanced Options:

Week: Sun Mon Tue Wed Thu Fri
 Sat
 All

Figure 38: Add a Holiday

Name	Specify the holiday name to identify this holiday.
Holiday Memo	Create a note for the holiday.
Month	Select the month for the holiday.
Day	Select the day for the holiday.
Show Advanced Options	Check this option to show advanced options. If selected, please specify the days as holidays in one week below.
Week	Select the days as holidays in one week.

Table 21: Holiday Settings

Enter holiday "Name" and "Holiday Memo" for the new holiday. Then select "Month" and "Day". The system administrator can also define days in week as advanced options. Once done, click on "Save" and then "Apply Change" for the holiday to take effect. The holiday will be listed in the web as the figure shows below.

Time Settings

Automatic Date and Time Set Date and Time NTP Server Office Time **Holiday**

[+ Add Holiday](#) [Delete Selected Holidays](#)

<input type="checkbox"/>	Name	Week	Month	Day	Holiday Memo	Options
<input type="checkbox"/>	National Holidays	Fri	Jan	11	independence manifesto	Edit Delete

Total: 1 < 1 > 10 / page

Figure 39: Time Settings→Holiday

- o Click on to edit the holiday.

- Click on  to delete the holiday.
- Click on "Delete Selected Holidays " to delete multiple selected holidays at once.

Email Settings

Email Settings

The Email application on the GXW450X can be used to send out alert event Emails, retrieve admin password, etc. The configuration parameters can be accessed via Web GUI→**System Settings**→**Email Settings**→**Email Settings**.

TLS Enable	Enable or disable TLS during transferring/submitting your Email to another SMTP server. The default setting is "Yes".
Type	Select Email type. <ul style="list-style-type: none"> ○ MTA: Mail Transfer Agent. The Email will be sent from the configured domain. When MTA is selected, there is no need to set up SMTP server for it, or no user login is required. However, the Emails sent from MTA might be considered spam by the target SMTP server. ○ Client: Submit Emails to the SMTP server. An SMTP server is required, and users need log in with the correct credentials.
Email Template Sending	Select the email template format to be sent. The "HTML" format is compatible with most mail clients and is recommended. If the mail client does not support the "HTML" format, please select the "Plain Text" format.
Domain	Specify the domain name to be used in the Email when using the type "MTA".
SMTP Server	Specify the SMTP server when using the type "Client".
Enable SASL Authentication	Enable SASL Authentication. When disabled, GXW450X will not try to use the user name and password for mail client login authentication. Most of the mail server requires login authentication while some other private mail servers allow anonymous login which requires disabling this option to send Email as normal. For Exchange Server, please disable this option.
Username	A username is required when using the type "Client". Normally it's the Email address.
Password	Password to login for the above Username (Email address) is required when using the type "Client".
POP/POP3 Server Address	Configure the POP/POP3 server address for the configured username Example: pop.gmail.com
POP/POP3 Server Port	Configure the POP/POP3 server port for the configured username Example: 995
Display Name	Specify the display name in the FROM header in the Email.
Sender	Specify the sender's Email address. For example pbx@example.mycompany.com.

Table 22: Email Settings

The following figure shows a sample Email setting on the GXW450X, assuming the email is using the default SMTP server of Gmail.

Figure 40: Email Settings



Once the configuration is finished, click on "Test". In the prompt, fill in a valid Email address to send a test Email to verify the Email settings on the GXW450X.

Email Template

The Email templates on the GXW450X can be used for email notification. The configuration parameters can be accessed via Web GUI→**System Settings**→**Email Settings**→**Email Templates**.

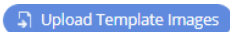
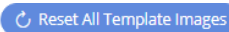

Figure 41: Email Templates

- Press on  to upload pictures to be used on email templates.
- Press  to reset all email templates to default ones.
- To configure the email template, click the  button under Options column, and edit the template as desired.

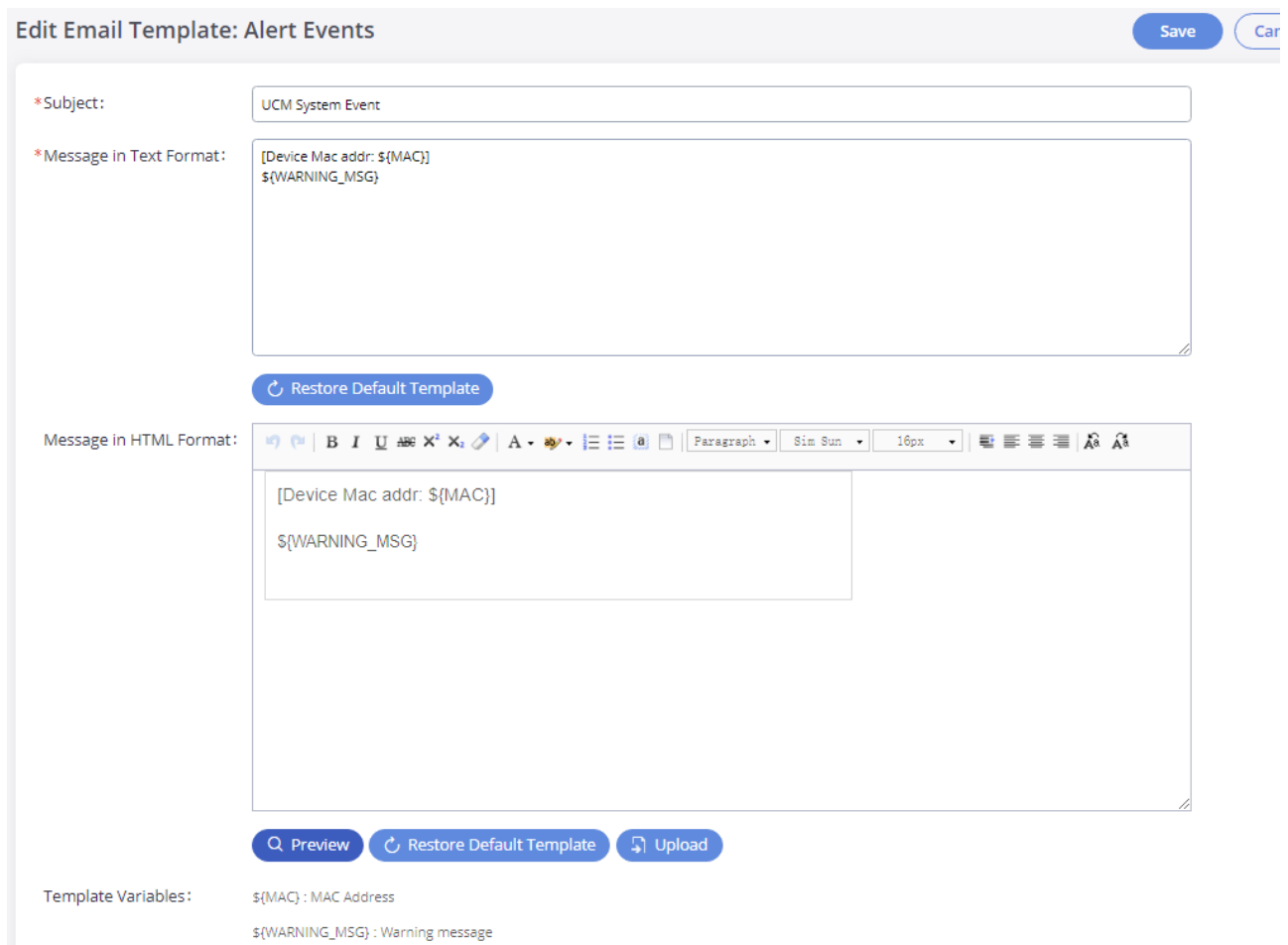

Figure 42: Alert Events Template

- Users can preview mail sample by clicking on [Preview](#) .
- Click on [Restore Default Template](#) in order to restore the default email template.
- Finally, users can click on [Upload](#) to upload a custom picture to the email template to display their own logo in the sent mails for example.

Email Send Log

Under GXW450X Web GUI→**System Settings**→**Email Settings**→**Email Send Log**, users could search, filter, and check whether the Email is sent or not. This page will also display the corresponding error message if the Email is not sent out successfully.

Email Settings

Email Settings

Email Template

Email Send Log

In MTA mode, you cannot receive SPF authentication. Therefore, even if mail is sent successfully, the return code of 550 will still be returned. Many mail servers will place non-SPF-certified mail into the trash or quarantine mailbox. If the recipient has not received sent mail, please check to see if the sent mail was placed in the recipient's trash or quarantine mailbox.

In Client mode, a 250 return code means that the Email has been sent successfully from the GXW to your proxy mail server. The Email still fails to be sent due to invalid destination address or other reasons. Please login in your configuration mail account and check whether there is System bounce notification to confirm the cause of the failure. [Return Code](#)

250 Mail sent successfully.

501 Address format parsing error. In MTA mode, if the recipient's email address contains unsupported characters, a 501 message will be returned. Please check if the format of the recipient's email address is correct. In Client mode, some servers also return 501 when the sender and mail accounts do not match. Please correct "Sender" for your "Mail Account".

535 There was a problem with account/password verification in client mode. Please check that "account and password" are configured correctly (individual email servers will return 460).

550 Possible Causes: (1)The recipient's email address does not exist or is in a disabled state. Please check the recipient's email address for errors.

(2)The number of destination addresses sent by the sender exceeds the maximum daily limit and is temporarily blacklisted. Please decrease the sending frequency or try again the next day.

(3)The sending IP does not pass the SPF permission detection of the sending domain. Messages sent in MTA mode may still return the error code even if they are sent successfully.

552 The message size is too large, or the message attachment type is disabled.

553 Sender and mail account inconsistencies. Please configure the "Sender" for your "Mail Account".

554 The message is identified as spam. Please decrease the sending frequency or retry the next day.

none Means no return code. If the "sending result" is deferred, there may be a problem with the mail server configuration, please check to see if the "server" configuration is correct. If the result is bounced, there may be a problem with the domain name of the recipient's email address. Please check the message's "recipient" to make sure it is correct. If in MTA mode, please make sure that "Domain" is configured to be in the same domain as the recipient.

Show All Logs

Delete All Logs

Filter

Start Time:	<input type="text" value="Please select time"/>	End Time:	<input type="text" value="Please select time"/>
Receivers:	<input type="text"/>	Send Result:	<input type="text"/>
Return Code:	<input type="text"/>	Email Send Module:	<input type="text" value="All Modules"/>
<input type="button" value="Reset"/>		<input type="button" value="Search"/>	

Email Generated Time	Email Send Module	Receivers	Last Send Time	Last Send Address	Send Result	Return Code	Options
No Data							

Figure 43: Email Send Log

Field	Description
Start Time	Enter the start time for the filter
End time	Enter the end time for the filter
Receivers	Enter the email recipient, while searching for multiple recipients, please separate them with a comma and no spaces.
Send result	Enter the status of the send result to filter with
Return code	Enter the email code to filter with
Email send module	Select the email module to filter from the drop-down list, which contains: All modules; User password; Alert events; CDR;

Table 23: Email Log Filter

SNMP

GXW450x supports SNMP (Simple Network Management Protocol) which is widely used in network management for network monitoring for collected information about monitored devices. To configure SNMP settings, go to GXW450x Web GUI → System Settings → SNMP.

Note

The SNMP page can be viewed by the Administrator level users.

Figure 44: SNMP Settings

This page has five tabs: SNMP Settings, SNMP Community, SNMP Trap Destination, SNMP V3 Users, and SNMP Trap Proxy. Please refer to the below tables for each tab.

SNMP Settings	
Enable	Enables SNMP feature. Default is Disabled .
Device Name	Configures the Device Name.
Device Location	Configures the Device Location.
Contact Email	Configures the email address of the administrator on which to receive notifications.
Enable SNMP Trap Proxy	Enables the SNMP Trap Proxy. Default is Disabled .
SNMP Trap Proxy Listening Port	Configures the SNMP Trap Proxy Listening Port. The default port is 162 .
SNMP Community	
Name	Community string associated with the trap. It must match the community string of the receiver.
Access Level	Configure the access level. Two levels are available: Read only: Can view the device configuration. Read/Write: Can view and change the device configuration.
SNMP Trap Destinations (GXW450x as managed device)	
Name	Configure the Name for the SNMP Trap Destination.

IP Address	The IP address of the SNMP trap receiver.
Port	Configure the SNMP trap receiver listening port.
Community	Community is by default set to Public, as community strings for SNMP v1 and v2 aren't encrypted.
Type	They are 3 available types: Trapsink: to send SNMP v1 traps Trap2sink: to send SNMP v2 traps. Informsink: to send inform notification.
SNMP V3 Users	
Name	Configure the Name of the SNMP v3 Users.
Authentication Protocol	Authentication Protocol for SNMPv3. Available protocols are MD5 and SHA.
Authentication Password	Authentication Password for SNMPv3.
Privacy Protocol	Privacy protocol for SNMPv3. Available protocols are: DES, AES-128, AES-192, AES-256
Privacy Password	Privacy password for SNMPv3.
Group Level	Configure the group level, two levels are available: Read only: Can view the device configuration. Read/Write: Can view and change the device configuration.
SNMP Trap Proxy (GXW450x as Trap Proxy)	
Name	Configures the Name of the SNMP Trap Proxy. Note: "Enable SNMP Trap Proxy" needs to be toggled on.
IP Address	Configure the IP address of the SNMP manager.
Port	Configure the SNMP manager listening port.

Table 24: SNMP Parameters

TR-069

The GXW450x series supports TR-069 for remote management of equipment by service providers, reducing on-site visits and downtime. To configure SNMP settings, go to GXW450x Web **GUI** → **System Settings** → **SNMP**.

Note

The SNMP page can be viewed by the Administrator level users.

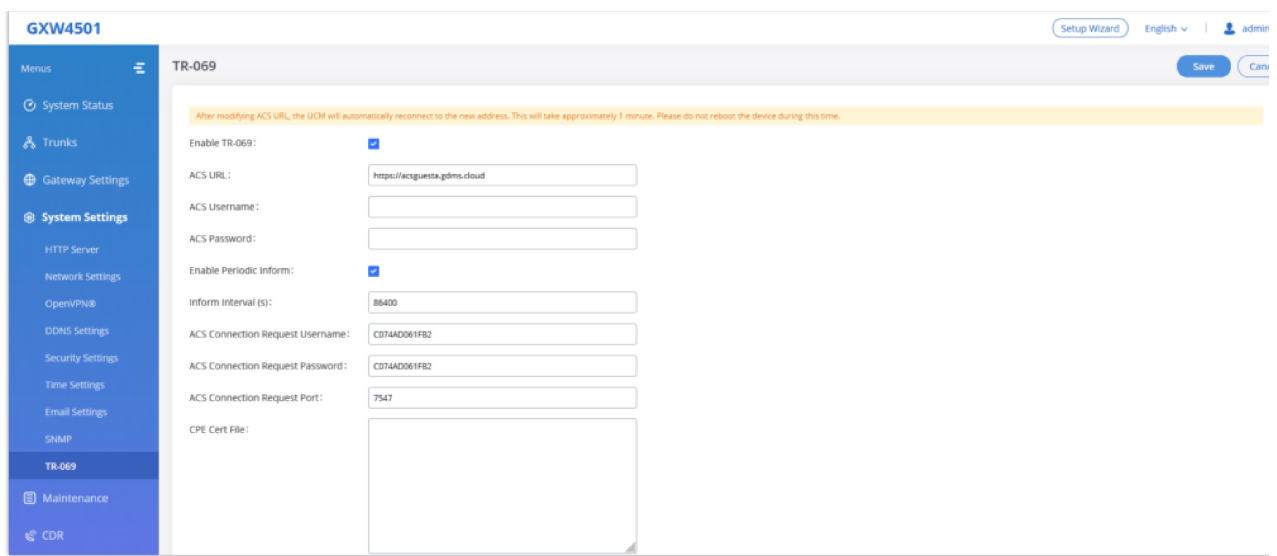

Figure 45: TR-069 Settings

Enable TR-069	Sets the device to enable the “CPE WAN Management Protocol” (TR-069). The default setting is “No”. Note: Reboot the device to make changes take effect.
ACS URL	Specifies URL of TR-069 ACS (e.g, https://acsguesta.gdms.cloud), or IP address.
ACS Username	Enters username to authenticate to ACS.
ACS Password	Enters password to authenticate to ACS.
Enable Periodic Inform	Sends periodic inform packets to ACS. The default is “No”.
Inform Interval (s)	Configures to send periodic “Inform” packets to ACS based on a specified intervals. The default setting is 86400.
ACS Connection Request Username	Enters username for the ACS to connect to the device.
ACS Connection Request Password	Enters the password for the ACS to connect to the device.
ACS Connection Request Port	Enters the port for the ACS to connect to the device.
CPE Cert File	Uploads Cert File for the device to connect to the ACS via SSL.
CPE Cert Key	Uploads Cert Key for the device to connect to the ACS via SSL.

Table 25 : TR-069 Settings

TRUNKS

GXW450X is a VoIP Digital Gateway that supports both trunk modes Digital and VoIP to ensure a smooth integration of digital and VoIP communi to connect the legacy telephony infrastructure made up of PRI (E1, T1, J1) to the IP network.

Digital Trunks

The GXW450X supports E1/T1/J1 which are physical connection technologies used in the digital network. T1 is the North American standard, J1 is Japan, whereas E1 is the European standard. GXW450X supports four signaling protocols: PRI_NET, PRI_CPE, MFC/R2, and SS7. PRI provides a vary number of channels depending on the standards in the country of implementation (E1, T1, or J1); MFC/R2 is a signaling protocol heavily used ove trunks; SS7 uses out-of-band signaling, which travels on a separate, dedicated channel rather than within the same channel as the telephone call, providing more efficiency and higher security level when the telephone calls are set up.

To set up a digital trunk on the GXW450X:

1. Go to Web GUI→**Gateway Settings**→**Interface Settings**→**Digital Hardware** to configure port type and channels.
2. Go to Web GUI→**Trunks**→**Digital Trunks** to add and edit the digital trunks.
3. Go to Web GUI→ **Trunks**→**Outbound Routes** and **Inbound Routes** to configure outbound and inbound rules for the digital trunk.

Digital Hardware Configuration

Go to Web GUI→ **Gateway Settings**→**Interface Settings**→**Digital Hardware** page and configure the following:

Port	Type	Signaling	Data channel	Options
1	E1	PRI_CPE	1 (Port 1)	
	Group Name		Channel	Options
	DefaultGroup1		2-6	

Figure 45: Digital Hardware Configuration

- o Click on to edit digital ports. Please see configuration parameters in the tables below:
- o Click on to edit group. This assigns channels to be used for the digital port. For E1, 30 B channels can be assigned to the default group; for T1, 23 B channels can be assigned to the default group.
- o If fewer than 30 B channels for E1 or 23 B channels for T1/J1 are assigned in the default group, users can click on to add more groups. This is necessary in most cases and only the default group is needed.

GXW4501

Menus

System Status

Trunks

Gateway Settings

SIP Settings

RTP Settings

Voice Prompt

Jitter Buffer

Interface Settings

System Settings

Maintenance

CDR

Edit Digital Ports: 1

Basic Settings

Advanced Settings

Span Type:

Clock:

* Signaling:

Data channel:

LBO:

Coding:

RX Gain:

TX Gain:

Codec:

Framing:

CRC Validation:

Figure 46: Digital Port Configuration

The GXW450X currently supports E1, T1, and J1 digital hardware types. When different signaling is selected for E1, T1, or J1, the settings in basic and advanced options will be different. The following tables list all the settings to configure digital ports when selecting each signaling.

Basic Settings	
Clock	<p>All E1/T1/J1 spans generate a clock signal on their transmit side. The parameter determines whether the clock signal from far end of the E1/T1/J1 is used as the master source of clock timing. If the far end is used as the master, the gateway system clock will synchronize to it.</p> <p>Master: The port will never be used as a source of timing. This is appropriate when you know the far end should always slave to you.</p> <p>Slave: The equipment at the far end of the E1/T1/J1 link is the preferred source of the master clock.</p>

Signaling	Chooses the signaling protocol that will be used on the digital port, the available options are : PRI_NET, PRI_CPE, SS7, MFC/R2
Data channel	Chooses the Data Channel for control. E1: "AMI" or "HDB3"
LBO	The line build-out (LBO) is the distance between the operators and the gateway. Please use the default value of 0dB unless distance is long. T1: "AMI" or "B8ZS" E1: "AMI" or "HDB3"
Coding	T1: "AMI" or "B8ZS"
RX Gain	Configure the RX gain for the receiving channel of the digital port. The valid range is from -24dB to +12dB.
TX Gain	Configure the TX Gain for the transmitting channel of the digital port. The valid range is -24dB to +12dB.
Codec	Select alaw or ulaw. If set to default, alaw will be used for E1.
Framing	If the span type is E1, the signaling configured as MFC/R2, then framing must configure as "cas"; If the span type is E1, signaling configured as PRI or SS7, then framing must configure as "ccs"; If span type is T1, and the signaling configure PRI or SS7, then framing can configure as "esf" or "d4"; If span type is J1, and the signaling configured as PRI or SS7, then framing can configure as "esf" or "d4".
CRC Validation	For E1, select whether to use CRC4 or None.
Advanced Settings	
Switch Type	Select switch type. EuroISDN: EuroISDN (common in Europe) NI2: National ISDN type 2 (common in the US) DMS100: Nortel DMS100 4ESS: AT&T 4ESS 5ESS: Lucent 5ESS NI1: old national ISDN type 1 Q.SIG
PRI Dial Plan	This setting is used to specify the type of the callee number. The service provider will usually verify this. The default sett "unknown". In some very unusual circumstances, you may need set it to "Dynamic" or "Redundant". Note: When one type is selected, you might not be able to dial another class of numbers. For example, if "National" is configured, you won't be able to dial local or international numbers.
PRI Local Dial Plan	This setting is used to specify the type of caller number. The service provider will usually verify this.
International Prefix National Prefix Local Prefix Private Prefix Unknown Prefix	Configure the prefix in PRI Local Dial Plan and PRI Dial Plan for each type.
PRI T310	Configure PRI T310 Timer (in seconds). The default value is 10 seconds.
PRI Indication	Select the PRI Indication. outofband: Use RELEASE, DISCONNECT, or other messages with CAUSE to indicate call progress (e.g., cause: unassig number or user busy). inband: use in-band tones to play busy or congestion signals to the other side. This is the default setting.
Reset Interval	The interval that restarts idle channels.
PRI Exclusive	This setting is used to set up the ChannelD in the SETUP message. If enabled, only the specified B channel can be used. Otherwise, select one of the channels in the B channel. If you need to override the existing channels selection routine and all PRI channels to be marked as exclusively selected, please enable it.

Facility Enable	If selected, the transmission of facility-based ISDN supplementary services (such as caller name from CPE over facility) be enabled.
SETUP ACK	When receiving a remote "SETUP" SIP message, and the "Sending Complete" field is not included in it, the gateway will a "SETUP ACK" to request more information. This option should be used if a remote device has "SETUP ACK" support issues.
Overlap Dial	Configure this option to send overlap digits. If enabled, the SETUP message can include some digits of the callee number the rest of the digits can be sent using the INFORMATION message. If disabled, the callee number will be sent via SETU message when all the digits are ready.
NSF	Some switches (AT&T especially) require network-specific facilities. Currently the supported values are "none", "sdn", "megacom", "tollfreemegacom".
PROGRESS	If enabled, GXW450x can send a signaling message to the calling party indicating that the call is still in progress and that called party has not yet answered. This can be helpful in situations where the call setup time is longer than expected, or where there may be delays in the network. If disabled, the pri incoming calls to GXW450x converts the PROGRESS message into ALERTING message and send it PRI trunk. This option is used to determine whether the peer supports the PROGRAMS message. Enabled By Default.

Table 25: Digital Hardware Configuration Parameters: E1 – PRI_NET/PRI_CPE

Basic Settings	
Clock	All E1/T1/J1 spans generate a clock signal on their transmit side. The parameter determines whether the clock signal from far end of the E1/T1/J1 is used as the master source of clock timing. If the far end is used as the master, the gateway system clock will synchronize to it. Master: The port will never be used as a source of timing. This is appropriate when you know the far end should always slave to you. Slave: The equipment at the far end of the E1/T1 link is the preferred source of the master clock.
Signaling	Chooses the signaling protocol that will be used on the digital port, the available options are : PRI_NET, PRI_CPE, SS7, MFC/R2 PRI: when one end is set to NET, the other end should be set to CPE.
Data channel	The Data channel for control. Specifies the channel to use for data connections when PRI_NET or PRI_CPE is chosen as signaling protocol. While, the first dropdown list specifies the E1/T1 port to use, and the second specifies the channel to use for data connections when SS7 is chosen. The user can group multiple E1 lines with a single data channel.
SS7 Variant	Select ITU, ANSI, or CHINA.
Originating Point Code	Originating point code is used to identify the node originating the message, always provided by the operator/ISP. ITU Format: decimal number. ANSI & CHINA Format: decimal number or XXX-XXX-XXX.
Destination Point Code	The destination point code is the address to send the message to, always provided by the operator/ISP. ITU Format: decimal number. ANSI & CHINA Format: decimal number or XXX-XXX-XXX.
First CIC	When Span Type is E1, ITU & CHINA Range: [0, 4065], ANSI Range: [0, 16353]. When Span Type is T1/J1, ITU & CHINA Range: [0, 4072], ANSI Range: [0, 16360].
Assign CIC To D-channel	If set to yes, D-channel will be assigned a CIC. Else, D-channel will not be assigned. By default, it is set to No.
Network Indicator	Network Indicator (NI) should match in nodes, otherwise, it might cause issues. Users can select "National", "National Spare", "International", or "International Spare". Usually, "National" or "International" is used.
LBO	The line build-out (LBO) is the distance between the operators and the gateway. Please use the default value of 0dB unless the distance is long.
Coding	T1:"AMI" or "B8ZS" And E1:"AMI" or "HDB3"
RX Gain	Configure the RX gain for the receiving channel of the digital port. The valid range is from -24dB to +12dB.

TX Gain	Configure the TX Gain for the transmitting channel of the digital port. The valid range is -24dB to +12dB.
Codec	Select alaw or ulaw. If set to default, alaw will be used for E1.
Framing	If the span type is E1, the signaling configured as MFC/R2, then framing must configure as "cas"; If the span type is E1, the signaling configured as PRI or SS7, then framing must configure as "ccs"; If span type is T1, and the signaling configured as PRI or SS7, then framing can configure as "esf" or "d4"; If span type is J1, and the signaling configured as PRI or SS7, then framing can configure as "esf" or "d4".
CRC Validation	For E1, select whether to use CRC4 or None.
Advanced Settings	
Called Nature of Address Indicator	Indicates the type of the called number. The receiving switch may use this indicator during translations to apply the number proper dial plan. Users can select "Unknown", "Subscriber", "National", "International" or "Dynamic".
Calling Nature of Address Indicator	Indicates the type of the calling number. The receiving switch may use this indicator during translations to apply the number proper dial plan. Users can select "Unknown", "Subscriber", "National", "International" or "Dynamic".
Original Called	This option decides on SS7 trunk outgoing calls, By controlling the "original called number IE" (Information Element) in signaling messages, the user can ensure that the correct phone number is displayed to the recipient of a call, even when the number has been rerouted or redirected. Example: if a call is routed through multiple networks or carriers, the "original called number" information can be lost or modified along the way. However, by using this SS7 option, the user can preserve the original called number and ensure that it is displayed correctly to the recipient. Disabled by Default.
Early ACM	Early ACM can be used to provide immediate feedback to callers that their call is being connected, as opposed to hearing silence or ringing until the call is actually connected to the intended party. This can help to reduce perceived wait times and improve the overall user experience. If enabled, When an inbound call is received by the gateway, the gateway can signal to the calling party that the call is being connected and that the called party will begin ringing. This early answer supervision signal is sent by the gateway before the called party's phone rings. Disabled by Default.
International Prefix National Prefix Subscriber Prefix Unknown Prefix	Configure the prefix in Called Nature of Address Indicator and Calling Nature of Address Indicator for each type.

Digital Hardware Configuration Parameters: E1 – SS7

Basic Settings	
Clock	All E1/T1/J1 spans generate a clock signal on their transmit side. The parameter determines whether the clock signal from the far end of the E1/T1/J1 is used as the master source of clock timing. If the far end is used as the master, the gateway system clock synchronizes to it. <ul style="list-style-type: none"> o Master: The port will never be used as a source of timing. This is appropriate when you know the far end should always be slave to you. o Slave: The equipment at the far end of the E1/T1 link is the preferred source of the master clock.
Signaling	Chooses the signaling protocol that will be used on the digital port. PRI: when one end is set to NET, the other end should be set to CPE
Data channel	Chooses the Data Channel for control. The user can group multiple E1 lines with a single data channel.
Variant	MFC/R2 multinational adaptation. GXW450X supports MFC/R2 standards by ITU and MFC/R2 standards in different countries or regions including Argentina, Brazil, China, Czech Republic, Colombia, Ecuador, Indonesia, Mexico, the Philippines, and Venezuela.

Category	Defines the Caller Category. Users can choose among the following options: National Subscriber, National Priority Subscriber, International Subscriber, and International Priority Subscriber.
Get ANI First	If enabled, the callee side will request the caller to send the caller number first and then called number. Note: Options "Get ANI First" and "Skip Category" cannot be enabled at the same time.
LBO	The line build-out (LBO) is the distance between the operators and the gateway. Please use the default value of 0dB unless the distance is long.
Coding	T1: "AMI" or "B8ZS" E1: "AMI" or "HDB3"
RX Gain	Configure the RX gain for the receiving channel of the digital port. The valid range is from -24dB to +12dB.
TX Gain	Configure the TX Gain for the transmitting channel of the digital port. The valid range is -24dB to +12dB.
Framing	If the span type is E1, the signaling configured as MFC/R2, then framing must configure as "cas"; If the span type is E1, the signaling configured as PRI or SS7, then framing must configure as "ccs"; If the span type is T1, and the signaling configured as PRI or SS7, then framing can configure as "esf" or "d4"; If span type is J1, and the signaling configured as PRI or SS7, then framing can configure as "esf" or "d4".
CRC Validation	For E1, select whether to use CRC4 or None.
Advanced Settings	
MF Back Timeout (ms)	MFC/R2 value in milliseconds for MF timeout. Values smaller than 500ms are not recommended. -1 represents the default value.
Metering Pulse Timeout (ms)	MFC/R2 value in milliseconds for the metering pulse timeout. Metering pulse is sent by some telcos for some R2 variants during call presumably for billing purposes to indicate costs. Should not last more than 500ms, -1 represents the default value, and for Argentina, the default value is 400ms, for others is 0ms.
Allow Collect Calls	Brazil has a special calling party category for collect calls (llamadas por cobrar) instead of using the operator (as in Mexico). The spec in Brazil says a special GB tone should be used to reject collect calls. By default, this is disabled, which means collect calls will be blocked.
Double Answer	Some gateways require a double-answer process to block collect calls. If users have a problem blocking collect calls using Group signals, please try enabling this option.
Accept On Offer	By default, it's enabled. In most cases, this option should be enabled.
Skip Category	If enabled, the callee side will request the caller to send the caller category before sending the caller number. Note: "Get ANI First" and "Skip Category" cannot be enabled at the same time.
Charge Calls	Whether or not to report to the other end "accept call with charge". This setting has no effect on most telecoms. The default setting is enabled (recommended).

Custom Options	Click on the "Custom Options" button (on the left top of the configuration dialog) and then the user can customize desired ton timer options accordingly.
-----------------------	---

Table 27: Digital Hardware Configuration Parameters: E1 – MFC/R2

Basic Settings	
Clock	All E1/T1/J1 spans generate a clock signal on their transmit side. The parameter determines whether the clock signal from far end of the E1/T1/J1 is used as the master source of clock timing. If the far end is used as the master, the gateway system clock will synchronize to it. Master: The port will never be used as a source of timing. This is appropriate when you know the far end should always slave to you. Slave: The equipment at the far end of the E1/T1/J1 link is the preferred source of the master clock.
Signaling	Chooses the signaling protocol that will be used on the digital port. PRI: when one end is set to NET, the other end should be set to CPE.
Data channel	Chooses the Data Channel for control. The user can group multiple E1 lines with a single data channel.
LBO	The line build-out (LBO) is the distance between the operators and the gateway. Please use the default value of 0dB unless distance is long.
Coding	T1: "AMI" or "B8ZS" E1: "AMI" or "HDB3"
RX Gain	Configure the RX gain for the receiving channel of the digital port. The valid range is from -24dB to +12dB.
TX Gain	Configure the TX Gain for the transmitting channel of the digital port. The valid range is -24dB to +12dB.
Codec	Select alaw or ulaw. If set to default, ulaw will be used for T1/J1.
Framing	Select "esf" or "d4". The default setting is esf.
Advanced Settings	
Switch Type	Select switch type. EuroISDN: EuroISDN (common in Europe) NI2: National ISDN type 2 (common in the US) DMS100: Nortel DMS100 4ESS: AT&T 4ESS 5ESS: Lucent 5ESS NI1: old national ISDN type 1 Q.SIG
PRI Dial Plan	This setting is used to specify the type of the callee number. The service provider will usually verify this. The default setting is "unknown". In some very unusual circumstances, you may need set it to "Dynamic" or "Redundant". Note: When one type is selected, you might not be able to dial another class of numbers. For example, if "National" is configured, you won't be able to dial local or international numbers.
PRI Local Dial Plan	This setting is used to specify the type of caller number. The service provider will usually verify this.
International Prefix National Prefix Local Prefix Private Prefix Unknown Prefix	Configure the prefix in PRI Local Dial Plan and PRI Dial Plan for each type.
PRI T310	Configure PRI T310 Timer (in seconds). The default value is 10 seconds.
PRI Indication	Select the PRI Indication. outofband: Use RELEASE, DISCONNECT, or other messages with CAUSE to indicate call progress (e.g., cause: unassigned number or user busy).

	inband: use in-band tones to play busy or congestion signals to the other side. This is the default setting. The interval that restarts idle channels.
Reset Interval	The interval that restarts idle channels.
PRI Exclusive	This setting is used to set up the ChannelID in the SETUP message. If enabled, only the specified B channel can be used. Otherwise, select one of the channels in the B channel. If you need to override the existing channels selection routine and all PRI channels to be marked as exclusively selected, please enable it.
Facility Enable	If selected, the transmission of facility-based ISDN supplementary services (such as caller name from CPE over facility) be enabled.
SETUP ACK	When receiving a remote "SETUP" SIP message, and the "Sending Complete" field is not included in it, the gateway will send a "SETUP ACK" to request more information. This option should be used if a remote device has "SETUP ACK" support issues.
Overlap Dial	Configure this option to send overlap digits. If enabled, the SETUP message can include some digits of the callee number; the rest of the digits can be sent using the INFORMATION message. If disabled, the callee number will be sent via SETUP message when all the digits are ready.
NSF	Some switches (AT&T especially) require network-specific facilities. Currently the supported values are "none", "sdn", "megacom", "tollfreemegacom", "accunet".
PROGRESS	If disabled, the pri incoming calls GXW450X to convert the PROGRESS message into ALERTING message and send it to the PRI trunk. This option is used to determine whether the peer supports the PROGRAMS message. Enabled by Default.

Table 28: Digital Hardware Configuration Parameters: T1/J1 – PRI_NET/PRI_CPE

Basic Settings	
Clock	<p>All E1/T1/J1 spans generate a clock signal on their transmit side. The parameter determines whether the clock signal from the near end of the E1/T1/J1 is used as the master source of clock timing. If the far end is used as the master, the gateway system clock will synchronize to it.</p> <ul style="list-style-type: none"> ○ Master: The port will never be used as a source of timing. This is appropriate when you know the far end should always slave to you. ○ Slave: The equipment at the far end of the E1/T1 link is the preferred source of the master clock.
Signaling	<p>Chooses the signaling protocol that will be used on the digital port.</p> <p>PRI: when one end is set to NET, the other end should be set to CPE</p>
Data channel	<p>Chooses the Data Channel for control.</p> <p>The user can group multiple E1 lines with a single data channel.</p>
SS7 Variant	Select ITU, ANSI, or CHINA.
Originating Point Code	<p>Originating point code is used to identify the node originating the message, always provided by the operator/ISP.</p> <ul style="list-style-type: none"> ○ ITU Format: decimal number. ○ ANSI & CHINA Format: decimal number or XXX-XXX-XXX.
Destination Point Code	<p>The destination point code is the address to send the message to, always provided by the operator/ISP.</p> <ul style="list-style-type: none"> ○ ITU Format: decimal number. ○ ANSI & CHINA Format: decimal number or XXX-XXX-XXX.
First CIC	<p>When Span Type is E1, ITU & CHINA Range: [0, 4065], ANSI Range: [0, 16353].</p> <p>When Span Type is T1/J1, ITU & CHINA Range: [0,4072], ANSI Range: [0, 16360].</p>

Assign CIC to D-Channel	If set to yes, D-channel will be assigned with a CIC. Else, D-channel will not be assigned with a CIC. By default, it is set to No
Network Indicator	Network Indicator (NI) should match in nodes, otherwise, it might cause issues. Users can select "National", "National Spare", "International", or "International Spare". Usually, "National" or "International" is used.
LBO	The line build-out (LBO) is the distance between the operators and the gateway. Please use the default value of 0dB unless the distance is long.
Coding	T1: "AMI" or "B8ZS" E1: "AMI" or "HDB3"
RX Gain	Configure the RX gain for the receiving channel of the digital port. The valid range is from -24dB to +12dB.
TX Gain	Configure the TX Gain for the transmitting channel of the digital port. The valid range is -24dB to +12dB.
Codec	Select alaw or ulaw. If set to default, ulaw will be used for T1/J1.
Framing	Select "esf" or "d4". The default setting is esf.
Advanced Settings	
Called Nature of Address Indicator	Indicates the type of the called number. The receiving switch may use this indicator during translations to apply the number proper dial plan. Users can select "Unknown", "Subscriber", "National", "International" or "Dynamic".
Calling Nature of Address Indicator	Indicates the type of the calling number. The receiving switch may use this indicator during translations to apply the number proper dial plan. Users can select "Unknown", "Subscriber", "National", "International" or "Dynamic".
International Prefix National Prefix Subscriber Prefix Unknown Prefix	Configure the prefix in Called Nature of Address Indicator and Calling Nature of Address Indicator for each type.

Table 29: Digital Hardware Configuration Parameters: T1/J1 – SS7



Basic Settings	
Clock	All E1/T1/J1 spans generate a clock signal on their transmit side. The parameter determines whether the clock signal from the far end of the E1/T1/J1 is used as the master source of clock timing. If the far end is used as the master, the gateway system clock will synchronize to it. <ul style="list-style-type: none"> ○ Master: The port will never be used as a source of timing. This is appropriate when you know the far end should always be a slave to you. ○ Slave: The equipment at the far end of the E1/T1 link is the preferred source of the master clock.
Signaling	Chooses the signaling protocol that will be used on the digital port.
Coding	T1: "AMI" or "B8ZS"
RX Gain	Configure the RX gain for the receiving channel of the digital port. The valid range is from -24dB to +12dB.
TX Gain	Configure the TX Gain for the transmitting channel of the digital port. The valid range is -24dB to +12dB.

Codec	Select alaw or ulaw. The default codec is "ulaw" for T1.
Framing	Select "esf" or "d4". The default setting is esf.
Advanced Settings	
RX Wink	Sets the receive wink timing. Default settings is 300ms.

Table 30: Digital Hardware Configuration Parameters: T1 – E&M Immediate

Digital Trunk Configuration

After configuring digital hardware, go to Web GUI→ **Trunks**→**Digital Trunks**.

- Click on  **Create New Digital Trunk** to add a new digital trunk.
- Click on  to configure detailed parameters for the digital trunk.
- Click on  to delete the digital trunk.

The digital trunk parameters are listed in the table below.

Trunk Name	Configure trunk name to identify the digital trunk.
Port	Configure the digital channel group used by the trunk.
Hide CallerID	Configure to hide outgoing caller ID. The default setting is "No".
Caller ID	Configure the Caller ID. This is the number that the trunk will try to use when making outbound calls. For some providers, it may not be possible to set the CallerID with this option and this option will be ignored.
CallerID Name	Configure the name of the caller.
DAHDI Out Line Selection	<p>This is to implement a Digital trunk outbound line selection strategy. Three options are available:</p> <ul style="list-style-type: none"> ○ Ascend: When the call goes out from this digital trunk, it will always try to use the first idle digital port. The port order that call will use to go out would be port 1→port 2→port 3→port 4. Every time it will start with port 1 (if it's idle). ○ Poll: When the call goes out from this digital trunk, it will use the port that is not used last time. And it will always use the in the order of port 1→2→3→4→1→2→3→4→1→2→3→4..., following the last port being used. ○ Descend: When the call goes out from this digital trunk, it will always try to use the last idle digital port. The port order that call will use to go out would be port 16→port 10→port 2→port 1. Every time it will start with port 4 (if it's idle). <p>The default setting is "Ascend" mode.</p>
Fax Gateway	<p>Enable/disable Fax Gateway on the digital trunk.</p> <p>If enabled, GXW450X will detect the fax tone on the digital interface in order to initiate T.38 fax, otherwise, it will be sent in a pass-through.</p>

Table 31: Digital Trunk Configuration Parameters

Digital Trunk Troubleshooting

After configuring the digital trunk on the GXW450X as described above, if it doesn't work as expected, users can go to capture the signaling trace GXW450X Web GUI for troubleshooting purposes.

Depending on the signaling selected for the digital trunk, users can go to the following pages to capture a trace:

PRI Signaling Trace: Web GUI→**Maintenance**→**Signaling Troubleshooting**→**PRI Signaling Trace**

SS7 Signaling Trace: Web GUI→**Maintenance**→**Signaling Troubleshooting**→**SS7 Signaling Trace**

MFC/R2 Signaling Trace: Web GUI→**Maintenance**→**Signaling Troubleshooting**→**MFC/R2 Signaling Trace**

Users can also capture a **Digital Record Trace** to record the call for other troubleshooting purposes such as audio quality problems and noise.

Below are the steps to capture the trace:

1. Click on "Start" to start capturing traces. The output result shows "Capturing..."
2. Once the test is done, click on "Stop" to stop the trace.
3. Click on "Download" to download the trace.

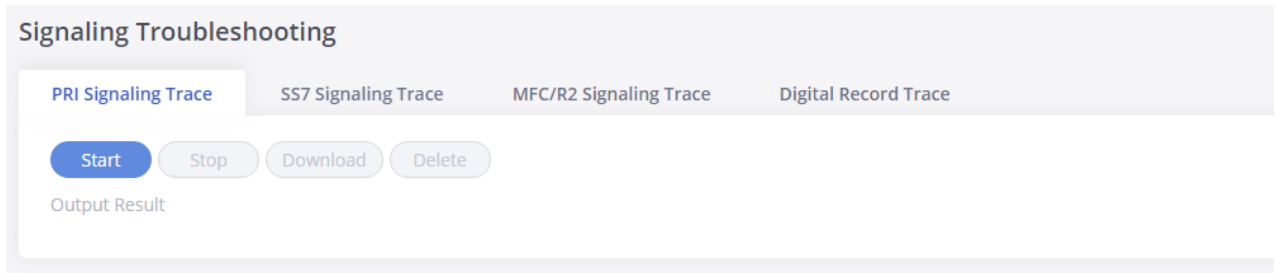

Figure 47: Troubleshooting Digital Trunks





After capturing the trace, users can download it for basic analysis. Or you can contact Grandstream Technical support in the following link for further assistance if the issue is not resolved:

<https://www.grandstream.com/support>

VoIP Trunks

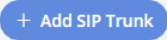
The VoIP trunks allow the GXW450X to be connected over an IP network via SIP protocol to a VoIP provider or to another device that supports the trunks.

VoIP trunks can be configured in GXW450X under Web GUI → **Trunks** → **VoIP Trunks**. Once created, the VoIP trunks will be listed with Provider Name, Hostname/IP, Username, and Options to edit/delete the trunk.

- Click on  to add a new VoIP trunk.
- Click on  to configure detailed parameters for the VoIP trunk.
- Click on  to delete the VoIP trunk.
- Click on  to configure DOD.

The VoIP trunk options are listed in the table below.

Type	Select VoIP trunk type to create. <ul style="list-style-type: none"> ○ Peer SIP Trunk ○ Register SIP Trunk
Provider Name	Configure a unique label (up to 64 characters) to identify this trunk when listed in outbound rules, inbound rules and etc.
Host Name	Configure the IP address or URL for the VoIP provider's server of the trunk.
NAT	Turn on this setting when the gateway is using public IP and communicating with devices behind NAT. If there is a one-way audio issue, usually it is related to NAT configuration or SIP/RTP port support on the firewall.
Disable This Trunk	If checked, the trunk will be disabled. Note: If a current "Register SIP trunk" is disabled, GXW450X will send UNREGISTER message (REGISTER message with expires=0) to the SIP provider.
TEL URI	If the trunk has an assigned PSTN telephone number, this field should be set to "User=Phone". Then a "User=Phone" parameter will be attached to the Request-Line and TO header in the SIP request to indicate the E.164 number. If set to "Enable", "Tel:" will be used instead of "SIP:" in the SIP request. The default setting is disabled.
From Domain	Configure the actual domain name. This can be used to override the "From" Header. For example, "trunk.GXW450X.provider.com" is the From Domain in From Header: sip: 1234567@trunk.GXW450X.provider.com

Transport	Configure the SIP transport protocol to be used in this trunk. UDP; TCP or TLS. The default setting is "UDP"
If "Type" is set to "Register SIP Trunk"	
Need Registration	Select whether the trunk needs to register on the external server or not when the "Register SIP Trunk" type is selected. The default setting is "Yes".
Allow outgoing calls if registration fails	If enabled outgoing calls even if the registration to this trunk fails will still be able to go through. Note that if we uncheck the "Need Registration" option, this option will be ignored. The default setting is "Yes".
Username	Enter the username to register to the trunk from the provider.
Password	Enter the password to register to the trunk from the provider.
AuthID	Enter the Authentication ID to register to the trunk from the provider.

Table 32: Create New SIP Trunk

After creating the SIP Trunk user can click on  to edit the trunk and have detailed parameters to configure. Below is a table of the Basic and advanced parameters of a SIP trunk.

Basic Settings	
Provider Name	Configure a unique label to identify this trunk when listed in outbound rules, inbound rules and etc.
Host Name	Configure the IP address or URL for the VoIP provider's server of the trunk.
Secondary SIP Server	The URL or IP address, and port of the SIP server. This will be used when the primary SIP server fails.
Keep Original CID	Keep CID from the inbound call when dialing out even if the option "Keep Trunk CID" is enabled. Please make sure the GXW at the other end supports matching user entry using the "username" field from the authentication line.
Keep Trunk CID	Keep trunk CID configured on Basic settings.
NAT	Turn on this option when the gateway is using public IP and communicating with devices behind NAT. If there is a one-way audio issue, usually it's related to NAT configuration or SIP/RTP port configuration on the firewall.
Disable This Trunk	If selected, the trunk will be disabled. Note: If a current SIP trunk is disabled, GXW450X will send UNREGISTER message (REGISTER message with expire to the SIP provider.
TEL URI	If the trunk has an assigned PSTN telephone number, this field should be set to "User=Phone". Then a "User=Phone" parameter will be attached to the Request-Line and TO header in the SIP request to indicate the E.164 number. If set to "Enable", "Tel:" will be used instead of "SIP:" in the SIP request. The default setting is disabled.
CallerID Name	Configure the new name of the caller when the extension has no CallerID Name configured.
From Domain	Configure the actual domain name. This can be used to override the "From" Header. For example, "trunk.GXW450X.provider.com" is the From Domain in From Header: sip:1234567@trunk.GXW450X.provider.com.
Transport	Configure the SIP transport protocol to be used in this trunk. <ol style="list-style-type: none"> 1. UDP 2. TCP 3. TLS The default setting is "UDP".
Need Registration	Select whether the trunk needs to register on the external server or not when the "Register SIP Trunk" type is selected. The default setting is "Yes".

	default setting is “Yes”.
Allow outgoing calls if registration fails	If enabled outgoing calls even if the registration to this trunk fails will still be able to go through. Note that if we uncheck “Need Registration” option, this option will be ignored. The default setting is “Yes”.
From User	Configures the actual username of the extension. This can be used to override the “From” Header
Username	Enter the username to register to the trunk from the provider.
Password	Enter the password to register to the trunk from the provider.
AuthID	Enter the Authentication ID to register to the trunk from the provider.
Advanced Settings	
Codec Preference	Select the audio codec for the VoIP trunk. The available codecs are: PCMU, PCMA, G.726, G.729, iLBC, G.722, AAL2-G.726-32, G.723, OPUS
Send PPI Header	If checked, the invite message sent to trunks will contain PPI (P-Preferred-Identity) Header.
PPI Mode	Configure how to set the PPI number, there are three possible options: <ol style="list-style-type: none"> 1. Default: Use the register number of the trunk. 2. Original CID: Use the original CID in the PPI header, if no original CID, use the default number. 3. DOD number: Use the DOD number in the PPI header, if no DOD number, use the default number.
Send PAI Header	If checked, the INVITE message sent from the trunk will contain PAI (P-Asserted-Identity) Header. Default is unchecked
PAI Header	The user and name of the PAI header. It is formatted as “name” or “” or “number”; if null, use the CID according to the priority.
DOD as From Name	If enabled and “From User” is configured, the INVITE’s From header will contain the DOD number.
Passthrough PAI Header	If enabled and “Send PAI Header” is disabled, PAI headers will be preserved as calls pass through the GXW450X.
Outbound Proxy Support	Enable sending an outbound signal to the proxy instead of the devices directly. The default setting is “unchecked”.
Outbound Proxy	When configured, the outbound signal will be sent to the proxy instead of the devices directly. The outbound proxy can be domain name or IP address.
Backup Outbound Proxy	Secondary Outbound Proxy will be used when the primary proxy cannot be connected.
Remove OBP from Route	If enabled, the Route header will be removed from SIP requests. The default setting is “No”.
DID Mode	Configure where to get the destination ID of an incoming SIP call, from SIP Request-line or To-header. The default is set “Request-line”.
DTMF Mode	Configure the default DTMF mode when sending DTMF on this trunk. Default: The global setting of DTMF mode will be used. The global setting for the DTMF Mode setting is under Web GUI→Gateway Settings→SIP Settings→ToS. RFC2833: Send DTMF using RFC2833. Info: Send DTMF using the SIP INFO message. Inband: Send DTMF using inband audio. This requires a 64-bit codec, i.e., PCMU and PCMA. Auto: Send DTMF using RFC2833 if offered. Otherwise, inband.
Enable Heartbeat Detection	If enabled, the GXW450X will regularly send SIP OPTIONS to the device to check if the device is still online. The default setting is “No”.
Heartbeat Frequency	When the “Enable Heartbeat Detection” option is set to “Yes”, configure the interval (in seconds) of the SIP OPTIONS message sent to the device to check if the device is still online. The default setting is 60 seconds.
Maximum Number of Call Lines	The maximum number of concurrent calls using the trunk. The default setting 0, which means no limit.

SRTP	<p>Enable SRTP for the VoIP trunk to use</p> <ol style="list-style-type: none"> 1. Disabled 2. Enabled but not forced 3. Enabled and forced" <p>The default setting is "Disabled". It uses SDP Security Description to exchange keys. Please refer to : SDES: https://tools.ietf.org/html/rfc4568 SRTP: https://www.ietf.org/rfc/rfc3711.txt</p>
E1/T1/J1 Error Code	<p>Selects the SIP response code to send to the VoIP trunk when the E1/T1/J1 interface is down or unavailable, the available codes are 480 and 503 , set to 480 by Default</p> <ul style="list-style-type: none"> • Error Code 480: the requested service is temporarily unavailable • Error Code 503: the service is unavailable due to a server overload or maintenance

Table 33 : VoIP Trunk Configuration Parameters – Register SIP Trunk

Basic Settings	
Provider Name	Configure a unique label to identify this trunk when listed in outbound rules, inbound rules and etc.
Host Name	Configure the IP address or URL for the VoIP provider's server of the trunk.
Keep Original CID	Keep CID from the inbound call when dialing out even if the option "Keep Trunk CID" is enabled. Please make sure the GXW at the other end supports matching user entry using the "username" field from the authentication line.
Keep Trunk CID	Keep trunk CID configured on Basic settings.
NAT	Turn on this option when the gateway is using public IP and communicating with devices behind NAT. If there is a one-way audio issue, usually it's related to NAT configuration or SIP/RTP port configuration on the firewall.
Disable This Trunk	<p>If selected, the trunk will be disabled.</p> <p>Note: If a current SIP trunk is disabled, GXW450X will send UNREGISTER message (REGISTER message with expire to the SIP provider).</p>
TEL URI	If the trunk has an assigned PSTN telephone number, this field should be set to "User=Phone". Then a "User=Phone" parameter will be attached to the Request-Line and TO header in the SIP request to indicate the E.164 number. If set to "Enable", "Tel:" will be used instead of "SIP:" in the SIP request. The default setting is disabled.
Caller ID	Configure the Caller ID. This is the number that the trunk will try to use when making outbound calls. For some providers might not be possible to set the CallerID with this option and this option will be ignored.
CallerID Name	Configure the new name of the caller when the extension has no CallerID Name configured.
From Domain	Configure the actual domain name. This can be used to override the "From" Header. For example, "trunk.GXW450X.provider.com" is the From Domain in From Header: sip:1234567@trunk.GXW450X.provider.com.
Transport	<p>Configure the SIP transport protocol to be used in this trunk.</p> <ol style="list-style-type: none"> 1. UDP 2. TCP 3. TLS <p>The default setting is "UDP".</p>
Need Registration	Select whether the trunk needs to register on the external server or not when the "Register SIP Trunk" type is selected. The default setting is "Yes".
Allow outgoing calls if registration fails	If enabled outgoing calls even if the registration to this trunk fails will still be able to go through. Note that if we uncheck "Need Registration" option, this option will be ignored. The default setting is "Yes".
From User	Configures the actual username of the extension. This can be used to override the "From" Header

Username	Enter the username to register to the trunk from the provider.
Password	Enter the password to register to the trunk from the provider.
AuthID	Enter the Authentication ID to register to the trunk from the provider.
Advanced Settings	
Codec Preference	Select the audio codec for the VoIP trunk. The available codecs are: PCMU, PCMA, G.726, G.729, iLBC, G.722, AAL2-G.726-32, G.723, OPUS
Send PPI Header	If checked, the invite message sent to trunks will contain PPI (P-Preferred-Identity) Header.
PPI Mode	Configure how to set the PPI number, there are three possible options: <ol style="list-style-type: none"> 1. Default: Use the register number of the trunk. 2. Original CID: Use the original CID in the PPI header, if no original CID, use the default number. 3. DOD number: Use the DOD number in the PPI header, if no DOD number, use the default number.
Send PAI Header	If checked, the INVITE message sent from the trunk will contain PAI (P-Asserted-Identity) Header. Default is unchecked
PAI Header	The user and name of the PAI header. It is formatted as "name" or "" or "number"; if null, use the CID according to the priority.
DOD as From Name	If enabled and "From User" is configured, the INVITE's From header will contain the DOD number.
Passthrough PAI Header	If enabled and "Send PAI Header" is disabled, PAI headers will be preserved as calls pass through the GXW450X.
Outbound Proxy Support	Enable sending an outbound signal to the proxy instead of the devices directly. The default setting is "unchecked".
Outbound Proxy	When configured, the outbound signal will be sent to the proxy instead of the devices directly. The outbound proxy can be domain name or IP address.
Backup Outbound Proxy	Secondary Outbound Proxy will be used when the primary proxy cannot be connected.
Remove OBP from Route	If enabled, the Route header will be removed from SIP requests. The default setting is "No".
DID Mode	Configure where to get the destination ID of an incoming SIP call, from SIP Request-line or To-header. The default is set "Request-line".
DTMF Mode	Configure the default DTMF mode when sending DTMF on this trunk. Default: The global setting of DTMF mode will be used. The global setting for the DTMF Mode setting is under Web GUI→Gateway Settings→SIP Settings→ToS. RFC2833: Send DTMF using RFC2833. Info: Send DTMF using the SIP INFO message. Inband: Send DTMF using inband audio. This requires a 64-bit codec, i.e., PCMU and PCMA. Auto: Send DTMF using RFC2833 if offered. Otherwise, inband.
Enable Heartbeat Detection	If enabled, the GXW450X will regularly send SIP OPTIONS to the device to check if the device is still online. The default setting is "No".
Heartbeat Frequency	When the "Enable Heartbeat Detection" option is set to "Yes", configure the interval (in seconds) of the SIP OPTIONS message sent to the device to check if the device is still online. The default setting is 60 seconds.
Maximum Number of Call Lines	The maximum number of concurrent calls using the trunk. The default setting 0, which means no limit.
SRTP	Enable SRTP for the VoIP trunk to use <ol style="list-style-type: none"> 1. Disabled 2. Enabled but not forced 3. Enabled and forced"

	<p>The default setting is “Disabled”.</p> <p>It uses SDP Security Description to exchange keys. Please refer to :</p> <p>SDES: https://tools.ietf.org/html/rfc4568</p> <p>SRTP: https://www.ietf.org/rfc/rfc3711.txt</p>
E1/T1/J1 Error Code	<p>Selects the SIP response code to send to the VoIP trunk when the E1/T1/J1 interface is down or unavailable, the available codes are 480 and 503 , set to 480 by Default</p> <ul style="list-style-type: none"> • Error Code 480: the requested service is temporarily unavailable • Error Code 503: the service is unavailable due to a server overload or maintenance

Table 34 : VoIP Trunk Configuration Parameters – Peer SIP Trunk

Direct Outward Dialing (DOD)

The GXW450X provides Direct Outward Dialing (DOD) for both Digital and SIP trunks, which is a service of a local phone company (or local exchange carrier) that allows subscribers to connect to outside lines directly.

Example of how DOD is used:

Company ABC has a SIP trunk. This SIP trunk has 4 DIDs associated with it. The main number of the office is routed to an auto attendant. The other numbers are direct lines to specific users of the company. Now when a user makes an outbound call their caller ID shows up as the main office number. This poses a problem as the CEO would like his calls to come from their direct line. This can be accomplished by configuring DOD for the CEO's number/extension.

Steps to configure DOD on the GXW4500:

1. To set up DOD go to GXW450X **Web GUI**→**Trunk**→**VoIP Trunks/Digital trunk** page.
2. Click to access the DOD options for the selected SIP Trunk.
3. Click “Create a new DOD” to begin your DOD setup
4. For “DOD Number” enter one of the numbers (DIDs) from your SIP/Digital trunk provider. In the example above

Company ABC received 4 DIDs from their provider. ABC will enter the number for the CEO's direct line.

5. Set the DOD name and If the extension number needs to be appended to the DID number click on “Add Extension”.

6. Enter a number in the “Number” field. Users have the option of entering more than one number/extension separating them using “,”. In this case Company ABC would enter the CEO's numbers/extensions.

The screenshot shows a web form titled "Create DOD" with a close button in the top right corner. The form contains the following fields and values:

- * DOD Number:** 0623154789
- DOD Name:** GS
- Add Extension:**
- * Number:** 5004,5002

At the bottom of the form are two buttons: "Cancel" and "Save".

Figure 48: DOD configuration

7. Click “Save” at the bottom.

Once completed, the user will return to the EDIT DOD page which shows all the extensions that are associated with a particular DOD.







+ Add DOD				
DOD ↕	DOD Name ↕	CallerID Number ↕		Options
0623154789	GS	5002	5004	 
Total: 1		 1 		10 / page ▾

Figure 49: Edit DOD

Outbound Routes

An outbound route is a set of rules defined by privileges and patterns that the gateway uses to decide the numbers that can go out through the trunk and who has the right to use the trunk and trunk to use for an outbound call.

To create an outbound route, Go to Web GUI → **Trunks** → **Outbound Routes**.

- Click on  to add a new outbound route.
- Click on  to edit the outbound route.
- Click on  to delete the outbound route.

On the GXW450X, the outbound route priority is based on the "Best matching pattern". For example, the GXW450X has outbound route A with pattern 1xxx and outbound route B with pattern 10xx configured. When dialing 1000 for an outbound call, outbound route B will always be used first. This is because pattern 10xx is a better match than pattern 1xxx. Only when there are multiple outbound routes with the same pattern configured, the GXW450X will use the first pattern matched.

+ Add			
Sequence ↕	Outbound Rule Name ↕	Pattern ↕	Options
1	TO_TEST	_X.	 
Total: 1		 1 	

Figure 50: Create Outbound Route

Calling Rule Name	Configure the name of the calling rule (e.g., local, long-distance, etc). Letters, digits, _ and - are allowed.
--------------------------	---

<p>Pattern</p>	<ul style="list-style-type: none"> o All patterns are prefixed with the “_”. o Special characters: <p>X: Any Digit from 0-9.</p> <p>Z: Any Digit from 1-9.</p> <p>N: Any Digit from 2-9.</p> <p>“.”: Wildcard. Match one or more characters.</p> <p>“!”: Wildcard. Match zero or more characters immediately.</p> <p>Example: [12345–9] – Any digit from 1 to 9.</p> <p>Notes:</p> <ul style="list-style-type: none"> o Multiple patterns can be used. Each pattern should be entered in new line. o Example: <p>_X.</p> <p>_NNXXNXXXXX</p> <p>_818X.</p>
<p>Enable Filter on Source Caller ID</p>	<p>When enabled, users could specify extensions allowed to use this outbound route. “Privilege Level” is automatically disabled if “Enable Filter on Source Caller ID”.</p> <p>The following two methods can be used at the same time to define the extensions as the source caller ID.</p> <ol style="list-style-type: none"> 1. Select available extensions/extension groups from the left to the right. This allows users to specify arbitrary single extension available in the PBX. 2. Custom Dynamic Route: define the pattern for the source caller ID. This allows users to define extension range instead of selecting them one by one.
<p>Main Trunk</p>	
<p>Trunk</p>	<p>Select the trunk for this outbound rule.</p>
<p>Strip</p>	<p>Allows the user to specify the number of digits that will be stripped from the beginning of the dialed string before the call is placed via the selected trunk.</p> <p>Example:</p> <p>The users will dial 9 as the first digit of long-distance calls. However, 9 should not be sent out via digital lines and the PSTN line in this case, 1 digit should be stripped before the call is placed.</p>
<p>Prepend</p>	<p>Specify the digits to be prepended before the call is placed via the trunk. Those digits will be prepended after the dialing number is stripped.</p>
<p>Failover Trunk</p>	
<p>Trunk</p>	<p>Failover trunks can be used to make sure that a call goes through an alternate route when the primary trunk is busy or down. If “Failover Trunk” is enabled and “Failover trunk” is defined, the calls that cannot be placed via the regular trunk may have a secondary trunk to go through.</p> <p>GXW450X supports up to 10 failover trunks.</p> <p>Example: The user’s primary trunk is a VoIP trunk and the user would like to use the PSTN when the VoIP trunk is not available. PSTN trunk can be configured as the failover trunk of the VoIP trunk.</p>

Strip	<p>Allows the user to specify the number of digits that will be stripped from the beginning of the dialed string before the call is placed via the selected trunk.</p> <p>Example:</p> <p>The users will dial 9 as the first digit of long-distance calls. However, 9 should not be sent out via digital lines and the PSTN line in this case, 1 digit should be stripped before the call is placed.</p>
Prepend	Specify the digits to be prepended before the call is placed via the trunk. Those digits will be prepended after the dialing number is stripped.
Time Condition	
Time Condition Mode	<p>Use Main Trunk or Failover Trunk: Use the Main Trunk and its settings during the configured time conditions. If the main trunk is unavailable, the Failover Trunk and its settings will be used instead.</p> <p>Use Specific Trunks: Use specific trunks during the configured time conditions. The Strip and Prepend settings of the Main Trunk will be used. If a trunk is unavailable during its time condition, no failover trunks will be used.</p>
Time Condition	Users could customize holiday time, office time, or a specified time to allow the outbound route to be used.

Inbound Routes

When a call comes into the GXW450X from the outside, it will usually arrive along with information about the telephone number that was dialed (known as the "DID") and the Caller ID of the person who called.

The Inbound Routes are used to tell the system what to do with calls that come into the GXW450X on any trunk based on the pattern of the DID and the caller ID of the person who called.

Inbound routes can be configured via Web GUI → **Trunks** → **Inbound Routes**.

- Click on **+ Add** button to add a new inbound route.
- Click on **Import** To import inbound routes.
- Click on **Export** to export inbound routes.
- Click on **edit** to edit the inbound route.
- Click on **delete** to delete the inbound route

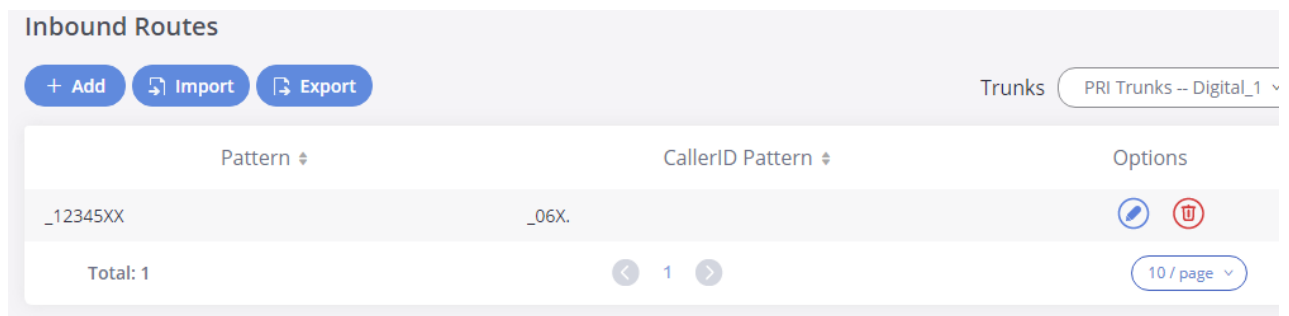

Figure 51: Create Inbound Routes

Inbound Route Configuration

Trunks	Select the trunk to configure the inbound rule.
---------------	---

<p>Pattern</p>	<ul style="list-style-type: none"> All patterns are prefixed with the “_”. Special characters: <p>X: Any Digit from 0-9.</p> <p>Z: Any Digit from 1-9.</p> <p>N: Any Digit from 2-9.</p> <p>“.”: Wildcard. Match one or more characters.</p> <p>“! ”: Wildcard. Match zero or more characters immediately.</p> <p>Example: [12345-9] – Any digit from 1 to 9.</p> <p>Notes:</p> <ul style="list-style-type: none"> Multiple patterns can be used. Each pattern should be entered in new line. Example: <table border="1" data-bbox="341 674 1299 931"> <thead> <tr> <th>Pattern</th> <th>CallerID Pattern</th> </tr> </thead> <tbody> <tr> <td>_X.</td> <td>1000</td> </tr> <tr> <td>_NNXXNXXXXX</td> <td>1001</td> </tr> <tr> <td>_818X.</td> <td></td> </tr> </tbody> </table>	Pattern	CallerID Pattern	_X.	1000	_NNXXNXXXXX	1001	_818X.		<p>Pat ter n</p>	<p>CallerID Pattern</p>	<p>_X. _NNXX NXXXXX X _818X.</p>
Pattern	CallerID Pattern											
_X.	1000											
_NNXXNXXXXX	1001											
_818X.												
<p>Pattern</p>	<p>CallerID Pattern</p>											
<p>_X. _NNXXN XXXXX _818X.</p>	<p>1000 1001</p>											
<p>Pattern</p>	<p>CallerID Pattern</p>											
<p>_X. _NNXXN XXXXX _818X.</p>	<p>1000 1001</p>											
<p>CallerID Pattern</p>	<p>All patterns are prefixed by “_” character, but please do not enter more than one “_” at the beginning. In patterns, some characters have special meanings:</p> <p>[12345-9] ... Any digit in the brackets. In this example, 1,2,3,4,5,6,7,8,9 are allowed.</p> <p>N ... Any digit from 2-9.</p> <p>. ... Wildcard, matching one or more characters.</p> <p>! ... Wildcard, matching zero or more characters immediately.</p> <p>X ... Any digit from 0-9.</p> <p>Z ... Any digit from 1-9.</p> <p>– ... Hyphen is to connect characters and it will be ignored.</p> <p>[] Contain special characters ([x], [n], [z]) represent letters x, n, z.</p>											

Set Caller ID Info	Manipulates Caller ID (CID) name and/or number within the call flow to help identify who is calling. When enabled two field will show allowing to manipulate the CalleID Number and the Caller ID Name.
CalleID Number	<p>Configures the pattern-matching format to manipulate the numbers of incoming callers or to set a fixed callerID number for calls that go through this inbound route.</p> <ul style="list-style-type: none"> ◦ `\${CALLERID(num)}`: Default value which indicates the number of an incoming caller (CID). The CID will not be modified. ◦ `\${CALLERID(num):n}`: Skips the first n characters of a CID number, where n is a number. ◦ `\${CALLERID(num):-n}`: Takes the last n characters of a CID number, where n is a number. ◦ `\${CALLERID(num):s:n}`: Takes n characters of a CID number starting from s+1, where n is a number and s is a character position (e.g. `\${CALLERID(num):2:7}` takes 7 characters after the second character of a CID number). <p>n`\${CALLERID(num)}`: Prepends n to a CID number, where n is a number.</p>
CallerID Name	<p>Default string is `\${CALLERID(name)}` which means the name of a incoming caller, it's a pattern-matching syntax format.</p> <p>A`\${CALLERID(name)}`B means Prepend a character 'A' and suffix a character 'B' to `\${CALLERID(name)}`.</p> <p>Not using pattern-matching syntax means setting fix name to incoming caller.</p>

Table 35: Inbound Rule Configuration Parameters

Inbound Route: Import/Export Inbound Route

Users can import and export inbound routes to quickly set up inbound routing on a GXW450X or to back up an existing configuration. An exported inbound route configuration can be directly imported without needing any manual modifications.

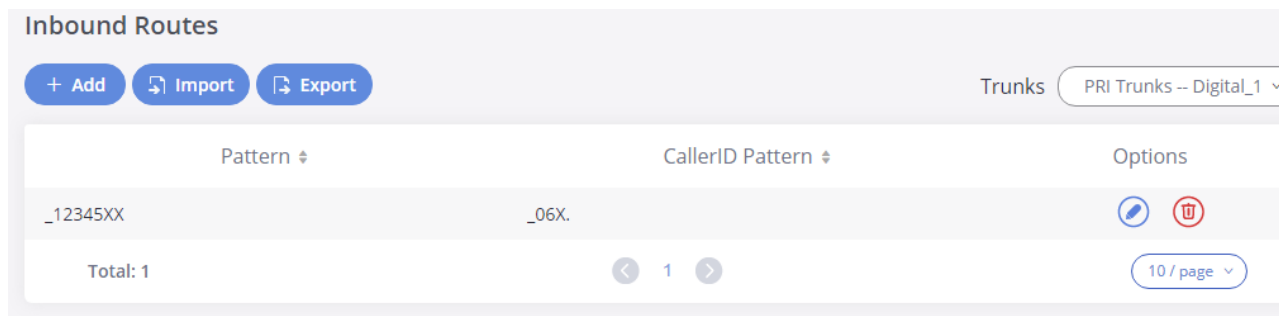

Figure 52: Import/Export Inbound Route

The imported file should be in CSV format and using UTF-8 encoding, the imported file should contain the below columns, and each column should be separated by a comma (It is recommended to use Notepad++ for the imported file creation):

- Pattern: Always prefixed with _
- CallerID Pattern: Always prefixed with _

GATEWAY SETTINGS

This section describes internal options that haven't been mentioned in previous sections yet. The settings in this section can be applied globally to GXW450X, including general configurations, jitter buffer, RTP settings, and hardware config. The options can be accessed via Web GUI → **Gateway Settings** → **General Settings**.

SIP Settings

The GXW450X SIP global settings can be accessed via Web GUI → **Gateway Settings** → **SIP Settings**.

General

On this page, users can define the Binding UDP Port for SIP protocol and Enable 486 to Failover Trunk.

SIP Settings [Save] [Cancel]

General Misc Session Timer TCP/TLS NAT ToS

*Bind UDP Port:

Enable 486 to Failover

Trunk:

Figure 53: SIP Settings – General

Bind UDP Port	Configure binding UDP port for SIP. The default setting is "5060".
Enable 486 to Failover Trunk	Reroutes failed outbound calls that receive a 486 response through the failover trunk to retry the call. If disabled, calls that receive a 486 response will be terminated. The default setting is "unchecked".

Table 36: SIP Settings – General

Misc

On this Web page, users can define the DNS mode used by the GXW450X and Outbound SIP Registrations.

SIP Settings

General Misc Session Timer TCP/TLS NAT ToS

Outbound SIP Registrations

*Register Timeout:

*Register Attempts:

DNS

DNS mode:

Figure 54: SIP Settings/Misc

Outbound SIP Registrations	
Register Timeout	Configures the register retry timeout (in seconds). The default setting is 20.
Register Attempts	Configure the number of registration attempts before giving up. 0 means continuously trying until the registration request is accepted. The default setting is "0".
DNS	
DNS mode	Selects DNS mode. Available options: <ul style="list-style-type: none"> ○ A&AAAA ○ A ○ AAAA The default setting is "A&AAAA" Note: This setting only affects the DNS queries that occur when making calls.

Session Timer

Force Timer	If checked, always request and run the session timer. The default is “unchecked”.
Timer	If checked, run the session timer only when requested by another UA. Default is “checked”.
Session Expire	Configure the maximum session refresh interval (in seconds). The default setting is 1800.
Min SE	Configure the minimum session refresh interval (in seconds). The default setting is 90.

Table 38: SIP Settings/Session Timer

TCP and TLS

TCP Enable	Configure to allow incoming TCP connections with the GXW450X. The default setting is “No”.
TCP Bind IPv4 Address	Configure the IP address for the TCP server to bind to. 0.0.0.0 means binding to all interfaces. The port number is optional. If not specified, 5060 will be used. The default setting is “0.0.0.0:5060”
TCP Bind IPv6 Address	Configure the IPv6 address for the TCP server to bind to. “[::]” means bind to all interfaces. The port number is optional with the default being 5060. For example, [2001:0DB8:0000:0000:0000:0000:1428:0000]:5060. The default setting is “[::]:5060”.
TLS Enable	Configure to allow incoming TLS connections with the GXW450X. The default setting is “No”.
TLS Bind IPv4 Address	Configure the IP address for the TLS server to bind to. 0.0.0.0 means binding to all interfaces. The port number is optional. If not specified, 5061 will be used. The default setting is “0.0.0.0:5061”. Note: The IP address must match the common name (hostname) in the certificate. Please do not bind a TLS socket to multiple IP addresses. For details on how to construct a certificate for SIP, please refer to the following document: http://tools.ietf.org/html/draft-sip-domain-certs
TLS Bind IPv6 Address	Configure the IPv6 address for the TLS server to bind to. “[::]” means bind to all interfaces. The port number is optional with the default being 5061. For example, [2001:0DB8:0000:0000:0000:0000:1428:0000]:5061. Note: The IP address must match the common name (hostname) in the certificate so that the TLS socket won’t bind to multiple IP addresses. The default setting is “[::]:5061”.
TLS Do Not Verify	If enabled, the TLS server’s certificate won’t be verified when acting as a client. The default setting is “Yes”.
TLS Self-Signed CA	This is the CA certificate if the TLS server being connected to requires a self-signed certificate, including the server’s public key. This file will be renamed as “TLS.ca” automatically. Note: The size of the uploaded “ca” file must be under 2MB.

TLS Cert	<p>This is the Certificate file (*.pem format only) used for TLS connections. It contains a private key for the client and a signed certificate the server. This file will be renamed as "TLS.pem" automatically.</p> <p>Note:</p> <p>The size of the uploaded certificate file must be under 2MB.</p>
TLS Key	<p>The size of a private key must be under 2MB. This is the private key (*.key format only) for TLS connections.</p> <p>This file will be renamed as "TLS.key" automatically.</p>
TLS CA Cert	<p>This file must be named with the CA subject name hash value. It contains CA's (Certificate Authority) public key, which is used to verify accessed servers.</p> <p>Note:</p> <p>The size of the uploaded CA certificate file must be under 2MB.</p>
TLS CA List	<p>Display a list of files under the CA Cert directory.</p>

Table 39: SIP Settings/TCP and TLS

The configuration in this section requires system reboot to take effect.

NAT

External Host	<p>Configure a static IP address and port (optional) used in outbound SIP messages if the GXW450X is behind NAT. If it is a hostname, it will only be looked up once.</p>
Use IP address in SDP	<p>If enabled, the SDP connection will use the IP address resolved from the external host. The default setting is "enabled".</p>
External UDP Port	<p>Configure the externally mapped UDP port when the GXW450X is behind a static NAT or PAT. The default setting is "5060".</p>
External TCP Port	<p>Configure the externally mapped TCP port when the GXW450X is behind a static NAT or PAT. The default setting is "5060".</p>
External TLS Port	<p>Configures the externally mapped TLS port when GXW450X is behind a static NAT or PAT. The default setting is "5061".</p>
Local Network Address	<p>Adds a list of network addresses that are considered inside of the NAT network. Multiple entries are allowed. If not configured the external IP address will not be set correctly.</p> <p>A sample configuration could be as follows:</p> <p>192.168.0.0/16</p>

Table 40: NAT Settings

ToS

ToS For SIP	<p>Configure the Type of Service for SIP packets. The default setting is None.</p>
ToS For RTP Audio	<p>Configure the Type of Service for RTP audio packets. The default setting is None.</p>
Send Compact SIP Headers	<p>If enabled, compact SIP headers will be sent. The default setting is "No".</p> <p>Note: This change requires a system reboot to take effect.</p>
Enable Relaxed DTMF	<p>Select to enable relaxed DTMF handling. The default setting is "No".</p>

DTMF Mode	<p>Configures the default mode for sending DTMF.</p> <ul style="list-style-type: none"> ◦ RFC2833: DTMF is transmitted as audio in the RTP stream but is encoded separately from the audio stream. ◦ Inband: DTMF is transmitted as audio and is included in the audio stream. Requires alaw/ulaw codecs. ◦ SIP INFO: DTMF is transmitted through a separate network connection from the media streams. ◦ Auto: DTMF mode will be negotiated with the remote peer. RFC2833 will be used by default unless the remote peer does not support it. <p>The default setting is "RFC2833".</p>
RTP Timeout	<p>Configure the timeout in seconds. When the call is in talking status, if there is no RTP activity after the timeout, the call will be terminated. The default setting is 90 seconds.</p>
RTP Hold Timeout	<p>Configure the timeout in seconds. When the call is on hold, if there is no RTP activity after the timeout, the call will be terminated. This value must be larger than "RTP Timeout". The default setting is 100 seconds.</p>
RTP Keep-alive	<p>Configure the interval (in seconds) that an RTP Keepalive packet will be sent on an SDP connection. The default setting is 0 (no RTP Keepalive).</p>
Default Incoming/Outgoing Registration Time	<p>Configure the default duration (in seconds) of incoming/outgoing registration. The default setting is 120.</p>
100rel	<p>Configure the 100rel setting on GXW450X.</p> <ul style="list-style-type: none"> ◦ No: Unsupported. ◦ Yes: Supported. ◦ Required: Forced to support. <p>The default setting is "Yes".</p>
Trust Remote Party ID	<p>Configure whether the Remote-Party ID should be trusted. The default setting is "No".</p>
Send Remote Party ID	<p>Configure whether the Remote-Party ID should be sent or not. The default setting is "No".</p>
Generate In-Band Ringing	<p>Configure whether the GXW450X should generate inband ringing or not.</p> <ul style="list-style-type: none"> ◦ Yes: The GXW450X will send 180 Ringing followed by 183 Session Progress and in-band audio. ◦ No: The GXW450X will send 180 Ringing if 183 Session Progress has not been sent yet. If the audio path is established already with 183 then send in-band ringing. ◦ Never: Whenever ringing occurs, the GXW450X will send 180 Ringing as long as 200OK has not been set yet. <p>The default setting is "Never".</p>
Server User Agent	<p>Configure the user agent string for the GXW450X.</p>
Default Incoming/Outgoing Registration Time	<p>Configure the default duration (in seconds) of incoming and outgoing registration. The default setting is 120 seconds.</p>

Table 41: ToS Settings

RTP Settings

RTP Settings

RTP Start	Configure the RTP port starting number. The default setting is 10000.
RTP End	Configure the RTP port ending address. The default setting is 20000.

Strict RTP	Configure to enable or disable strict RTP protection. If enabled, RTP packets that do not come from the source of the RTP stream be dropped. The default setting is "Disable".
RTP Checksums	Configure to enable or disable RTP Checksums on RTP traffic. The default setting is "Disable".

Table 42: RTP Settings

Payload Type Settings

The GXW450X payload type for audio codecs can be configured here.

AAL2-G.726	Configure payload type for ADPCM (G.726, 32kbps, AAL2 codeword packing). The valid range is between 96 and 127. The default setting is 112.
DTMF	Configure payload type for DTMF. The valid range is between 96 and 127. The default setting is 101.
G.721 Compatible	Configure to enable/disable G.721 compatible. The default setting is Yes.
G.726	Configure the payload type for G.726 if "G.721 Compatible" is disabled. The default setting is 111.
iLBC	Configure the payload type for iLBC. The valid range is between 96 and 127. The default setting is 97.
OPUS	Configure the payload type for OPUS. The valid range is between 96 and 127. The default setting is 123.

Table 43: Payload Type Configuration

- Click on **Default All** to set the values of the payload parameters to the factory default values
- While configuring the payload values users can Click on **Reset All** to reset the values to the last saved values on the gateway.

Voice Prompt

The GXW450X supports multiple languages in Web GUI as well as system voice prompt. The following languages are currently supported in the system voice prompt:

English (United States), British English, Arabic, Chinese, Dutch, French, German, Greek, Hebrew, Italian, Polish, Portuguese, Russian, Spanish, Catalan, Swedish, Czech, and Turkish.

English (United States) and Chinese voice prompts are built-in with the GXW450X already. The other languages provided by Grandstream can be downloaded and installed from the GXW450X Web GUI directly. Additionally, users could customize their own voice prompts, package them and upload them to the GXW450X.

Language settings for voice prompts can be accessed under Web GUI → **Gateway Settings** → **Voice Prompt** → **Language**.

Download and Install Voice Prompt Package

To download and install voice prompt package in different languages from GXW450X Web GUI, click on **Check Prompt List** button.

The screenshot shows the 'Voice Prompt' configuration page. At the top right, there are 'Save' and 'Cancel' buttons. Below the title, there are two main buttons: 'Check Prompt List' and 'Upload Voice Prompt Package'. Underneath, the 'Language' section is visible, featuring two radio button options: 'English : en' (selected) and '中文 : zh'.

Figure 55: Language Settings for Voice Prompt

A new dialog window of the voice prompt package list will be displayed. Users can see the version number (latest version available V.S. current ins version), package size, and options to upgrade or download the language

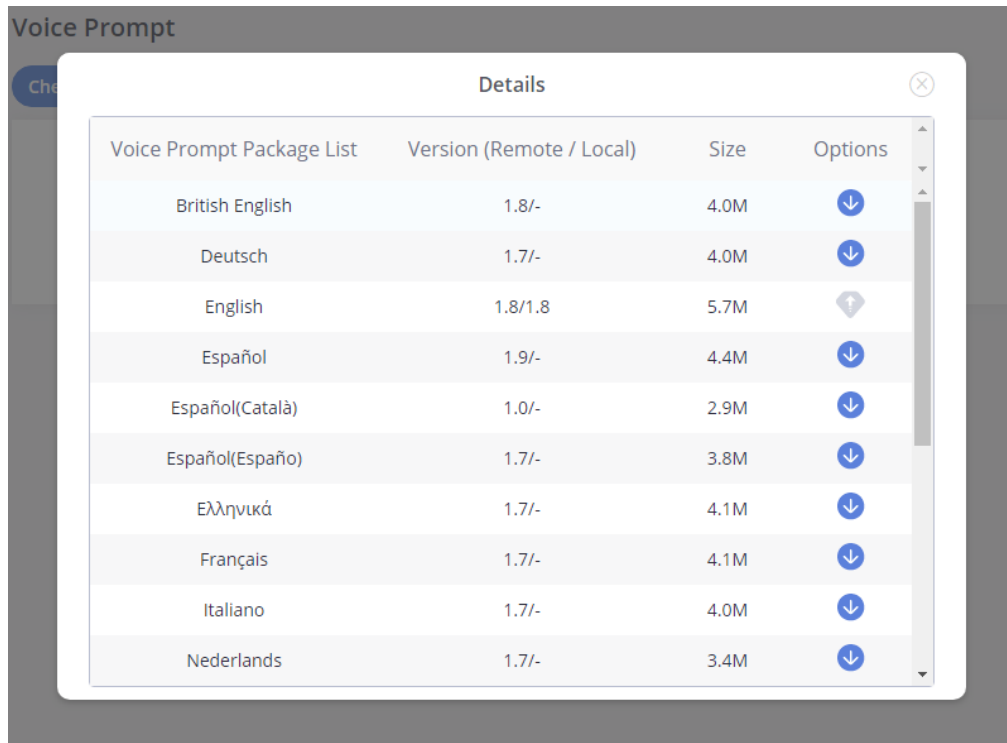

Voice Prompt Package List	Version (Remote / Local)	Size	Options
British English	1.8/-	4.0M	↓
Deutsch	1.7/-	4.0M	↓
English	1.8/1.8	5.7M	⬇
Español	1.9/-	4.4M	↓
Español(Català)	1.0/-	2.9M	↓
Español(Español)	1.7/-	3.8M	↓
Ελληνικά	1.7/-	4.1M	↓
Français	1.7/-	4.1M	↓
Italiano	1.7/-	4.0M	↓
Nederlands	1.7/-	3.4M	↓

Figure 56: Voice Prompt Package List

Click on  to download the language to the GXW450X. The installation will be automatically started once the downloading is finished.

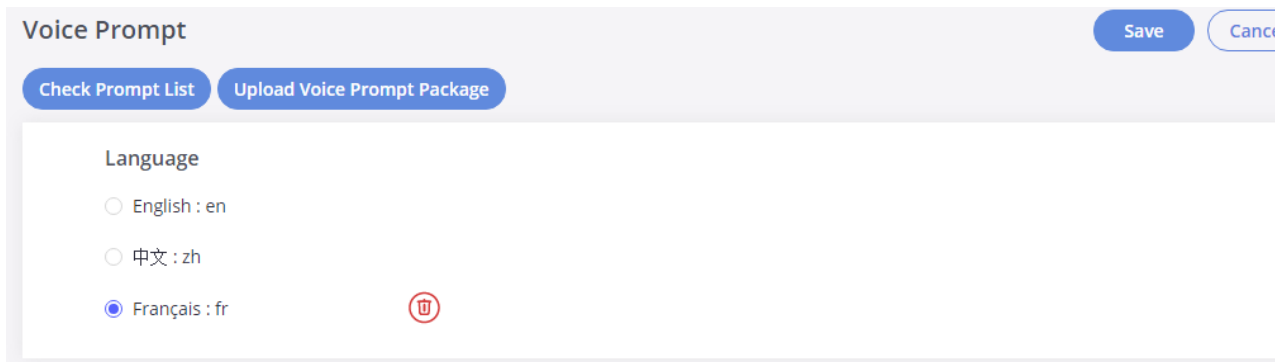

Voice Prompt Save Cancel

Check Prompt List Upload Voice Prompt Package

Language

English : en

中文 : zh

Français : fr 

Figure 57: New Voice Prompt Language Added

A new language option will be displayed after successfully installed. Users then could select it to apply in the GXW450X system voice prompt or d from the GXW450X

Manual Upload of Prompt Package

Users can upload the prompt package manually to the GXW450X. Users can create their own prompt package for different languages and use the the default voice prompts.

To upload the voice prompt to the GXW450X, press the Upload Voice Prompt Package button and brows the prompt package.

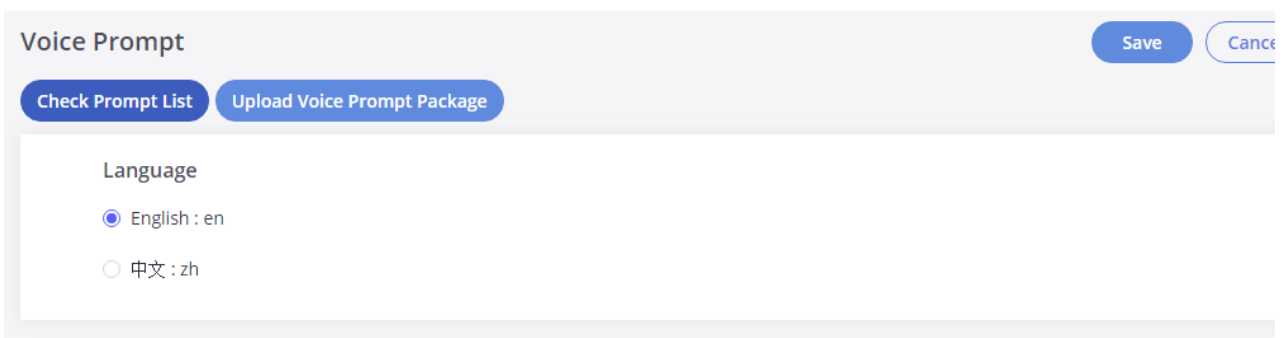

Voice Prompt Save Cancel

Check Prompt List Upload Voice Prompt Package

Language

English : en

中文 : zh

Figure 58: Upload Voice prompt Package

The prompt package should be in tar.bz2, tar.gz, tar.z, tgz, tar, bz2, zip or gz format.

Call Failure Tone Settings

SIP Trunk Prompt Tone

Prompt Tone Settings tab has been added to the GXW to help users choose which prompt will be played by the GXW during call failure, the following voice message responses have been added and can be set to be played for 4XX, 5XX, and 6XX call failures:

- The default for 404 and 604 status codes: "Your call can't be completed as dialed. Please check the number and dial again."
- The default for 5xx status codes: "Server error. Please check your device."
- The default for 403 and 603 status codes: "The call was rejected by the server. Please try again later."
- The default for all other status codes: "All circuits are busy now. Please try again later."

Additionally, custom voice messages recorded and uploaded in Gateway Settings → Voice Prompt → Custom Prompt can be used for these failure responses instead of the default messages.

SIP Trunk Prompt Tone		General Call Failure Tones	
415:	sip-trunk-out-busy	416:	sip-trunk-out-busy
420:	sip-trunk-out-busy	421:	sip-trunk-out-busy
423:	sip-trunk-out-busy	480:	sip-trunk-out-busy
481:	sip-trunk-out-busy	482:	sip-trunk-out-busy
483:	sip-trunk-out-busy	484:	sip-trunk-out-busy
485:	sip-trunk-out-busy	486:	sip-trunk-out-busy
487:	sip-trunk-out-busy	488:	sip-trunk-out-busy
491:	sip-trunk-out-busy	493:	sip-trunk-out-busy
Reset All Default All		501:	sip-trunk-out-server-error
500:	sip-trunk-out-server-error	503:	sip-trunk-out-server-error
502:	sip-trunk-out-server-error	505:	sip-trunk-out-server-error
504:	sip-trunk-out-server-error	603:	sip-trunk-out-rejected
513:	sip-trunk-out-server-error	606:	sip-trunk-out-busy
Reset All Default All			
600:	sip-trunk-out-busy		
604:	sip-trunk-out-wrong-number		

Figure 59: SIP Trunk Prompt Tone

General Call Failure Tone

Moreover, users also have the possibility to customize the prompt for typical call failure reasons like (no permission to allow outbound calls, busy incorrect number dialed ...etc.).

To customize these prompts users could record and upload their own files under "Gateway Settings → Voice Prompt → Custom Prompts" then set each one for a specific call failure case under the "Gateway Settings → Call Failure Tone Settings → General Call Failure Tones" page as shown on the following figure:

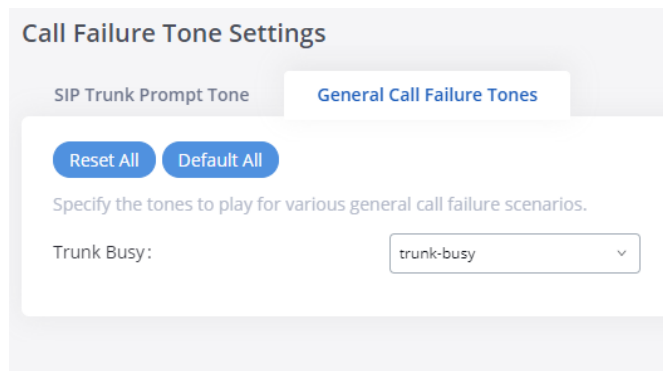

Figure 60: General call Failure Tones

Jitter Buffer

A jitter buffer is used at the receiving equipment to store incoming RTP packets, re-align them in terms of timing and check they are in the correct order. If some arrive slightly out of sequence then, provided it is large enough, the jitter buffer can put them back into the right sequence. However, for it to work the receiving device must delay the audio very slightly while it checks and reassembles the packet stream.

Below are the Jitter buffer Settings to control the size of the buffer and its implementation mode:

Enable Jitter Buffer	Select to enable the jitter buffer on the sending side of the SIP channel. The default setting is “No”.
Jitter Buffer Size	Configure the time (in ms) to buffer. This is the jitter buffer size used in the “Fixed” jitter buffer or used as the initial time for the “adaptive” jitter buffer. The default setting is 100.
Implementation	<p>Configure the jitter buffer implementation on the sending side of a SIP channel. The default setting is “Fixed”.</p> <ul style="list-style-type: none"> o Fixed <p>The size is always equal to the value of “Max Jitter Buffer”.</p> <ul style="list-style-type: none"> o Adaptive <p>The size is adjusted automatically and the maximum value equals the value of “Max Jitter Buffer”.</p>
Max Jitter Buffer	Configure the maximum time (in ms) to buffer for “Adaptive” jitter buffer implementation or used it as the jitter buffer size for “Fixed” jitter buffer implementation. The default setting is 100.

Table 44: Jitter Buffer Settings

Interface Settings

The GXW450X supports E1/T1/J1 which are physical connection technologies used in digital networks. T1 is the North American standard, J1 is used in Japan, whereas E1 is the European standard. GXW450X supports four signaling protocols: PRI_NET, PRI_CPE, MFC/R2, and SS7. PRI provides a varying number of channels depending on the standards in the country of implementation (E1, T1, or J1); MFC/R2 is a signaling protocol heavily used over trunks; SS7 uses out-of-band signaling, which travels on a separate, dedicated channel rather than within the same channel as the telephone call, providing more efficiency and higher security level when the telephone calls are set up.

The interface settings page allows the configuration of digital hardware parameters. For more details, refer to the **[Digital Hardware Configuration]** section.

GXW450X also allows the users to configure **Tone Region** by choosing their country to set the default tones for dial tone, busy tone, and ring tone to be sent. If not specified, the default setting is “The United States”.

MAINTENANCE

The Maintenance section lists different tools to help troubleshoot the issues that might be encountered while using the GXW450X alongside a set of options to manage users, control web GUI access, upgrade the firmware, backup the configuration, take ethernet and Digital traces ...etc.

User Management

User management is on the Web GUI→ **Maintenance**→**User Management** page. Users could create multiple accounts for different administrator in to the GXW450X Web GUI.

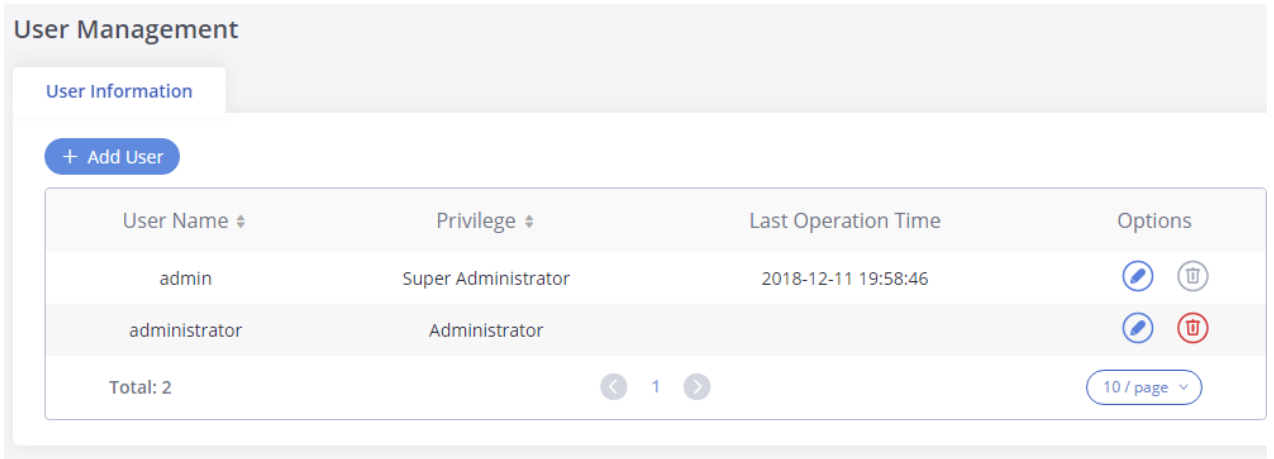

Figure 61: User Management Page Display

- Click on **+ Add User** To add a user
- Click on to edit the user
- Click on to delete the user

When logged in as Super Admin, click on **+ Add User** to create a new account for Web GUI user. The following dialog will prompt. Configure the parameters as shown in below table.

Figure 62: Create New User

User Name	Configures a username to identify the user which will be required in Web GUI login. Letters, digits, and underscores are allowed in the user name.
Privilege	This is the role of the Web GUI user. Currently, only "Admin" is supported when Super Admin creates a new user.
User Password	Configures a password for this user which will be required in Web GUI login. Letters, digits, and underscores are allowed.
Department	Enters the necessary information to keep a record for this user.
Fax	
Email Address	
First Name	
Last Name	

Home Number
Mobile Phone Number

Table 45: Create New User Information

Change Information

Change Password

Follow the steps below to change the Web GUI access password.

1. Go to the Web GUI→**Maintenance**→**Change Information** page.
2. Enter the old password first.
3. Enter the new password and retype the new password to confirm. The new password has to be at least 4 characters. The maximum length of the password is 16 characters.
4. Configure the Email Address that is used when login credentials are lost.
5. Click on “Save” and the user will be automatically logged out.
6. Once the web page comes back to the login page again, enter the username “admin” and the new password to login.

Figure 63: Change Password

Enter Old Password	Enter the old Password for GXW450X
Enable Change Password	When enabled, the fields to enter the new password will be displayed
Enter New Password	Enter the New Password for GXW450X
Re-enter New Password	Retype the New Password for GXW450X

Table 46: Change Password Parameters

Change Binding Email

GXW450X allows users to configure binding email in case log in password is lost. GXW450X login credentials will be sent to the designated email address. The feature can be found under Web GUI→**Maintenance**→**Change Information**→**Change Binding Email**.

Change Binding Email

Email Address: [Email Template](#)

Figure 64: Change Binding Email

Login Settings

After the user logs in to the GXW450X Web GUI, the user will be automatically logged out after a certain timeout, or he/she can be banned for a period if the login timeout is exceeded. Those values can be specified under the GXW450X web GUI→**Maintenance**→**Change Information**→**Login Settings** page.

The “**User Login Timeout**” value is in minutes and the default setting is 10 minutes. If the user doesn’t make any operation on Web GUI within the timeout, the user will be logged out automatically. After that, the Web GUI will be redirected to the login page and the user will need to enter the username and password to log in.

If set to 0, there is no timeout for the Web GUI login session and the user will not be automatically logged out.

The “**maximum number of login attempts**” can prevent the GXW450X from brute force decryption, if this number is exceeded user IP address will be banned from accessing the GXW for a period based on user configuration, the default value is 5.

“**User ban period**” specifies the period in minutes an IP will be banned from accessing the GXW if the User max number of try login is exceeded, the default value is 5.

“**Login Banned User List**” shows the list of IPs banned from the GXW.

“**Login White List**” Users can add a list of IPs to avoid the above restriction, thus, they can exceed the User’s max number of try login.

The screenshot shows the 'Change Information' page with the 'Login Settings' tab selected. The page has a 'Save' button and a 'Cancel' button in the top right corner. The 'Login Settings' section contains three input fields: '* User Login Timeout:' with the value '10', '* Maximum number of login attempts:' with the value '5', and '* User ban period:' with the value '5'. Below this are two tables. The first table is titled 'Login Banned User List' and has columns for 'IP Address', 'User Name', 'Banned Time', and 'Options'. It currently shows 'No Data'. The second table is titled 'Login Whitelist' and has columns for 'IP Address' and 'Options'. It also shows 'No Data'. There is an '+ Add' button next to the 'Login Whitelist' title. A note below the 'Login Whitelist' table states: 'The IP addresses in the Login Whitelist will not be restricted. This option doesn't support network segment format.'

Figure 65: Login Timeout Settings

Operation Log

The admin has the authority to view operation logs on the GXW450X Web GUI→**Maintenance**→**Operation Log** page. Operation logs list the operations done by all the Web GUI users, for example, Web GUI login, creating trunk, creating outbound rule, etc. There are 7 columns to record the operation details: “Date”, “User Name”, “IP Address”, “Results”, “Page Operation”, “Specific Operation” and “Remark”.

Operation Log

Filter

Date	User Name	IP Address	Results	Page Operation	Specific Operation	Remark
2018-12-12 02:17:02	admin	172.16.1.62	Operation successful	downloadFile	type: syslog. ⓘ	Click to modify notes.
2018-12-12 02:16:55	admin	172.16.1.62	Operation successful	Login: Login	User Name: admin. ⓘ	Click to modify notes.
2018-12-12 02:16:48	admin	172.16.1.62	Wrong account or password!	Login: Login	User Name: admin. ⓘ	Click to modify notes.
2018-12-12 02:16:46	admin	172.16.1.62	Wrong account or password!	Login: Login	User Name: admin. ⓘ	Click to modify notes.
2018-12-12 02:16:41	admin	172.16.1.62	Wrong account or password!	Login: Login	User Name: admin. ⓘ	Click to modify notes.
2018-12-11 23:06:34	admin	41.250.164.94	Operation successful	Login: Login	User Name: admin. ⓘ	Click to modify notes.
2018-12-11 22:51:17	admin	41.250.164.94	Operation successful	Login: Login	User Name: admin. ⓘ	Click to modify notes.
2018-12-11 22:50:59	admin	41.250.164.94	Operation successful	Logout: Logout	User Name: undefined. ⓘ	Click to modify notes.
2018-12-11 22:41:13	admin	41.250.164.94	Operation successful	Login: Login	User Name: admin. ⓘ	Click to modify notes.
2018-12-11 22:40:57	admin	41.250.164.94	Operation successful	Extensions: Update User Information	User Name: admin. ⓘ	Click to modify notes.

Total: 181 10 / page

Figure 66: Operation Logs

The operation log can be sorted and filtered for easy access. Click on the header of each column to sort. For example, clicking on "Date" will sort according to the operation date and time. Clicking on "Date" again will reverse the order.

Date	The date and time when the operation is executed.
User Name	The username of the user who performed the operation.
IP Address	The IP address from which the operation is made.
Results	The result of the operation.
Page Operation	The page where the operation is made. For example, login, logout, delete user, create trunk and etc.
Specific Operation	Click on ⓘ to view the options and values configured by this operation.
Remark	Allows users to add notes and remarks to each operation

Users could also filter the operation logs by time condition, IP address and/or username. To use the filter, click on and configure the conditions then click on .

Operation Log

Filter

Start Time:
 End Time:

IPv4/IPv6 Address:
 User Name:

Date	User Name	IP Address	Results	Page Operation	Specific Operation	Remark
2018-12-11 15:22:44	admin	172.16.1.62	Operation successful	Network Troubleshooting: Download File	Type: troubleshooting. ⓘ	Click to modify notes.
2018-12-11 15:13:06	admin	172.16.1.62	Operation successful	Network Troubleshooting: Download File	Type: troubleshooting. ⓘ	Click to modify notes.
2018-12-11 15:10:55	admin	172.16.1.62	Operation successful	Login: Login	User Name: admin. ⓘ	Click to modify notes.

Total: 3
 < 1 >
10 / page

Figure 67: Operation Logs Filter

The above figure shows an example that operations made by user "admin" on a device with IP 172.16.1.62 from 2018-12-08 16:38 to 2018-12-11 15:22:44 are filtered out and displayed.

To delete operation logs, users can perform filtering first and then click on to delete the filtered result of operation. Or users can click on to delete all operation logs at once.

Syslog

On the GXW450X, users could dump the Syslog information to a remote server under Web GUI → **Maintenance** → **Syslog**. Enter the Syslog server hostname or IP address and select the module/level for the Syslog information.

The default Syslog level for all modules is "error", which is recommended in your GXW450X settings because it can be helpful to locate the issues errors happen.

Some typical modules for GXW450X functions are as follows and users can turn on "notice" and "verb" levels besides the "error" level.

- **pbx**: This module is related to general PBX functions.
- **pjsip**: This module is related to SIP calls.
- **chan_dahdi**: This module is related to digital calls (E1/T1/J1).

Syslog Save

Syslog Configuration

Syslog Server:

Enable Write Syslog Into Cache:

Time Interval (seconds):

Syslog

Download Clean

Process Log

All Modules CDR API Log PBX MID log Apply Change Log CGI Log Alert Log Other Log

PBX Modules

Module ▾	All Level	Error	Warn	Notice	Debug	Verbose
All Modules	<input type="checkbox"/>	<input checked="" type="checkbox"/>	<input type="checkbox"/>	<input type="checkbox"/>	<input type="checkbox"/>	<input type="checkbox"/>
ARI	<input type="checkbox"/>	<input checked="" type="checkbox"/>	<input type="checkbox"/>	<input type="checkbox"/>	<input type="checkbox"/>	<input type="checkbox"/>
Bridge	<input type="checkbox"/>	<input checked="" type="checkbox"/>	<input type="checkbox"/>	<input type="checkbox"/>	<input type="checkbox"/>	<input type="checkbox"/>
CLI	<input type="checkbox"/>	<input checked="" type="checkbox"/>	<input type="checkbox"/>	<input type="checkbox"/>	<input type="checkbox"/>	<input type="checkbox"/>
Channel	<input type="checkbox"/>	<input checked="" type="checkbox"/>	<input type="checkbox"/>	<input type="checkbox"/>	<input type="checkbox"/>	<input type="checkbox"/>
DNS	<input type="checkbox"/>	<input checked="" type="checkbox"/>	<input type="checkbox"/>	<input type="checkbox"/>	<input type="checkbox"/>	<input type="checkbox"/>
DSP	<input type="checkbox"/>	<input checked="" type="checkbox"/>	<input type="checkbox"/>	<input type="checkbox"/>	<input type="checkbox"/>	<input type="checkbox"/>
Device	<input type="checkbox"/>	<input checked="" type="checkbox"/>	<input type="checkbox"/>	<input type="checkbox"/>	<input type="checkbox"/>	<input type="checkbox"/>
HTTP	<input type="checkbox"/>	<input checked="" type="checkbox"/>	<input type="checkbox"/>	<input type="checkbox"/>	<input type="checkbox"/>	<input type="checkbox"/>
IO	<input type="checkbox"/>	<input checked="" type="checkbox"/>	<input type="checkbox"/>	<input type="checkbox"/>	<input type="checkbox"/>	<input type="checkbox"/>

10 / page ▾

Syslog Level

All Modules DTMF SECURITY

Figure 68: Syslog Settings

Syslog is usually for debugging and troubleshooting purpose. Turning on all levels for all Syslog modules is not recommended for daily usage. Too many Syslog prints might cause traffic and affect system performance.

The reserved size for Syslog entries on the cache memory of the GXW is 50M, once this size is reached the GXW will clean up 2M of the oldest Sys entries to allow to save new logs.

System Events

The GXW450X can monitor important system events, log the alerts and send Email notifications to the system administrator.

Alert Log

Under Web GUI → **Maintenance** → **System Events** → **Alert Log**, system messages are listed when the alert is triggered for the configured system ev. The following picture shows the "User Login Successes", "User Login Failed" and "System Reboot" alert logs.

Alert Log Alert Events List Alert Contact

Delete Search Result (s) Delete All Filter

Time ↕	Event Name ↕	Type ↕	Content
2018-12-12 00:00:08	User login success	Generate Alert	Logged in system successfully! The username is: adminIP:41.250.164.94
2018-12-12 00:00:04	User login failed	Generate Alert	Logged in system failed! The username is: adminIP:41.250.164.94
2018-12-11 23:57:38	System Reboot	Generate Alert	System has restarted. The latest restart time is: 2018-12-11 23:57:20.

Total: 3 10 / page ▾

Figure 69: System Events → Alert Log

Users could also filter the Alert Logs by time condition, Event Name, and/or Type. To use the filter, click on [Filter ^](#) and configure the condition then click on [Search](#).

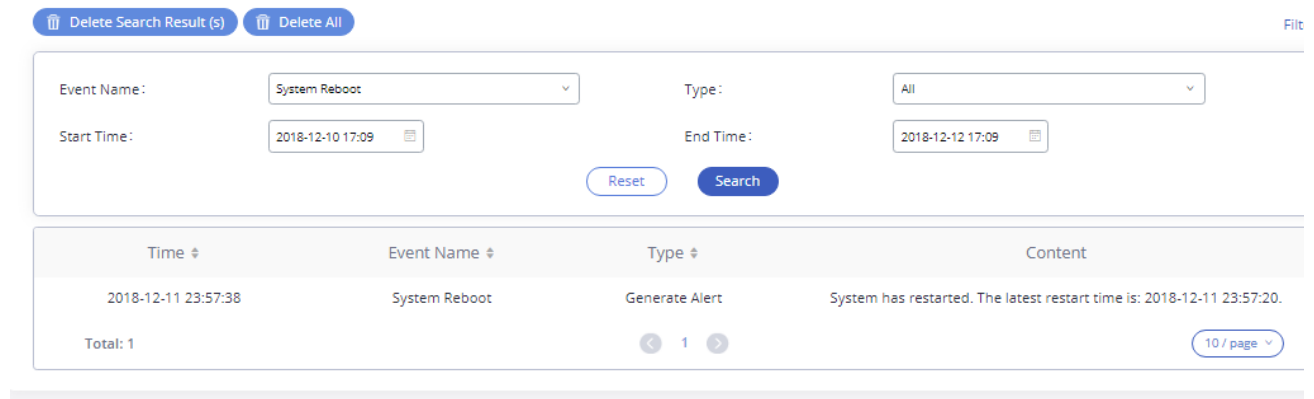

Figure 70: Alert Log Filter

The above figure shows an example of a System reboot Alerts logged on 2018-12-11 at 23:57 displayed using the filter Event name System Reboot.

To delete alert logs, users can perform filtering first and then click on [Delete Search Result \(s\)](#) to delete the filtered result of operation logs. users can click on [Delete All](#) to delete all alert logs at once.

Alert Events List

The system alert events list can be found under Web GUI→**Maintenance**→**System Events**→**Alert Events**. The following event is currently supported for the GXW450X which will have an alert, and/or an Email generated if occurred:

- **Disk Usage**
- **Modify Super Admin Password**
- **Memory Usage**
- **System Reboot**
- **System Update**
- **System Crash**
- **Register SIP trunk failed**
- **Restore Config**
- **User Login Success**
- **User Login Failed**
- **SIP Outgoing Call through Trunk Failure**
- **Fail2ban Blocking**
- **SIP Peer Trunk Status**
- **User Login Banned**
- **External Disk Usage**
- **The CDR database is corrupted**

Click on [🔗](#) to configure the parameters for each event

1. Disk Usage



Figure 71: System Events→Alert Events Lists: Disk Usage

- **Detect Cycle:** The GXW450X will perform the internal disk usage detection based on this cycle. Users can enter the number and then select second(s)/minute(s)/hour(s)/day(s) to configure the cycle.
- **Alert Threshold:** If the detected value exceeds the threshold (in percentage), the GXW450X system will send the alert.

2. External Disk Usage

Alert Settings: External Disk Usage



The screenshot shows a configuration panel titled "Alert Settings: External Disk Usage". It contains two rows of settings. The first row is labeled "* Detect Cycle:" and has a text input field containing the number "10" and a dropdown menu currently set to "minute...". The second row is labeled "* Alert Threshold:" and has a text input field containing the number "80" followed by a percentage symbol "%".

Figure 72: System Events → Alert Events Lists: External Disk Usage

- **Detect Cycle:** The GXW450X will perform the External disk usage detection based on this cycle. Users can enter the number and then select second(s)/minute(s)/hour(s)/day(s) to configure the cycle.
- **Alert Threshold:** If the detected value exceeds the threshold (in percentage), the GXW450X system will send the alert.

3. Memory Usage

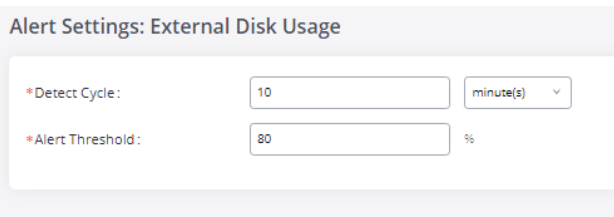

The screenshot shows a configuration panel titled "Alert Settings: External Disk Usage". It contains two rows of settings. The first row is labeled "* Detect Cycle:" and has a text input field containing the number "10" and a dropdown menu currently set to "minute(s)". The second row is labeled "* Alert Threshold:" and has a text input field containing the number "80" followed by a percentage symbol "%".

Figure 73: System Events → Alert Events Lists: Memory Usage

- **Detect Cycle:** The GXW450X will perform the memory usage detection based on this cycle. Users can enter the number and then select second(s)/minute(s)/hour(s)/day(s) to configure the cycle.
- **Alert Threshold:** If the detected value exceeds the threshold (in percentage), the GXW450X system will send the alert.

4. System Crash

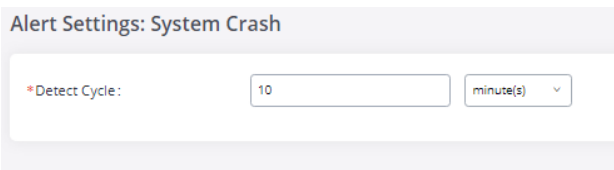

The screenshot shows a configuration panel titled "Alert Settings: System Crash". It contains one row of settings labeled "* Detect Cycle:" with a text input field containing the number "10" and a dropdown menu currently set to "minute(s)".

Figure 74: System Events → Alert Events Lists: System Crash

- **Detect Cycle:** The GXW450X will detect the event at each cycle based on the specified time. Users can enter the number and then select second(s)/minute(s)/hour(s)/day(s) to configure the cycle.

Click on the switch OFF ON to turn on/off the alert and Email notification for the event. Users could also select the checkbox for each event then click on buttons "Alert On", "Alert Off", "Email Notification On", or "Email Notification Off" to control the alert and Email notification configuration.

Alert Contact

Users could add the administrator's Email address under Web GUI → Maintenance → System Events → Alert Contact to send the alert notification. Up to 10 Email addresses can be added.

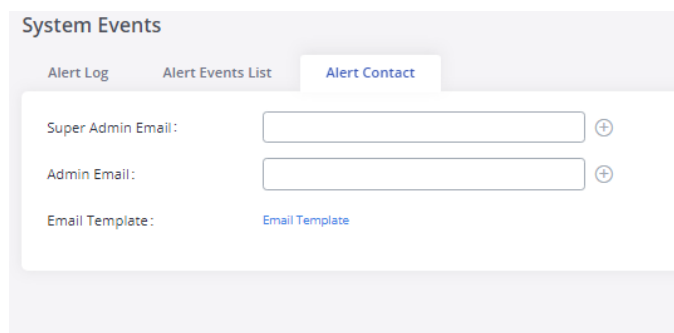

The screenshot shows a configuration panel titled "System Events" with three tabs: "Alert Log", "Alert Events List", and "Alert Contact". The "Alert Contact" tab is active. It contains three rows of settings: "Super Admin Email:" with a text input field and a plus icon; "Admin Email:" with a text input field and a plus icon; and "Email Template:" with a blue link labeled "Email Template".

Figure 75: Alert Contact

Upgrade

The GXW450X can be upgraded to a new firmware version remotely or locally. This section describes how to upgrade your GXW450X via network upload.

Upgrading via Network

The GXW450X can be upgraded via TFTP/HTTP/HTTPS by configuring the URL/IP Address for the TFTP/HTTP/HTTPS server and selecting a download method. Configure a valid URL for TFTP, HTTP, or HTTPS; the server name can be FQDN or IP address.

The upgrading configuration can be accessed via Web GUI→**Maintenance**→**Upgrade**.

The screenshot shows a configuration form with the following fields:

- Upgrade Via: HTTP (selected in a dropdown menu)
- Firmware Server Path: fw.ipvideotalk.com/gs
- Firmware File Prefix: (empty text box)
- Firmware File Suffix: (empty text box)
- HTTP/HTTPS Username: (empty text box)
- HTTP/HTTPS Password: (empty text box)

Figure 76: Network Upgrade

Upgrade Via	Allow users to choose the firmware upgrade method: TFTP, HTTP, or HTTPS.
Firmware Server Path	Configures firmware server path. For example, firmware.grandstream.com
Firmware File Prefix	If configured, only the firmware with the matching encrypted prefix will be downloaded.
Firmware File Suffix	If configured, only the firmware with the matching encrypted postfix will be downloaded.
HTTP/HTTPS User Name	The user name for the HTTP/HTTPS server.
HTTP/HTTPS Password	The password for the HTTP/HTTPS server.

Table 48: Network Upgrade Configuration

Please follow the steps below to upgrade the firmware remotely.

1. Enter the firmware server path under Web GUI→**Maintenance**→**Upgrade**.
2. Click on “Save”. Then reboot the device to start the upgrading process.
3. Please be patient during the upgrading process. Once done, a reboot message will be displayed in the LCD.
4. Manually reboot the GXW450X when it’s appropriate to avoid immediate service interruption. After it boots up, log in to the Web GUI to check firmware version.

Upgrading via Local Upload

If there is no HTTP/TFTP server, users could also upload the firmware to the GXW450X directly via Web GUI. Please follow the steps below to upload firmware locally.

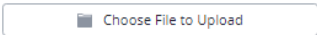
1. Download the latest GXW450X firmware file from the following link and save it on your PC: <https://www.grandstream.com/support/firmware>
2. Log in to the Web GUI as an administrator on the PC.
3. Go to Web GUI→**Maintenance**→**Upgrade**, upload the firmware file by clicking on  and select the firmware from your PC. The default firmware file name is *gxw4500fw.bin*

The screenshot shows a web interface titled "Upgrade Firmware". It contains several input fields and a button:

- Upgrade Via:** A dropdown menu with "HTTP" selected.
- Firmware Server Path:** A text input field containing "fw.ipvideotalk.com/gs". To its right, a status indicator says "Upgrading firmware..." with a circular arrow icon.
- Firmware File Prefix:** An empty text input field.
- Firmware File Suffix:** An empty text input field.
- HTTP/HTTPS Username:** An empty text input field.
- HTTP/HTTPS Password:** An empty text input field.
- Firmware File Path:** A button with a folder icon and the text "Choose File to Upload".

Figure 77: Upgrading Firmware Files

4. Wait until the upgrading process is successful and a window will be popped up in the Web GUI requesting to confirm the reboot of the GXW450X and the changes to take effect.
5. Click on "OK" to reboot the GXW450X and check the firmware version after it boots up.
 - o Please do not interrupt or power cycle the GXW450X during the upgrading process.
 - o The firmware file name allows the use of the special characters besides the following restricted characters: # \$ ^ & * + () [] / ; ' | , < > ?

Upgrading via a Local Server

Users can download a free TFTP, FTP, or HTTP server and conduct a local firmware upgrade. A free window version TFTP server is available for download from:

http://www.solarwinds.com/products/freetools/free_tftp_server.aspx

<http://tftpd32.jounin.net>

Please check our website at <https://www.grandstream.com/support/firmware> for the latest firmware.

Instructions for local firmware upgrade via TFTP:

1. Unzip the firmware files and put all of them in the root directory of the TFTP server;
2. Connect the PC running the TFTP server and the GXW450X to the same LAN segment;
3. Launch the TFTP server and go to the File menu → Configure → Security to change the TFTP server's default setting from "Receive Only" to "Transfer Only" for the firmware upgrade;
4. Start the TFTP server and configure the TFTP server in the GXW450X web configuration interface;
5. Configure the Firmware Server Path to the IP address of the PC;
6. Update the changes and reboot the GXW450X.

End users can also choose to download a free HTTP server from <http://httpd.apache.org/> or use

Microsoft IIS web server.

No Local Firmware Server

For users that would like to use remote upgrading without a local TFTP/FTP/HTTP server, Grandstream offers a NAT-friendly HTTP server. This enables users to download the latest software upgrades for the gateway via this server. Please refer to the following webpage for the firmware server path to use:

<https://www.grandstream.com/support/firmware>

Backup

The GXW450X configuration can be backed up locally or via the network. The backup file will be used to restore the configuration on GXW450X when necessary.

Backup/Restore

Users could back up the GXW450X configurations for restore purposes under Web GUI → **Maintenance** → **Backup** → **Backup/Restore**. Click on **Add Backup** to create a new backup. Then the following dialog will show:

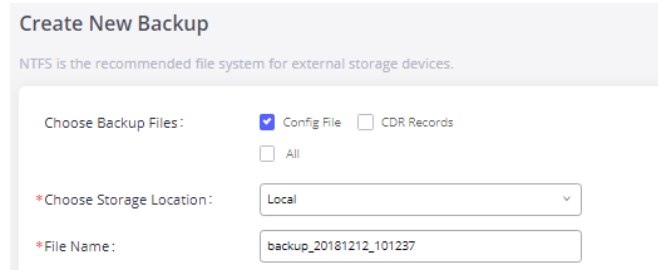

Create New Backup

NTFS is the recommended file system for external storage devices.

Choose Backup Files: Config File CDR Records
 All

*Choose Storage Location: Local

*File Name: backup_20181212_101237

Figure 78: Create New Backup

1. Choose the files to be included in the backup.
2. Choose where to store the backup file: USB Disk, SD Card, or Local.
3. Name the backup file.
4. Click on "Backup" to start the backup.

Once the backup is done, the list of the backups will be displayed with the date and time on the web page. Users can download, restore, or delete it from the GXW450X internal storage or the external device.

Click on **Upload Backup File** to upload backup file from the local device to GXW450X. The uploaded backup file will also be displayed in the web page and can be used to restore the GXW450X.

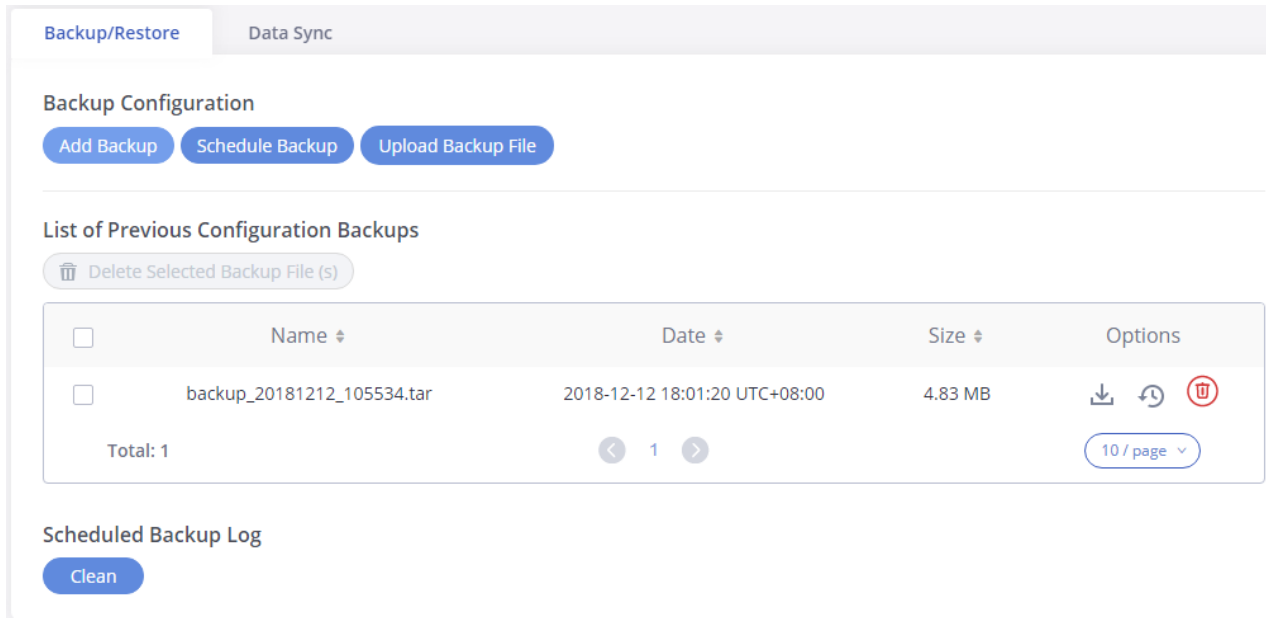

Backup/Restore | Data Sync

Backup Configuration

Add Backup **Schedule Backup** **Upload Backup File**

List of Previous Configuration Backups

Delete Selected Backup File (s)

<input type="checkbox"/>	Name	Date	Size	Options
<input type="checkbox"/>	backup_20181212_105534.tar	2018-12-12 18:01:20 UTC+08:00	4.83 MB	

Total: 1

Scheduled Backup Log

Clean

Figure 79: Backup / Restore

The **Schedule Backup** option allows GXW450X to perform automatic backup at the user-specified time. Scheduled backup files can only be stored on a USB / SD card / SFTP server. Users can set backup time from 0-23 and how frequently the backup will be performed.

Schedule Backup

NTFS is the recommended file system for external storage devices.

Enable Scheduled

Backup:

Choose Backup Files: Config File CDR Records
 All

Choose Storage: SFTP Server ▾

Location:

*Account:

Password:

*Server Address:

Destination Directory:

*Backup Time:

*Backup Frequency:

[+ Test Connection](#)

Figure 80: Schedule Backup

Data Sync

Besides local backup, users could backup the voice records and/or CDR on a daily basis to a remote server via SFTP protocol automatically under GUI→Maintenance→Backup→Data Sync.

The client account supports special characters such as @ or ".". This change allows users to use an email address as SFTP accounts. It allows users to specify the destination directory on the SFTP server for the backup files. If the directory doesn't exist on the destination, GXW450X will create the directory automatically.

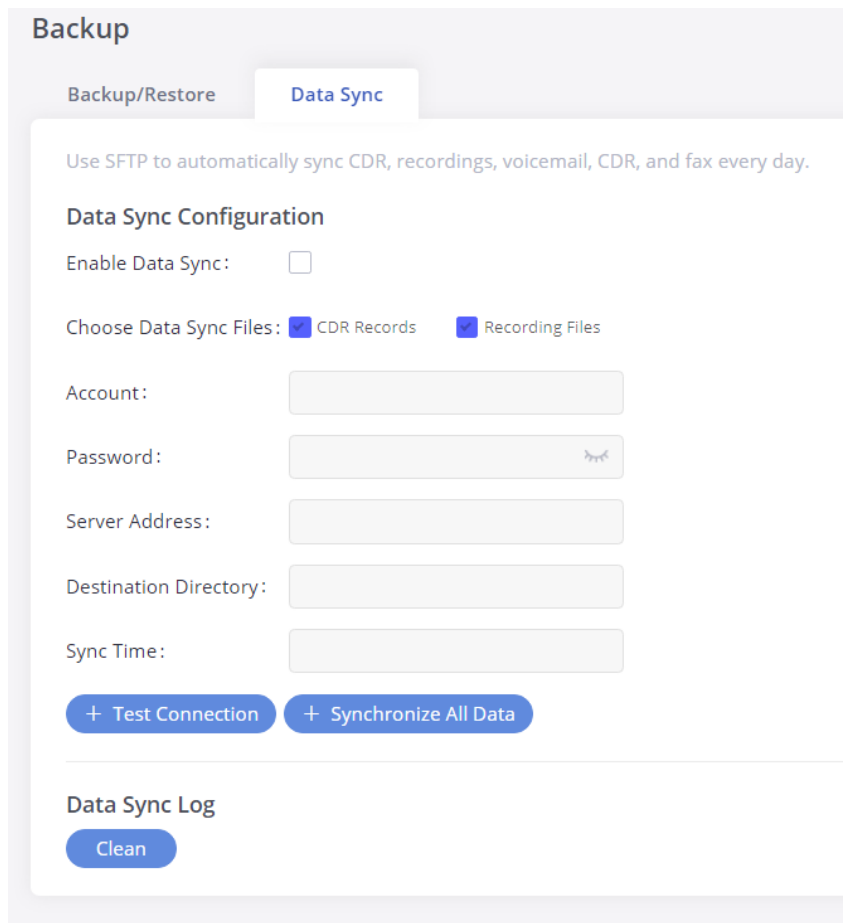

Figure 81: Data Sync

Enable Data Sync	Enable the auto backup function. This option is disabled by default
Choose Data Sync Files	Choose the files to sync
Account	Enter the Account name on the SFTP backup server.
Password	Enter the Password associate with the Account on the SFTP backup server.
Server Address	Enter the SFTP server address.
Destination Directory	Specify the directory in the SFTP server to keep the backup file. Format: 'xxx/xxx/xxx', If this directory does not exist, GXW will create this directory automatically.
Sync Time	Enter 0-23 to specify the backup hour of the day.



Table 49: Data Sync Configuration

Before saving the configuration, users could click on "Test Connection". The GXW450X will then try connecting the server to make sure the server is correct and accessible for the GXW450X.

Save the changes and all the backup logs will be listed on the web page.

Restore Configuration from Backup File

To restore the configuration on the GXW450X from a backup file, users could go to Web GUI → **Maintenance** → **Backup** → **Backup/Restore**.

- A list of previous configuration backups is displayed on the web page. Users could click on  of the desired backup file and it will be restore the GXW450X.
- If users have other backup files on the PC to restore on the GXW450X, click on "Upload Backup File" first and select it from the local PC to upl the GXW450X. Once the uploading is done, this backup file will be displayed in the list of previous configuration backups for restoring purpos Click on  to restore from the backup file.
- Users could also restore using the backup file saved on an SD card or USB device plugged into the GXW450X.

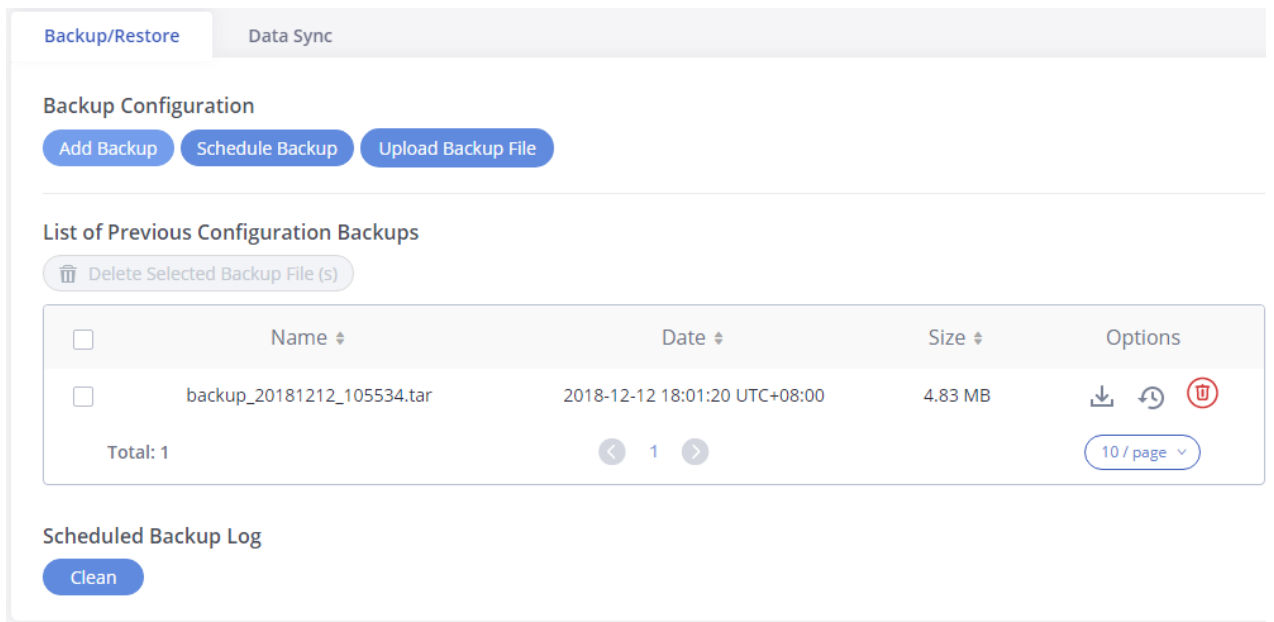

Figure 82: Restore GXW450X from Backup File

Backup file must be in tar format and contain letters, digits or special characters -_. The file size must be less than 10MB.

System Cleanup/Reset

Reset & Reboot

Users could perform reset and reboot under Web GUI→**Maintenance**→**System Cleanup/Reset**→**Reset & Reboot**. To factory reset the device, set mode type first. There are two different types of reset.

- **User Data:** The data such as CDR Records Operation Logs Core file etc.
- **All:** Restore the device to factory default settings for both User Data and User Configuration.

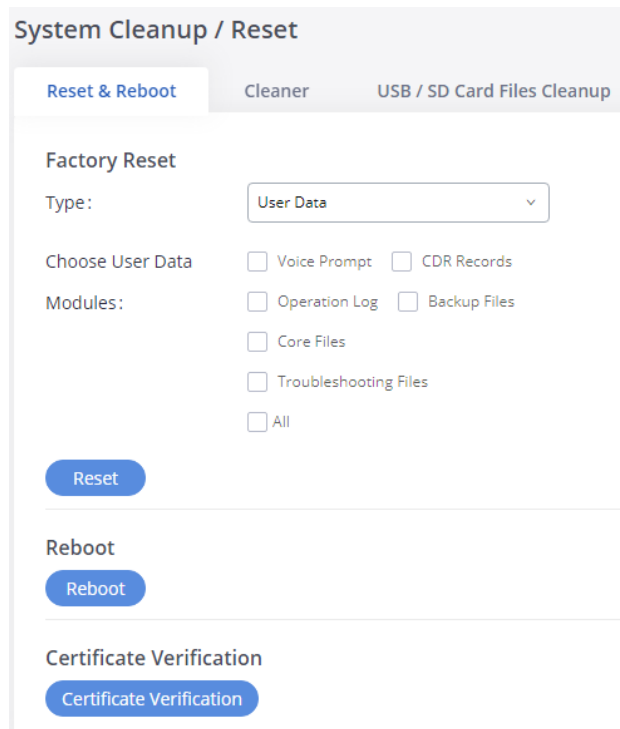

Figure 83: Reset and Reboot

- Press **Reset** to factory reset the GXW450X.
- Press **Reboot** to reboot the unit.
- Press **Certificate Verification** to validate certificate chain for the server's certificate.

Cleaner

Users could configure to clean the Call Detail Report/Voice Records/Voice Mails/FAX automatically under Web GUI→ **Maintenance**→**System Cleanup/Reset** →**Cleaner**.

System Cleanup / Reset

Reset & Reboot | **Cleaner** | USB / SD Card Files Cleanup

Clean CDR, recordings, voicemail, and fax automatically.

CDR Cleaner

Enable CDR Cleaner:

*CDR Clean Time:

*Clean Interval:

File Cleaner

Enable File Cleaner:

Clean Files in External Storage:

Choose Cleaner Files: Backup Files

*File Clean Threshold:

*File Clean Time:

*File Clean Interval:

Cleaner Log

Figure 84: Cleaner

CDR Cleaner	
Enable CDR Cleaner	Enable the CDR Cleaner function.
CDR Clean Time	Enter 0-23 to specify the hour of the day to clean up CDR.
Clean Interval	Enter 1-30 to specify the day of the month to clean up CDR.
File Cleaner	
Enable File Cleaner	Enter the Voice Records Cleaner function.
Clean Files in External Device	If enabled the files in an external device (USB/SD card) will be atomically cleaned up as configured.
Choose Cleaner File	Select the files for system automatic clean.
File Clean Threshold	Specify the threshold of local storage usage from 0 to 99 (in percentage).
File Clean Time	Enter 0-23 to specify the hour of the day to clean up the files.
File Clean Interval	Enter 1-30 to specify the day of the month to clean up the files.
Cleaner Log	Press the "Clean" button to clean the cleaner log.

Table 50: Cleaner Configuration

All the cleaner logs will be listed on the bottom of the page.

USB/SD Card Files Cleanup

Users could manage the content of the external drives, USB and /or SD card, manually from the Web GUI under **Maintenance**→**System Cleanup**→**USB / SD Card Files Cleanup**.

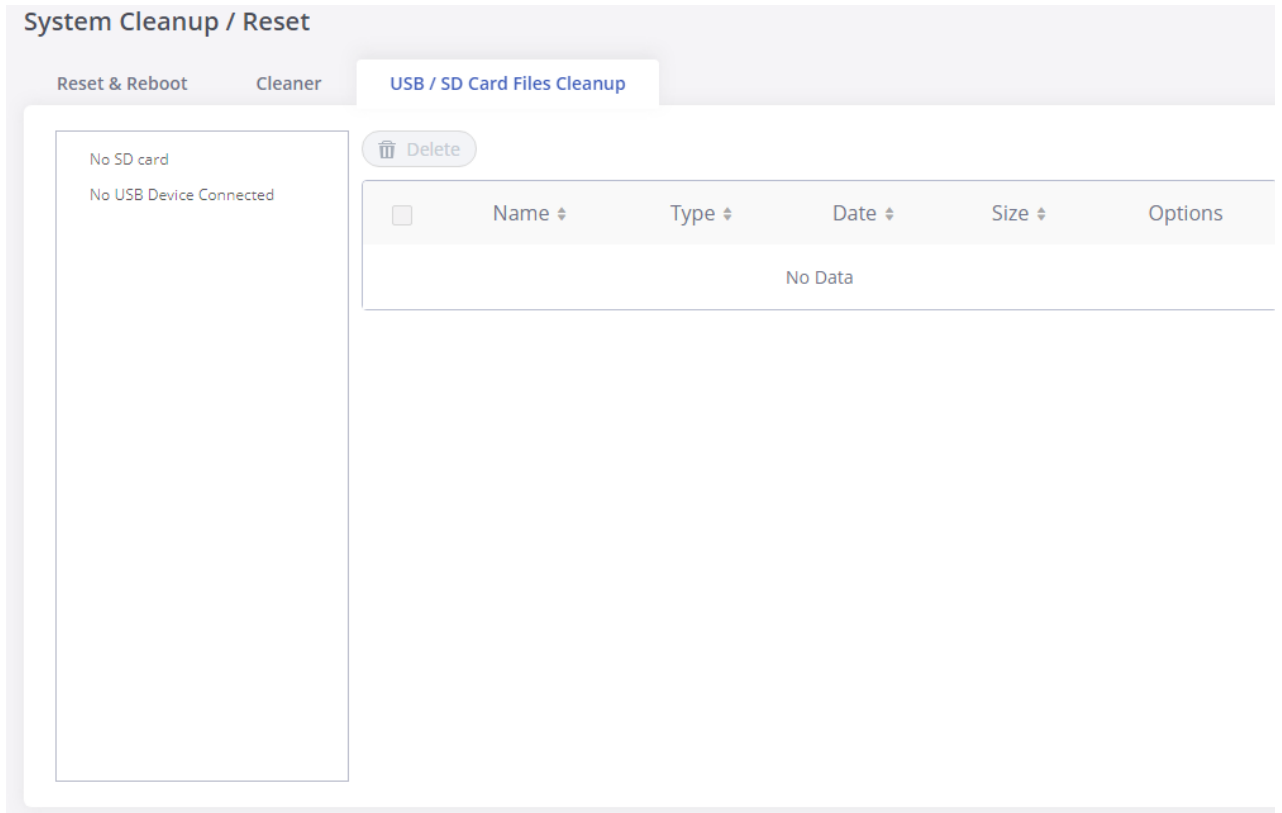

Figure 85: SB/SD Card Files Cleanup

On this Web page, users could navigate through the paths and the directories of the USB and/or the SD card and select the files and folders to cle

Network Troubleshooting

On the GXW450X, users could capture traces, ping remote host and traceroute remote host for troubleshooting purposes under Web GUI→**Maintenance**→**Network Troubleshooting**.

Ethernet Capture

An ethernet trace can be captured for troubleshooting purposes related to network issues, the SIP flow, etc.

The captured trace can be downloaded for analysis. Instructions or results will be displayed in the Web GUI output result.

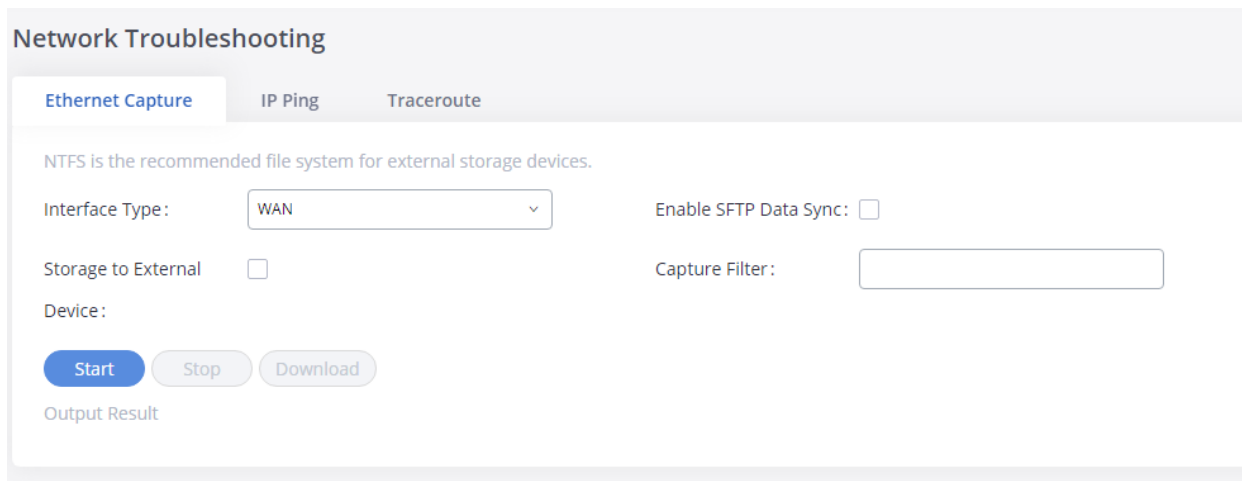

Figure 86: Ethernet Capture

Interface Type	Select the network interface to monitor. <ul style="list-style-type: none"> o WAN o LAN o Both The default is "WAN".
Enable SFTP Data Sync	Check this box to save the capture files in the SFTP server. Please make sure the configuration of data synchronization works in advance.
Storage to External Device	Check this box to activate storage of the capture either on the USB or SD Card.
Capture Filter	Enter the filter to obtain the specific types of traffic, such as (host, src, dst, net, proto...).
Start	Click to start the trace.
Stop	Click to stop the trace.
Download	Click to download the trace if the trace is stored locally.

Table 51: Ethernet Capture Parameters

The output result is in .pcap format. Therefore, users could specify the capture filter as used in the general network traffic capture tool (host, src, d protocol, port, port range) before starting to capture the trace.

IP Ping

Enter the Target Host using either a hostname or an IP address. Then press the "Start" button. The output result will dynamically be displayed in th window below.

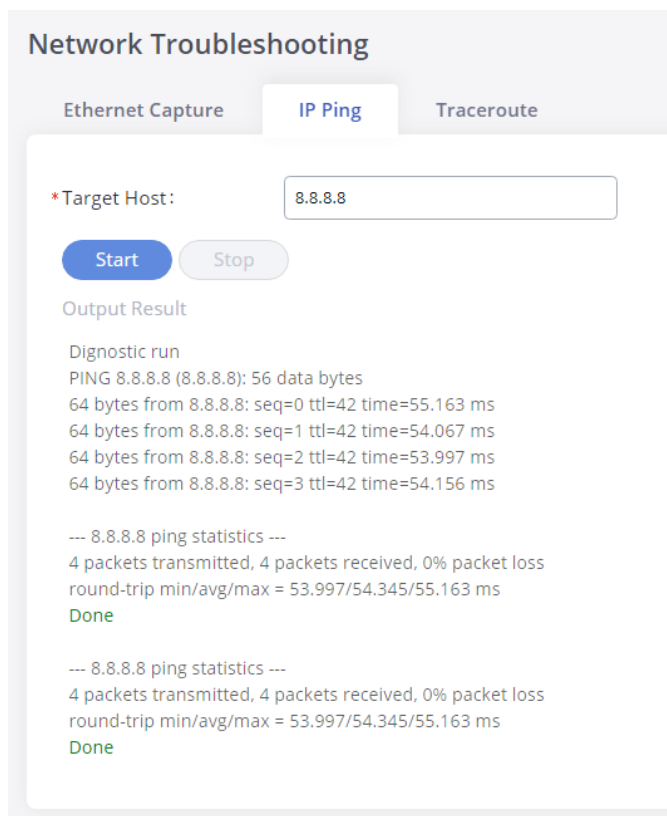

Figure 87: IP Ping

Traceroute

Enter the target host in hostname or IP address. Then press the "Start" button. The output result will dynamically be displayed in the window below.

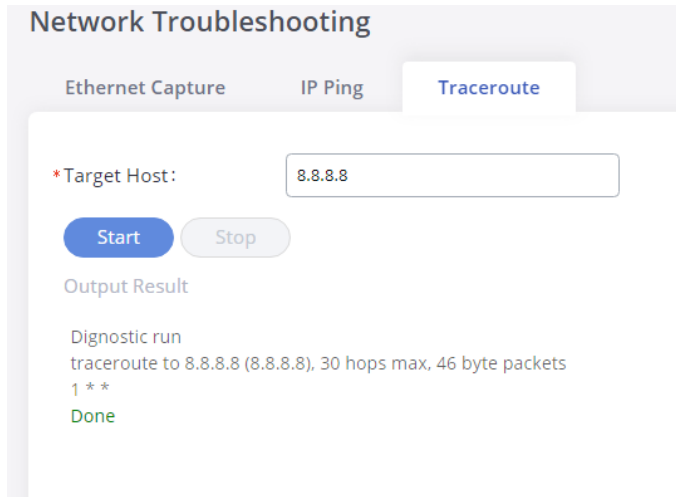

Figure 88: Traceroute

Signaling Troubleshooting

Please refer to the [Digital Trunk Troubleshooting] section.

Service Check

Enable Service Check to periodically check the GXW450X responsiveness. Check Cycle is configurable in seconds and the default setting is 60 sec. Times is the maximum number of failed checks before restarting the GXW450X. The default setting is 3. If there is no response from GXW450X after attempts (default) to check, the current status will be stored and GXW450X will be restarted.

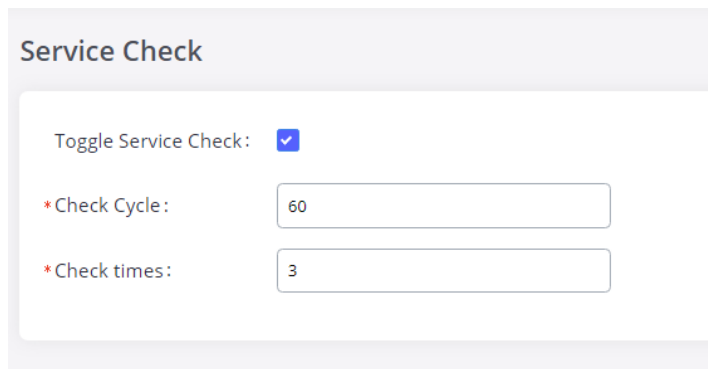

Figure 89: Service Check

CDR (CALL DETAIL RECORD)

CDR (Call Detail Record) is a data record generated by the PBX that contains attributes specific to a single instance of a phone call handled by the system. It has several data fields to provide a detailed description of the call, such as the phone number of the calling party, phone number of the receiving party, start time, call duration, etc.

CDR Filter

On the GXW450X, the CDR can be accessed under Web GUI → CDR → CDR. Users could filter the call report by clicking on a "Filter" dropdown menu and specifying a date range and criteria, depending on how the users would like to include the logs in the report. Click on the "Search" button to display the generated report.

CDR

By default, this page displays the CDR entries from the current month. Use the "Filter" button to specify a time range.

Caller Number:
 Callee Number:

Source Trunk Name:
 Destination Trunk Name:

Time: -

Status:
 Answered
 No Answer
 Busy
 Failed

Status	Call from	Call to	Start Time	Call Time	Talk Time
	"3100" 3100 [Trunk: Digital_1]	21007 [Trunk: sip147]	2018-11-13 18:52:14	14:09:17	14:09:15
	"3100" 3100 [Trunk: Digital_1]	21006 [Trunk: sip147]	2018-11-13 18:51:52	0:00:09	0:00:05
	"3100" 3100 [Trunk: Digital_1]	21007 [Trunk: sip147]	2018-11-13 18:51:03	0:00:36	0:00:22

Figure 90: CDR Filter

Caller Number	<p>You can specify a caller number or set a caller number with a pattern (. match zero or more characters only appears in the end. X any digit from 0-9, case-insensitive, repeatable, and only appears in the end. If the pattern string contains "." in the end, "X" must appear before ".").</p> <p>For Example:</p> <ul style="list-style-type: none"> o X: It will filter out CDR records where a caller number is of ranges from 0 to 9. o XXXX: It will filter out CDR records where a caller number has 4 digits. o 3XXX: It will filter out CDR records where a caller number has a leading digit of 3 and a length of 4 digits. o 3.: It will filter out CDR records where a caller number has a leading digit 3.
Callee Number	Enter the caller name to filter the CDR report. CDR with the matching caller name will be filtered out.
Source Trunk Name	Select source trunk(s) and the CDR of calls going through inbound trunk(s) will be filtered out.
Destination Trunk Name	Select destination trunk(s) and the CDR of calls going outbound through the trunk(s) will be filtered out.
Time	Specify the start time and the end time to filter the CDR report. Click on the calendar icon on the right and the calendar will show users to select the exact date and time.
Status	<p>Filter with the call status, the available statuses are the following:</p> <ul style="list-style-type: none"> o Answered o No Answer o Busy o Failed

Table 52: CDR Filter parameters

The call report will display as the following figure shows.



Status ↕	Call from ↕	Call to ↕	Start Time ↕	Call Time ↕	Talk Time ↕
	"3100" 3100 [Trunk: Digital_1]	21007 [Trunk: sip147]	2018-11-13 18:52:14	14:09:17	14:09:15
	"3100" 3100 [Trunk: Digital_1]	21006 [Trunk: sip147]	2018-11-13 18:51:52	0:00:09	0:00:05
	"3100" 3100 [Trunk: Digital_1]	21007 [Trunk: sip147]	2018-11-13 18:51:03	0:00:36	0:00:22
	"1007" 1007 [Trunk: sip147]	41000 [Trunk: Digital_1]	2018-11-13 15:29:57	0:00:26	0:00:07
	"1007" 1007 [Trunk: sip147]	41000 [Trunk: Digital_1]	2018-11-13 15:28:31	0:00:08	0:00:00

Figure 91: Call Report

The CDR report has the following data fields:

- **Status**

Answered, Busy, No answer, or Failed.

- **Call From**

Example format: "3100" 3100 [Trunk: Digital_1]

- **Call To**

Example format: 21007 [Trunk: sip147]

- **Start Time**

Example Format: 2018-11-13 18:52:14

- **Call Time**

Example Format: 0:00:08

- **Talk Time**

Example Format: 0:00:07

CDR Report Operations

After applying the filter, Users could perform the following operations on the CDR report:

- **Sort by data field**

Click on the header of the data field column to sort the report according to an ascending or descending order. Clicking on the same header again reverse the order.

- **Download the search result**

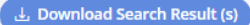
Click on  to export the records filtered out to a .csv file.

- **Delete search result**

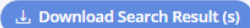
On the bottom of the page, click on  button to remove CDR records that appear on search results.

- **Delete all records**

Click on  button to remove all the call report information.

- **Download all records.**

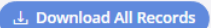
Click on  to export all the records to a .csv file.

Automatic Download

Users could configure the GXW450X to automatically download the CDR records and send the records to an Email address. Click on "Automatic Download Settings" and configure the parameters in the dialog below.

Automatic Download

[Save](#)[Cancel](#)

Automatically send the new CDR records to the configured Email at a certain period. If you want to upload the CDR records to an FTP/TFTP server, please go to the [Data Sync](#) page to configure.

Automatic Download:

Delete Sent Records:

Automatic Download

Period:

Email: [Email Template](#)

Figure 92: Automatic CDR Download

To receive CDR records automatically from Email, check "Enable" and select a time period "By Day" "By Week" or "By Month", and select Hour of the day as well for the automatic download period. Make sure you have entered an Email or multiple email addresses where to receive the CDR records.

Users have the option to delete the sent records "Delete Sent Records".

CDR Report Data Fields

The CSV CDR report file downloaded will have the following data fields.

Field	Type	Description
Account Code	String	An account code associated with the Party A channel.
Caller Number	String	The Caller ID number.
Callee Number	String	The destination number.
Context	String	The context of the call.
CallerID	String	The caller ID.
Source Channel	String	The name of the source channel.
Dest Channel	String	The name of the destination channel.
Lastapp	String	The last application the Party A channel executed.
Lastdata	String	The application data for the last application the Party A channel executed.
Start time	Date/time	The time the CDR was created.
Answer Time	Date/time	The time when Party A was answered, or when the bridge between Party A and Party B was created.
End time	Date/time	The time when the CDR was finished. This occurs when either party hangs up, or when the bridge between the parties is broken.
Call time	Integer	The time in seconds from start time until the end time.
Talk time	Integer	The time in seconds from answer time until the end time.

Field	Type	Description
Disposition	Enum	The final known disposition of the CDR record. The possible values are: "ANSWERED", "NO ANSWER, CONGESTION, FAILED, and BUSY.
Amaflags	Enum	A flag is specified on the Party A channel. The possible values are: "OMIT, BILLING, and DOCUMENTATION.
Uniqueid	String	A unique identifier for the Party A channel
Userfield	String	A user-defined field set on the channels. If set on both the Party A and Party B channels, the user fields of both are concatenated and separated by a comma.
Dest Channel Extension	String	The destination extension of the call
Caller Name	String	The name of the caller
Answer by	String	The extension to be called
Session	String	A numeric value that, combined with uniqueid and linkedid, can be used to uniquely identify a single CDR record
Action Owner	String	The party that made the call
Action Type	String	The action type of the call
Source Trunk Name	String	The inbound route trunk name
Dest Trunk Name	String	The outbound route trunk name

Table 53: CDR Report Data Fields

Example of a CDR report Data fields:

- o **Account code:** —
- o **Caller Number:** 1008
- o **Callee number:** 1006
- o **Context:** did-out
- o **Caller ID:** "" <1008>
- o **Source Channel:** DAHDI/i1-1-1
- o **Dest Channel:** PJSIP/trunk_5-00000000
- o **Lastapp:** Dial
- o **Lastdata:** PJSIP/1006@trunk_5,,b(callee-handler^s^1)
- o **Start time:** 11/13/2018 3:01:28 PM
- o **Answer time:** 11/13/2018 3:01:31 PM
- o **End time:** 11/13/2018 3:01:50 PM
- o **Call time:** 22 (in seconds)
- o **Talk Time:** 18
- o **Disposition:** ANSWERED
- o **Amaflags:** DOCUMENTATION
- o **UniqueID:** 1542092488
- o **Userfield:** External
- o **Dest channel extension:** trunk_5
- o **Caller name:** –

- **Answer by:** trunk_5
- **Session:** 1542092488529109-1008
- **Action owner:** 1008
- **Action type:** DIAL.
- **Source Trunk name:** Digital_1
- **Dest Trunk name:** sip147

CHANGE LOG

This section documents significant changes from previous versions of GXW450X user manuals. Only major new features or major document updates listed here. Minor updates for corrections or editing are not documented here.

Firmware version 1.0.1.11

- Added new option "Original Called" when using SS7 signaling type. [[Original Called](#)]
- Added support for "early ACM" in SS7 interface settings. [[Early ACM](#)]
- Added new option PROGRESS to the Edit Digital Port. [[PROGRESS](#)]
- Added auth-user and auth-pass parameter support in OpenVPN. [[User authentication](#)]
- Added ability to provision TR-069 settings. [[TR-069](#)]
- Firewall rules will now apply to traffic between LAN and WAN interfaces. [[Static Defense](#)]
- Added E1/T1/J1 Error Code option to allow users to send either 480 or 503 response to the VoIP trunk when the E1/T1/J1 interface is down or unavailable. [[E1/T1/J1 Error Code](#)]

Firmware version 1.0.1.9

- No major changes

Firmware version 1.0.1.7

- Added the ability to customize call failure tone settings. [[Call Failure Tone Settings](#)]
- Added ability to group E1 lines with a single DATA channel. [[Data channel](#)]
- Added the ability to assign channel groups. [[Digital Hardware Configuration](#)]
- Added T1 E&M signaling support. [[Table 30: Digital Hardware Configuration Parameters: T1 – E&M Immediate](#)]
- Added Secondary SIP Server option to Register SIP Trunks. [[Secondary SIP Server](#)]
- Added Secondary Outbound Proxy option. [[Backup Outbound Proxy](#)]
- The administrator-level users can now view the SNMP page. [[SNMP](#)]
- Added GDMS support.

Firmware version 1.0.0.35

- Added ability to select a different E1/T1 port to use for the line's data channel when SS7 is selected as the signaling type. [[Data channel](#)]
- Added ability to select the minimum and maximum TLS versions to support. [[TLS Security](#)]
- Added SNMP support. [[SNMP](#)]
- Added options From User, Send PPI Header, PPI Mode, and DOD as From Name. [[Table 33: VoIP Trunk Configuration Parameters – Register SIP](#)]
[[Table 34: VoIP Trunk Configuration Parameters – Peer SIP Trunk](#)]

Firmware version 1.0.0.29

- Added the ability to configure tone region. [[Tone Region](#)]
- Added the ability to configure DODs for VoIP trunks. [[Direct Outward Dialing \(DOD\)](#)]

Firmware version 1.0.0.27

- Added GAPS provisioning support.
- Added the Set Caller ID option to the Edit Inbound Rule page. [[Set Caller ID Info](#)]
- Added the Enable Filter on Source Caller ID option to the Edit Outbound Rule page. This option will allow only callers with the specified CID to use the outbound route. [[Enable Filter on Source Caller ID](#)]

Firmware version 1.0.0.24

- No major changes.

Firmware version 1.0.0.22

- No major changes.

Firmware version 1.0.0.20

- No major changes.

Firmware version 1.0.0.18

- This is the initial version.

Need Support?

Can't find the answer you're looking for? Don't worry we're here to help!

[CONTACT SUPPORT](#)