

## DS-2CE50D8T-VPIT5ZE#UK 2MP Varifocal Dome Camera



- High quality imaging with 2 MP, 1920 × 1080 resolution
- Clear imaging against strong back light due to 130 dB true WDR technology
- 3D DNR technology delivers clean and sharp images
- 2.8 mm to 12 mm motorized varifocal lens
- Up to 60 m IR distance for bright night imaging
- High quality audio with audio over coaxial cable, built-in mic
- Water and dust resistant (IP67) and vandal resistant (IK10)

## ▪ Specification

Camera	
Image Sensor	2 MP CMOS
Max. Resolution	1920 (H) × 1080 (V)
Min. Illumination	0.0005 Lux @ (F1.28, AGC ON)
Day & Night	ICR
Angle Adjustment	Pan: 0 to 355°, Tilt: 0 to 75°, Rotation: 0 to 355°
Signal System	PAL/NTSC
Shutter Time	PAL: 1/25 s to 1/50,000 s; NTSC: 1/30 s to 1/50,000 s
Lens	
Lens Type	2.8 mm to 12 mm motorized
Focal Length & FOV	Horizontal FOV: 106° to 32°, vertical FOV: 56° to 18°, diagonal FOV: 127° to 37°
Lens Mount	Φ14
Illuminator	
Supplement Light Type	IR
Supplement Light Range	IR: Up to 60 m
Smart Supplement Light	Yes
Image	
Image Parameters Switch	STD/HIGH-SAT
Image Settings	Brightness, Contrast, Sharpness, Anti-banding, AGC
Frame Rate	TVI: 1080p @30 fps, 1080p @25 fps
Day/Night Mode	Auto
Wide Dynamic Range (WDR)	≥130 dB
Image Enhancement	WDR, BLC, HLC, Global, HLS
Privacy Mask	4 programmable privacy masks
Noise Reduction	3D DNR
White Balance	Auto, Manual
Interface	
Video Output	1 HD analog output
Built-in Microphone	Yes
Event	
Motion Detection	4 programmable motion areas
General	
Power	12 VDC±25%/PoC.at, Max. 7.4 W *You are recommended to use one power adapter to supply the power for one camera.
Material	Metal
Dimension	∅121.5 mm × 97.6 mm (∅4.78" × 3.84")
Weight	Approx. 570 g (1.26 lb.)
Operating Condition	-40 °C to 60 °C (-40 °F to 140 °F). Humidity 90% or less (non-condensing)
Communication	HIKVISION-C
Language	English
Approval	
Protection	IP67, IK10

▪ **Available Model**





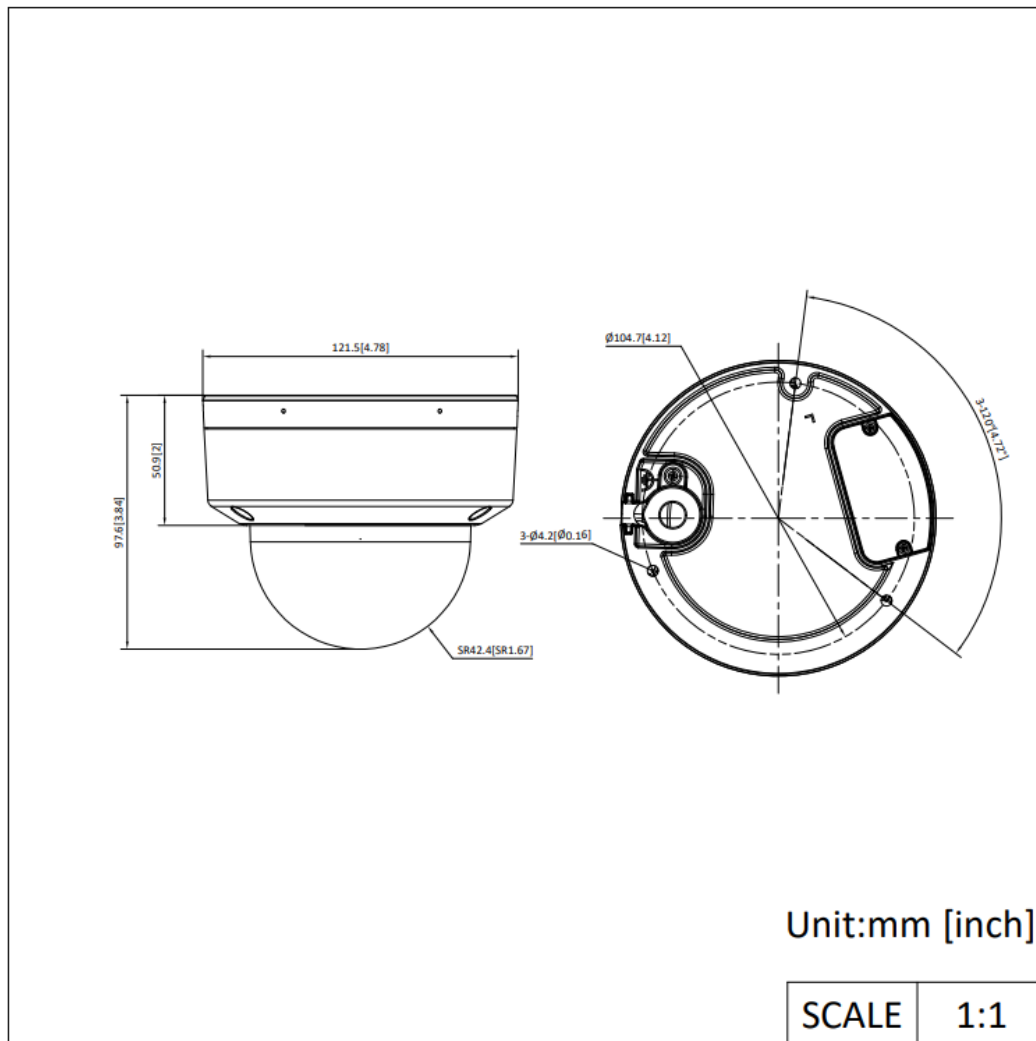











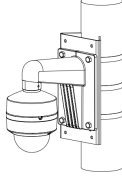
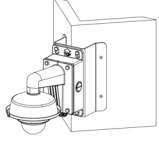

DS-2CE50D8T-VPITSZE(2.8-12mm)(Europe)

▪ **Dimension**

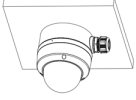
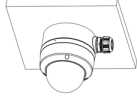

▪ **Accessory**

▪ **Optional**

<b>DS-1272ZJ-120</b> <b>Wall mount</b>	<b>DS-1272ZJ-120B</b> <b>Wall mount</b>	<b>DS-1271ZJ-120</b> <b>Pendant Mount</b>	<b>DS-1275ZJ-SUS</b> <b>Vertical pole mount</b>	<b>DS-1276ZJ-SUS</b> <b>Corner mount</b>
				
				
<b>DS-1280ZJ-DM46</b> <b>Junction box</b>	<b>DS-2280ZJ-WA120</b> <b>Junction box</b>	<b>DS-2210ZJ-WA-120</b> <b>Pendant Mount</b>	<b>DS-2200ZJ-WA-120</b> <b>Wall mount</b>	<b>DS-2200ZJ-WAJ-120</b> <b>Wall mount</b>
				
				



**Headquarters**

No.555 Qianmo Road, Binjiang District,  
Hangzhou 310051, China  
T +86-571-8807-5998  
www.hikvision.com



Follow us on social media to get the latest product and solution information.

