

2MP Starlight Laser IR Network PTZ Dome Camera

IPC6252SL-X33UP



Key Features

Optics

- Starlight illumination
- 33x optical zoom
- Accurate and fast focusing
- IR anti-reflection window to increase the infrared transmittance
- Optical glass window with higher light transmittance
- Smart IR, 30m(98ft) IR distance
- Vari-focal laser: 30m to 500m(1640ft) distance, proportional to optical zoom of camera module

Compression

- Ultra 265, H.265, H.264, MJPEG
- Embedded smart algorithm
- Triple streams
- Customized OSD

Network

- ONVIF Conformance

Structure

- Special structure and window design to battle bad weather (especially in dusty weather)
- Innovative snow-removing functionality
- Intelligent temperature control technology
- More effective heat dissipation system
- 6 KV surge protection designed for network interface

Specifications

IPC6252SL-X33UP	
Camera	
Sensor	1/2.8" , progressive scan,2.0 megapixel, CMOS
Lens	4.5 ~ 148.5 mm (33x optical zoom), AF automatic focusing and motorized zoom lens
Angle of View(H)	62.93° (wide)~3.67° (tele)
Shutter	Auto/Manual, shutter time: 1/6 s ~ 1/100000 s
Minimum Illumination	Colour: 0.001 lux (F1.6, AGC ON) 0 lux with IR
Iris	Auto/Manual, F1.6 ~ F5.3
Day/Night	IR-cut filter with auto switch (ICR)
Digital noise reduction	2D/3D DNR
S/N	>52dB
VF laser	Up to 500m(1640 ft)
Defog	Digital Defog
WDR	120dB
Video	
Video Compression	Ultra 265,H.265, H.264, MJPEG
H.264 code profile	Baseline profile, Main Profile, High Profile
Frame Rate	Main Stream:2MP (1920×1080):Max. 60 fps; Sub Stream:2MP (1920×1080):Max. 60 fps; Third Stream: D1 (720×576): Max. 60 fps
HLC	Supported
BLC	Supported
EIS	Supported
OSD	Up to 8 OSDs
Privacy Mask	Up to 8 areas
ROI	Up to 8 areas
Motion Detection	Up to 4 areas
Smart	
Behavior Detection	Intrusion, cross line, motion detection, Auto tracking
Exception Detection	Audio detection
Intelligent Identification	Face detection

Statistical Analysis	People counting
General Function	Watermark, IP Address Filtering, Tampering Alarm, Alarm input, Alarm output, Access Policy, ARP Protection, RTSP Authentication, User Authentication
Audio	
Audio Compression	G.711
Two-way Audio	Supported
Suppression	Supported
Sampling Rate	8 KHZ
Storage	
Edge Storage	Micro SD, up to 128 GB
Network Storage	ANR
Network	
Protocols	IPv4, IGMP, ICMP, ARP, TCP, UDP, DHCP, PPPoE, RTP, RTSP, RTCP, DNS, DDNS, NTP, FTP, UPnP, HTTP, HTTPS, SMTP, 802.1x, SNMP
Compatible Integration	ONVIF(Profile S, Profile G), API
Pan & Tilt	
Pan Range	360°
Pan Speed	0.1°/s ~ 240°/s
	Preset speed: 300°/s
Tilt Range	-15° ~ +90° (auto reverse)
Tilt Speed	0.1° ~ 160°/s
	Preset speed: 240°/s
Number of Presets	1024
Patrol	Preset patrol, route patrol, recorded patrol
Home Position	Supported
Interface	
Audio I/O	Audio interface
	1 Input: impedance 35 kΩ; amplitude 2 V [p-p]
	1 Output: impedance 600 Ω; amplitude 2 V [p-p]
Alarm I/O	1/ 1
Network	1 RJ45 10M/100M Base-TX adaptive Ethernet network interface
General	
Power	24 V AC±25% (default power supply), 24V DC±25%, PoE (PSE Required)
	Power consumption: 8 W ~ 47 W
Dimensions (∅ x H)	∅227 mm x 359.4 mm (∅8.9" x 14.2")
Weight	5.6 kg (12.3 lb)
Working Environment	-40°C ~ +70°C (-40°F ~ 158°F), Humidity:10%~95% RH(non-condensing)
Ingress Protection	IP66
IR	Built-in VF laser IR
Reset Button	Supported

Dimensions

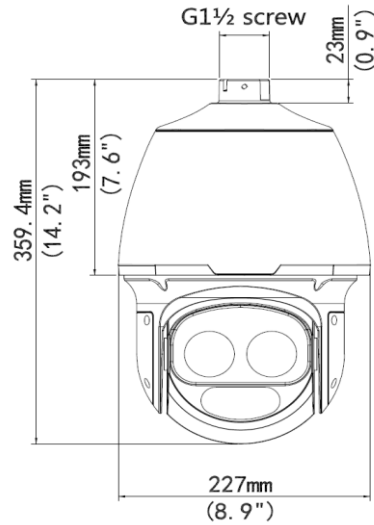

Accessories

Installation mode	Accessories	Description
Pendant mount	TR-CE45-IN bracket	/
	Pendant components: TR-UF45-A-IN ceiling plate TR-SE45-IN pendant rod (200mm) TR-SE45-A-IN pendant rod (500mm)	Ceiling plate is optional with different pendant rod for various applications
Standing pole mount	Customized bracket	The interface is designed with internal G1½ screws. The screw depth must be more than 23 mm.
Wall mount	TR-WE45-IN bracket, TR-WE45-A-INbracket	TR-JB12-INjunction box can be used withTR-WE45-A-IN
Corner mount	TR-WE45-IN bracket +TR-UC08-A/B-IN TR-WE45-A-INbracket +TR-UC08-A/B-IN	
Pole mount	TR-WE45-IN bracket +TR-UP08-A/B-IN TR-WE45-A-INbracket + TR-UP08-A/B-IN	
PoE Power	Accessories	Description
PSE Adapter	PWR-DC5611-P	PSE Adapter (60W) configuration is needed.

Zhejiang Uniview Technologies Co., Ltd.

South Tower, Building 10, Wanlun Science Park, 88 Jiangling Road, Hangzhou, P.R.China 310051

Email: overseasbusiness@uniview.com; globalsupport@uniview.com

<http://www.uniview.com>

©2016 -2017Zhejiang Uniview Technologies Co., Ltd. All rights reserved.

*Product specifications and availability are subject to change without notice.