



CE EMC TEST REPORT

Equipment : apu3c4 system board
Brand Name : PC Engines
Model Name : apu3c4
Applicant : PC Engines GmbH
Flughofstrasse 58, CH-8152 Glattbrugg,
Switzerland
Manufacturer : PC Engines GmbH
Flughofstrasse 58, CH-8152 Glattbrugg,
Switzerland
Standard : EN 55032:2015/AC:2016 Class B
EN 61000-3-2:2014
EN 61000-3-3:2013
EN 55024:2010/A1:2015

The product was received on Apr. 24, 2018, and testing was started from May 03, 2019 and completed on May 08, 2019. We, SPORTON INTERNATIONAL INC. EMC & Wireless Communications Laboratory, would like to declare that the tested sample has been evaluated in accordance with the procedures given in above standards and shown compliance with the applicable technical standards.

The report must not be used by the client to claim product certification, approval, or endorsement by TAF or any agency of government.

The test results in this report apply exclusively to the tested model / sample. Without written approval of SPORTON INTERNATIONAL INC. EMC & Wireless Communications Laboratory, the test report shall not be reproduced except in full.

Approved by: Sin Chang

SPORTON INTERNATIONAL INC. EMC & Wireless Communications Laboratory
No. 52, Huaya 1st Rd., Guishan Dist., Taoyuan City, Taiwan (R.O.C.)



Table of Contents

History of this test report.....	3
Summary of Test Result.....	4
1. General Description of Equipment under Test.....	5
2. Test Configuration of Equipment under Test.....	6
3. General Information of Test.....	10
4. Test of Conducted Emission.....	12
5. Test of Radiated Emission.....	16
6. Harmonics Test.....	23
7. Voltage Fluctuations and Flicker Test.....	24
8. General Performance Criteria Description of Immunity Test.....	25
9. EUT Performance Criteria.....	26
10. Electrostatic Discharge Immunity Test (ESD).....	27
11. Radio Frequency Electromagnetic Field Immunity Test (RS).....	32
12. Electrical Fast Transient/Burst Immunity Test (EFT/BURST).....	34
13. Surge Immunity Test.....	37
14. Conducted Disturbances Induced by Radio-Frequency Field Immunity Test (CS).....	40
15. Power Frequency Magnetic Field Immunity Tests.....	42
16. Voltage Dips and Voltage Interruptions Immunity Tests.....	43
17. List of Measuring Equipment Used.....	44
18. Uncertainty of Test Site.....	48
Appendix A. Test Results of AC Power Port Conducted Emission	
Appendix B. Test Results of Telecommunication Port Conducted Emission	
Appendix C. Test Results of Radiated Emission	
Appendix D. Test Results of Harmonic	
Appendix E. Test Results of Flicker	
Appendix F. Test Results of EMS	
Appendix G. Test Photos	
Photographs of EUT V01	



Summary of Test Result

Report Clause	Ref Std. Clause	Test Standard	Test Items	Result (PASS/FAIL)	Remarks
4	EN55032 Annex A.3	EN 55032:2015/AC:2016	AC Power Port Conducted Emission	PASS	Under limit 15.01 dB at 0.168 MHz
4	EN55032 Annex A.3		Telecommunication Port Conducted Emission	PASS	Under limit 14.02 dB at 0.411 MHz
5	EN55032 Annex A.2		Radiated Emission below 1GHz	PASS	Under limit 3.00 dB at 51.34 MHz
5	EN55032 Annex A.2		Radiated Emission above 1GHz	PASS	Under limit 19.69 dB at 1165.00 MHz
6	-	EN 61000-3-2:2014	Harmonic Current Emission	N/A	Note1
7	-	EN 61000-3-3:2013	Voltage Fluctuations and Flicker	PASS	-
10	EN55024 4.2.1	IEC 61000-4-2:2008	ESD	PASS	-
11	EN55024 4.2.3.2	IEC 61000-4-3:2006/A1:2007/A2:2010	RS	PASS	-
12	EN55024 4.2.2	IEC 61000-4-4:2012	EFT	PASS	-
13	EN55024 4.2.5	IEC 61000-4-5:2014/A1:2017	Surges	PASS	Note2
14	EN55024 4.2.3.3	IEC 61000-4-6:2013	CS	PASS	-
15	EN55024 4.2.4	IEC 61000-4-8:2009	PFMF	PASS	-
16	EN55024 4.2.6	IEC 61000-4-11:2004/A1:2017	Voltage dips and Interruptions	PASS	-

Note1:

The power consumption of EUT is lower than 75W, so the limit is not specified in EN 61000-3-2:2014.

Note2: According to EN 55024 Table 2 description, the surge test of telecommunication/signal cable will be performed only when it's directly connected to outdoor cables; thus, indoor telecommunication/signal port isn't necessary to perform surge test.

Declaration of Conformity:

The test results with all measurement uncertainty excluded are presented in accordance with the regulation limits or requirements declared by manufacturers.

Comments and Explanations:

The test configuration, test mode and test software were written in this test report are declared by the manufacturer.

Reviewed by: Sin Chang

Report Producer: Sandy Chuang



1. General Description of Equipment under Test

Product Detail	
Equipment Name	apu3c4 system board
Model Name	apu3c4
Brand Name	PC Engines
Power Supply	From power adapter

1.1. Feature of Equipment under Test

1. The EUT's highest operating frequency is 1GHz.
2. For a more detailed features description, please refer to the manufacturer's specifications or the User's Manual.



2. Test Configuration of Equipment under Test

2.1. Test Mode

The following table is a list of the test modes shown in this test report.

Conducted Emissions	
USB Port (up) has been evaluated to be the worst case at Radiated Emissions; thus, the measurement for Conducted Emissions will follow this same test configuration.	
Test Mode	Description
1	EUT + USB Port (up) + Adapter

Disturbances at Telecommunication Ports	
USB Port (up) has been evaluated to be the worst case at Radiated Emissions; thus, the measurement for Disturbances at Telecommunication Ports will follow this same test configuration.	
Test Mode	Description
1	EUT + USB Port (up) + Adapter - LAN Port / 1000Mbps

Radiated Emissions	
Test Mode	Description
1	EUT + USB Port (up) + Adapter
2	EUT + USB Port (down) + Adapter
For Radiated Emission test below 1GHz: Mode 1 generated the worst test result, so it was recorded in this report. For Radiated Emission test above 1GHz: Mode 1 generated the worst test result for Radiated emission below 1GHz test, thus the measurement for Radiated emission above 1GHz test will follow this same test configuration.	

Harmonic Current Emissions · Voltage Fluctuations and Flicker · ESD · RS · EFT · Surge · CS · PFMF and DIP	
USB Port (up) has been evaluated to be the worst case at Radiated Emissions; thus, the measurement for EMS will follow this same test configuration.	
Test Mode	Description
1	EUT + USB Port (up) + Adapter

Note 1: The EUT can only be used in Z-axis position.

Note 2: The Adapter below is for measurement only, would not be marketed.

The Adapter information as below:

Support Unit	Brand	Model Number
Adapter	Seanen	KSA-24W-1200200VE



2.2. Description of Support Units

The EUT has been tested as an independent unit together with other necessary accessories or support units. The following support units or accessories were used to form a representative test configuration during the tests.

No.	Support Unit	Brand	Model	FCC ID
A	Flash disk3.0	Kingston	DTSE9 G2	N/A
B	Switch	Level One	GSW-0807	N/A
C	Server	PC Engines GmbH	apu2d2	N/A
D	LAN NB	DELL	E6430	N/A
E	Flash disk3.0	Transcend	JetFlash-700	N/A
F	Adapter	Seanen	KSA-24W-1200200VE	N/A

2.3. EUT Operation Condition

<EMI>

For Conducted Emissions Test and Radiated Emissions Test:

During the test, the following programs under WIN 7 were executed:

The remote notebook executed "Ping" to maintain the connection between the EUT and Server IP.

The remote notebook executed "Internet Explorer" to link with the EUT and Server to traffic packet data generated software.

The remote notebook executed "Internet Explorer", let USB read/write data from AP.

Disturbances at Telecommunication Ports

At the same time, the remote notebook executed "Nuwin" to link with the EUT to traffic packet data generated software and keep maximum traffic load by LAN.

<EMS>

During the test, the following programs under WIN 7 were executed:

The remote notebook executed "Ping" to maintain the connection between the EUT and Server IP.

The remote notebook executed "Internet Explorer" to link with the EUT and Server to traffic packet data generated software.

The remote notebook executed "Internet Explorer", let USB read/write data from AP.

2.4. Connection Diagram of Test System

2.4.1. AC Power Line Conduction Emissions Test Configuration

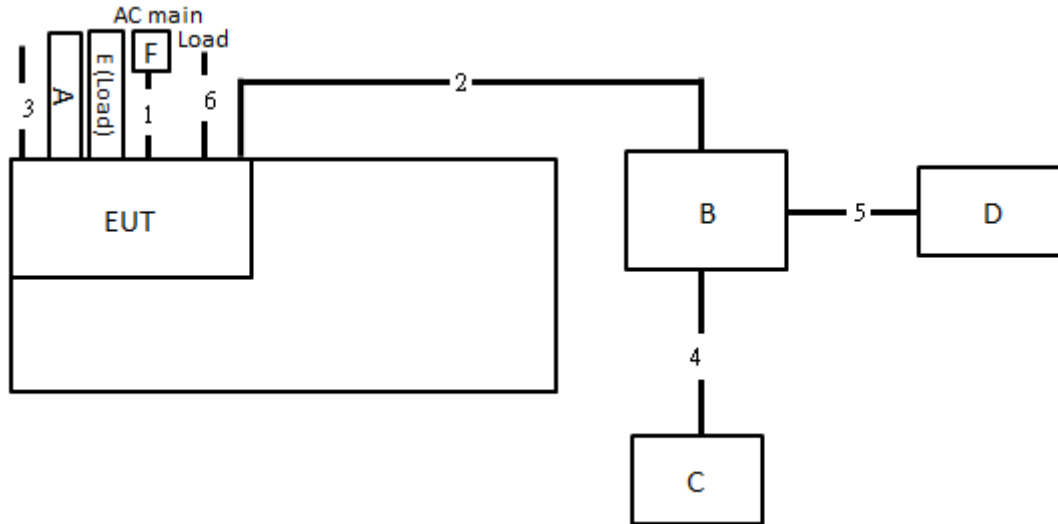

Item	Connection	Shielded	Length
1	Power cable	No	1.5m
2	RJ-45 cable	No	10m
3	RS232 cable	Yes	1.5m
4	RJ-45 cable	No	3m
5	RJ-45 cable	No	3m
6	RJ-45 cable*2	No	1.5m

2.4.2. Radiation Emissions Test Configuration

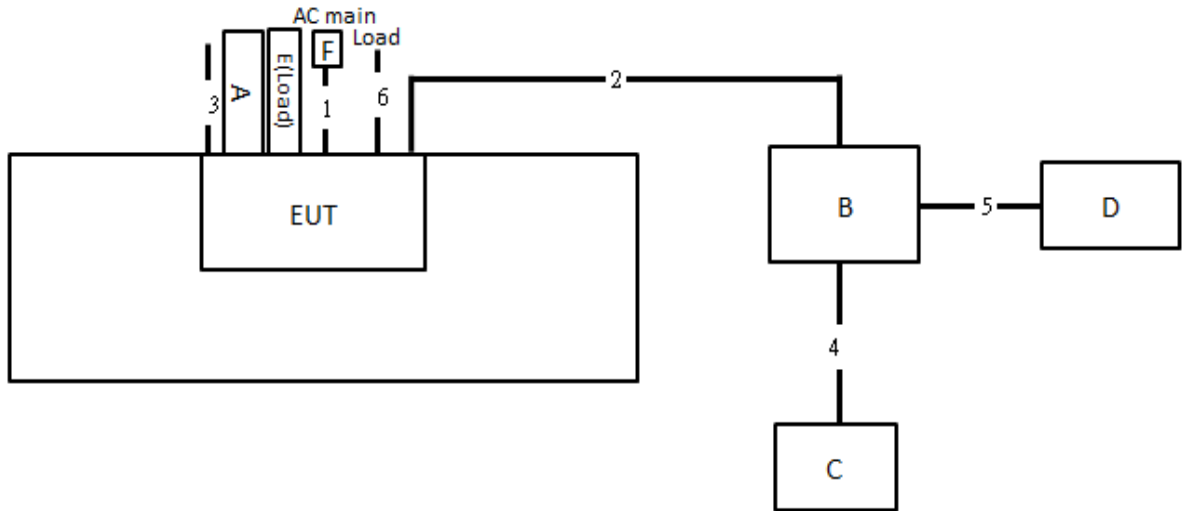

Item	Connection	Shielded	Length
1	Power cable	No	1.5m
2	RJ-45 cable	No	10m
3	RS232 cable	Yes	1.5m
4	RJ-45 cable	No	3m
5	RJ-45 cable	No	3m
6	RJ-45 cable*2	No	1.5m

3. General Information of Test

3.1. Test Facility

EMI	
JHU BEI	ADD : No.8, Lane 724, Bo-ai St., Jhubei City, HsinChu County 302, Taiwan, R.O.C. TEL : 886-3-656-9065 FAX : 886-3-656-9085
EMS	
JHU BEI	ADD : No.8, Lane 724, Bo-ai St., Jhubei City, HsinChu County 302, Taiwan, R.O.C. TEL : 886-3-656-9065 FAX : 886-3-656-9085

3.2. Test Environment

Test Items	Test Site No.	Test Engineer	Test Environment			Test Date	Remark
			Temp (°C)	Humidity (%)	Pressure (kPa)		
AC Power Port Conducted Emission	CO01-CB	Wei Li	24.3~24.5	55~56	-	May 03, 2019	-
Telecommunication Port Conducted Emission	CO01-CB	Wei Li	24.3~24.5	55~56	-	May 03, 2019	-
Radiated Emission below 1GHz	10CH01-CB	Ryo Fun	21.2~21.5	60~62	-	May 04, 2019	-
Radiated Emission above 1GHz	10CH01-CB	Ryo Fun	21.2~21.5	60~62	-	May 04, 2019	-
Harmonic Current Emission	EX02-CB	Rick Yeh	22.4~22.8	60.6~61.3	-	May 07, 2019	-
Voltage Fluctuations and Flicker	EX02-CB	Rick Yeh	22.4~22.8	60.6~61.3	-	May 07, 2019	-
ESD	ES02-CB	GN Hou	22.9~23.6	44~45	101.1~101.3	May 08, 2019	-
RS	RS01-CB	Peter Wu	21.4~22.0	60.3~61.0	-	May 07, 2019	-
EFT	EX02-CB	Rick Yeh	22.4~22.8	60.6~61.3	-	May 07, 2019	-
Surges	EX02-CB	GN Hou	21.8~22.4	67~69	-	May 08, 2019	-
CS	EX01-CB	Wei Li	23.4~24.4	55~60	-	May 03, 2019	-
PFMF	EX02-CB	Rick Yeh	22.4~22.8	60.6~61.3	-	May 07, 2019	-
Voltage dips and Interruptions	EX02-CB	Rick Yeh	22.4~22.8	60.6~61.3	-	May 07, 2019	-



3.3. Test Voltage

Power Type	Test Voltage
AC Power Supply	230 V / 50 Hz

3.4. Frequency Range Investigated

EMI Test Items	Frequency Range
Conducted emission test	150 kHz to 30 MHz
Radiated emission test	30 MHz to 6,000 MHz
EMS Test Items	Frequency Range
Radio frequency electromagnetic field immunity test	80 MHz to 1,000 MHz
Conducted immunity test	150 kHz to 80 MHz

3.5. Test Distance

Test Items	Test Distance
Radiated emission test below 1 GHz (30 MHz to 1,000 MHz)	10 m
Radiated emission test above 1 GHz (1,000 MHz to 6,000 MHz)	3 m
Radio frequency electromagnetic field immunity test	3 m

4. Test of Conducted Emission

4.1. Limit

4.1.1. Limit for AC power ports :

Frequency (MHz)	QP Limit (dBuV)	AV Limit (dBuV)
0.15~0.5	66~56	56~46
0.5~5	56	46
5~30	60	50

4.1.2. Limit for Telecommunication ports :

Frequency (MHz)	Voltage Limit (dBuV)		Current Limit (dBuA)	
	QP	AV	QP	AV
0.15~0.5	84~74	74~64	40~30	30~20
0.5~30	74	64	30	20

4.2. Description of Major Test Instruments

Test Receiver	Setting
Start Frequency	0.15 MHz
Stop Frequency	30 MHz
IF Bandwidth	9 kHz

4.3. Test Procedures

- a. The EUT was placed on a desk 0.8 meters height from the metal ground plane and 0.4 meter from the conducting wall of the shielding room and it was kept at least 0.8 meters from any other grounded conducting surface.
- b. Connect EUT to the power mains through a line impedance stabilization network (LISN).
- c. Connect Telecommunication port to ISN (Impedance Stabilization Network).
- d. All the support units are connect to the other LISN.
- e. The LISN provides 50 Ω coupling impedance for the measuring instrument.
- f. The CISPR states that a 50 Ω , 50 μ H LISN should be used.
- g. Both sides of AC line were checked for maximum conducted interference.
- h. The frequency range from 150 kHz to 30 MHz was searched.
- i. Set the test-receiver system to Peak Detect Function and Specified Bandwidth with Maximum Hold Mode.

4.4. Measurement Results Calculation

The measured Level is calculated using:

For AC Power Port Conducted Emission

- a. Corrected Reading (dBuV) = LISN Factor + Cable Loss + Read Level = Level
- b. Margin = - Limit + (Read Level + LISN Factor + Cable Loss)

For Telecommunication Port Conducted Emission

- a. Corrected Reading (dBuV) = LISN Factor + Cable Loss + Read Level = Level
- b. Margin = - Limit + (Read Level + LISN Factor + Cable Loss)

4.5. Typical Test Setup Layout of Conducted Emission and disturbances at telecommunication ports

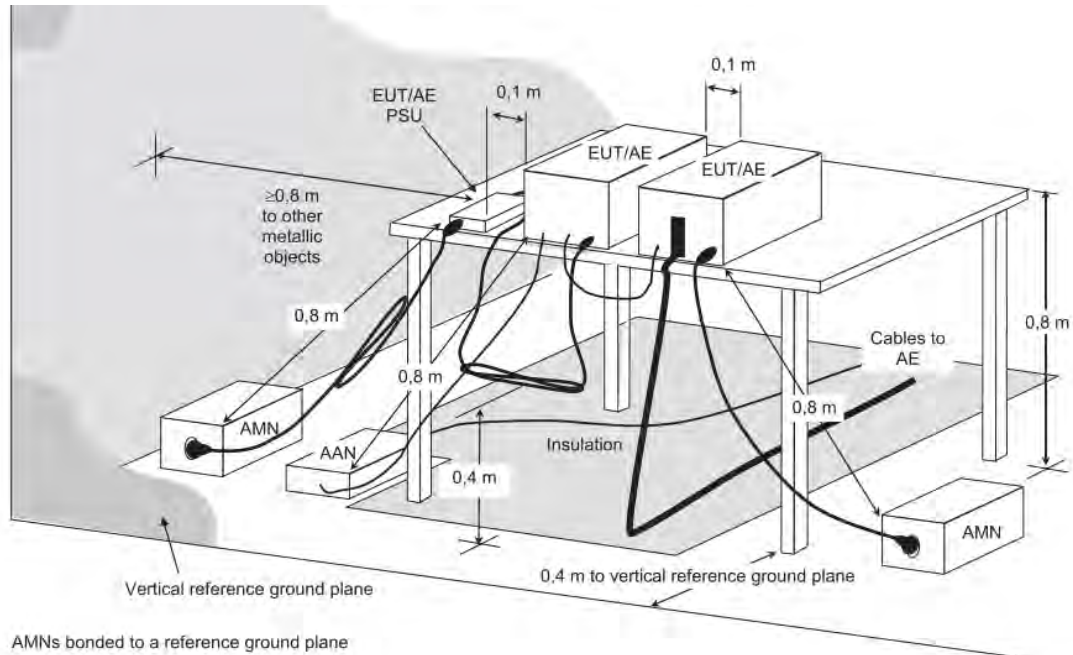



4.6. Test Result of AC Power Ports

Refer as Appendix A

4.7. Test Result of Telecommunication Ports

Refer as Appendix B



5. Test of Radiated Emission

5.1. Limit

Radiated Emission below 1 GHz test at 10 m:

Frequency (MHz)	QP (dBuV/m)
30~230	30
230~1,000	37

Radiated Emission above 1 GHz test at 3 m:

Frequency (MHz)	PK (dBuV/m)	AV (dBuV/m)
1,000~3,000	70	50
3,000~6,000	74	54

5.2. Description of Major Test Instruments

5.2.1. 30 MHz ~ 1,000 MHz

Amplifier	Setting
RF Gain	25 dB
Signal Input	9 kHz to 1.3 GHz

Spectrum Analyzer	Setting
Start Frequency	30 MHz
Stop Frequency	1000 MHz
Resolution Bandwidth	120 kHz
Signal Input	9 kHz to 30 GHz

Test Receiver	Setting
Start Frequency	30 MHz
Stop Frequency	1000 MHz
Resolution Bandwidth	120 kHz
Signal Input	9 kHz to 3 GHz

5.2.2. Above 1 GHz

Amplifier	Setting
RF Gain	35 dB
Signal Input	1 GHz to 26.5 GHz

Spectrum Analyzer	Setting
Start Frequency	1 GHz
Stop Frequency	6 GHz
Resolution Bandwidth	1 MHz
Signal Input	9 kHz to 30 GHz



5.3. Test Procedures

<Below 1 GHz>:

- a. The EUT was placed on a rotatable table top 0.8 meter above ground.
- b. The EUT was set 10 meters from the interference receiving antenna which was mounted on the top of a variable height antenna tower.
- c. The table was rotated 360 degrees to determine the position of the highest radiation.
- d. The antenna is a half wave dipole and its height is varied between one meter and four meters above ground to find the maximum value of the field strength both horizontal polarization and vertical polarization of the antenna are set to make the measurement.
- e. For each suspected emission the EUT was arranged to its worst case and then tune the antenna tower (from 1 M to 4 M) and turn table (from 0 degree to 360 degrees) to find the maximum reading.
- f. Set the test-receiver system to Peak Detect Function and specified bandwidth with Maximum Hold Mode.
- g. If the emission level of the EUT in peak mode was 3 dB lower than the limit specified, then testing will be stopped and peak values of EUT will be reported, otherwise, the emissions which do not have 3 dB margin will be repeated one by one using the quasi-peak method and reported.



<Above 1 GHz>:

- a. Same test set up as below 1 GHz radiated testing.
- b. The EUT was set 3 meters from the interference-receiving antenna which was mounted on the top of a variable height antenna tower.
- c. There should be absorber placed between the EUT and Antenna and its located size should let the test site meet CISPR16-1-4 requirement.
- d. The table was rotated 360 degrees to determine the position of the highest radiation.
- e. Set the test-receiver system to Peak Detect Function and specified bandwidth with Maximum Hold Mode.
- f. Set the DRG Horn Antenna at 1M height, then run the turn table to get the maximum noise reading from Horizontal and Vertical polarity separately.
- g. When EUT locating on the turn-table, and its height is over 172 cm (Antenna's 3dB beam width of 6 GHz is 27°), the DRG Horn Antenna must be raised up and descended down, then turning around the turn-table to get the maximum noise reading of the Horizontal and Vertical polarity separately. Note the maximum raise up height is same as the top of EUT.
- h. If emission level of the EUT in peak mode was 20 dB lower than average limit (that means the emission level in peak mode also complies with the limit in average mode), then testing will be stopped and peak values of EUT will be reported, otherwise, the emissions will be measured in average mode again and reported.

5.4. Measurement Results Calculation

The measured Level is calculated using:

- a. Corrected Reading: Antenna Factor + Cable Loss + Read Level - Preamp Factor = Level
- b. Margin = - Limit + (Read Level + Antenna Factor + Cable Loss - Preamp Factor)

5.5. Typical Test Setup Layout of Radiated Emission

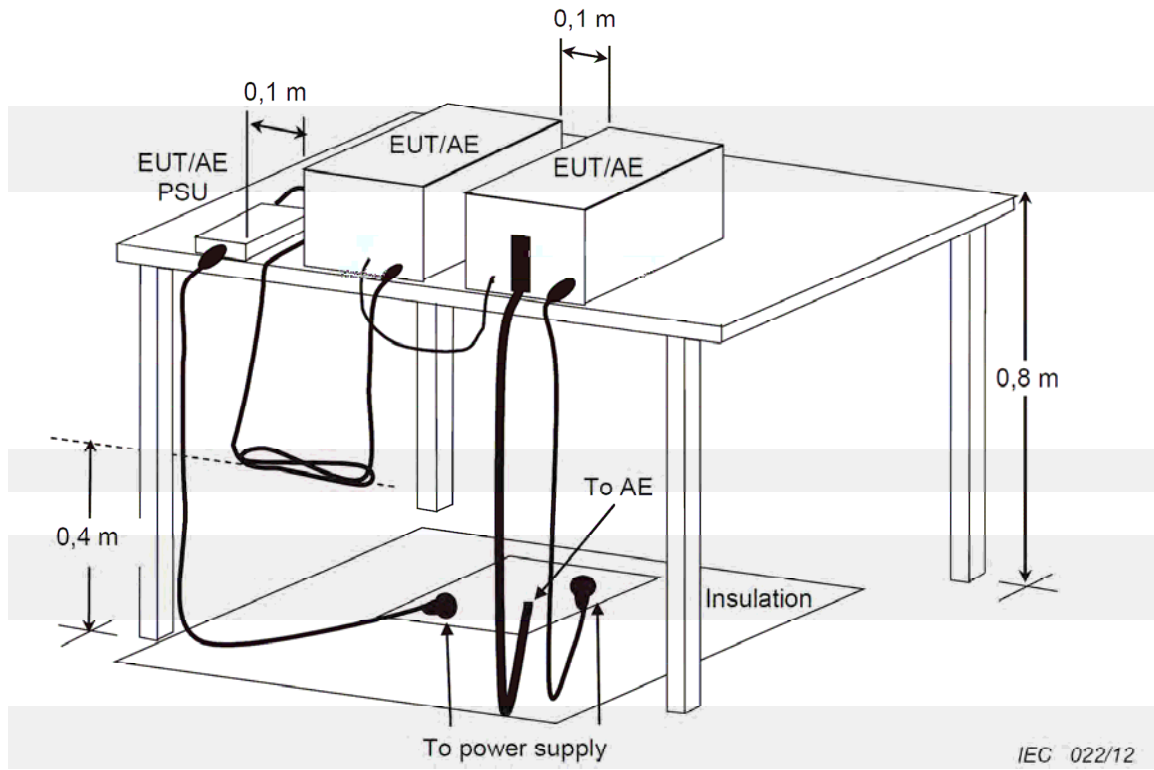

<Below 1 GHz>:

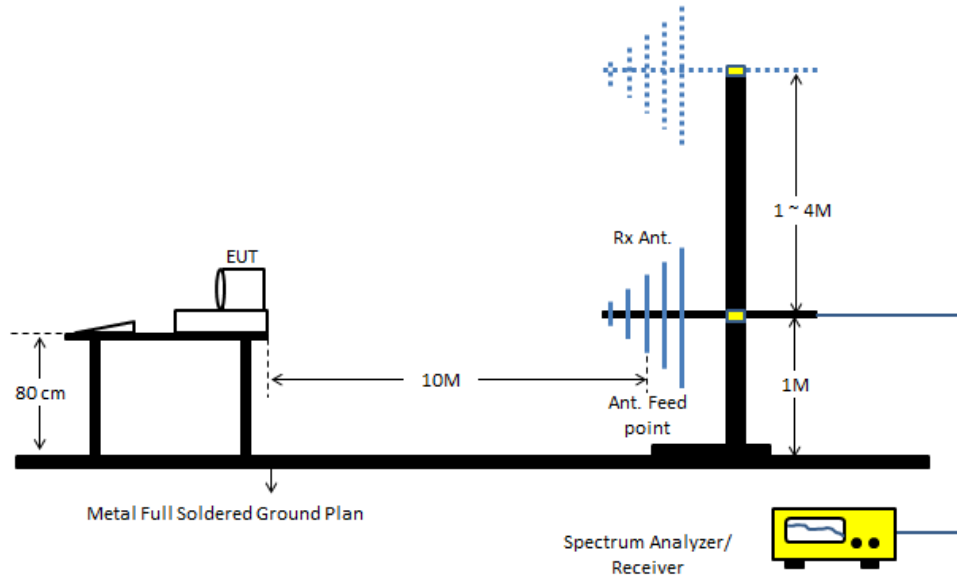

<Above 1 GHz>:

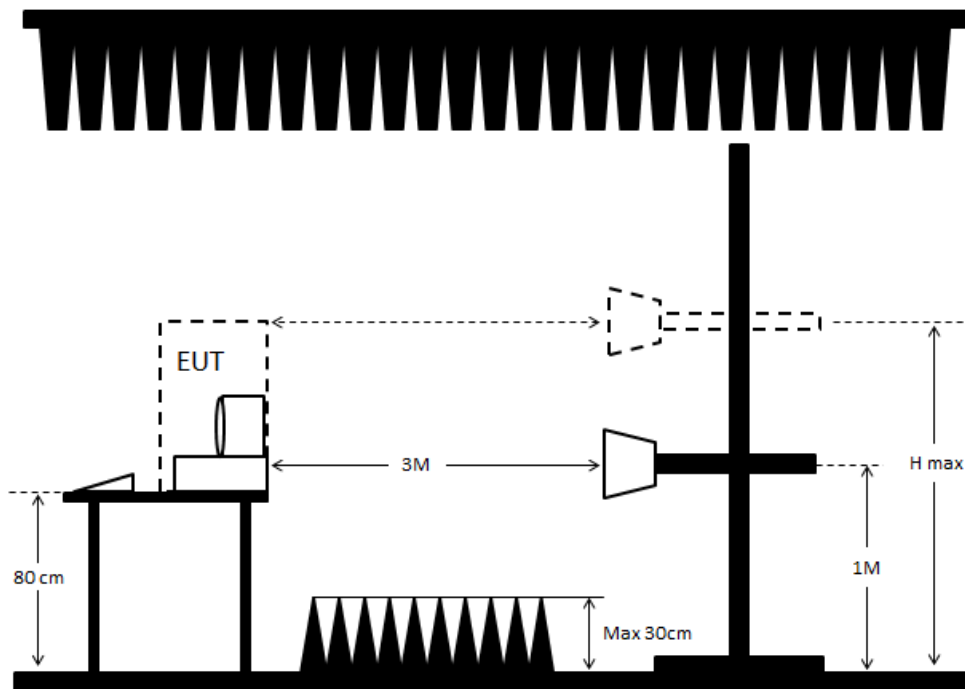

Remark : When EUT height is over 172cm , H max = Top of EUT



5.6. Test Result of Radiated Emission below 1 GHz

Refer as Appendix C

5.7. Test Result of Radiated Emission above 1 GHz

Refer as Appendix C

6. Harmonics Test

6.1. Standard

- EN 61000-3-2:2014

6.2. Test Procedure

The measured values of the harmonics components of the input current, including line current and neutral current, shall be compared with the limits given in Clause 7 of EN 61000-3-2.

6.3. Test Equipment Settings

Line Voltage	230 V
Line Frequency	50 Hz
Device Class	A

6.4. Test Setup

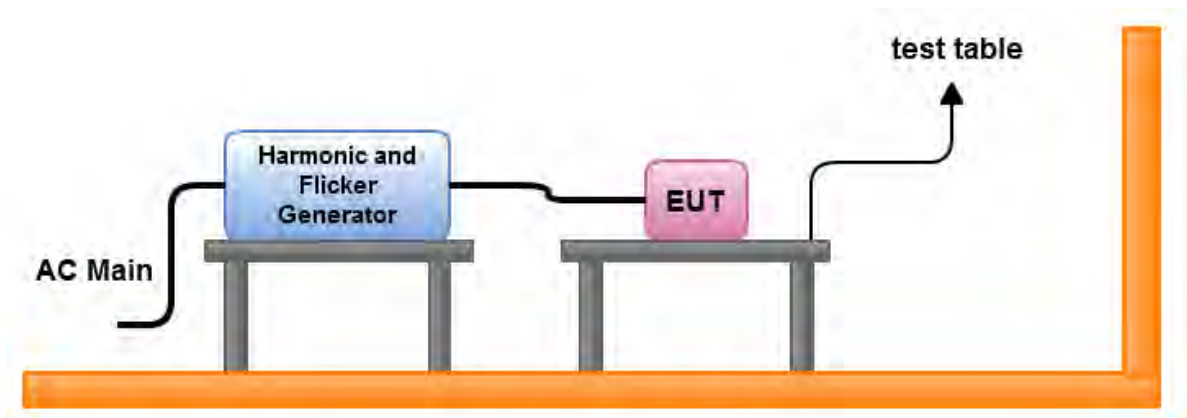

6.5. Test Result of Current Harmonics Test

Refer as Appendix D

7. Voltage Fluctuations and Flicker Test

7.1. Standard

- EN 61000-3-3:2013

7.2. Test Procedure

The equipment shall be tested under the conditions of **Clause 5**.

The total impedance of the test circuit, excluding the appliance under test, but including the internal impedance of the supply source, shall be equal to the reference impedance. The stability and tolerance of the reference impedance shall be adequate to ensure that the overall accuracy of $\pm 8\%$ is achieved during the whole assessment procedure.

7.3. Test Equipment Settings

Line Voltage	230 V
Line Frequency	50 Hz

7.4. Test Setup

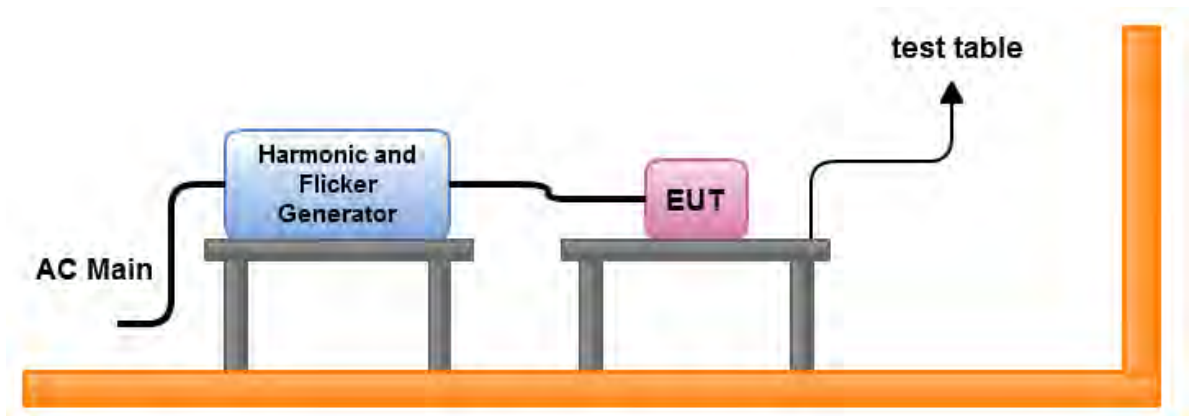

7.5. Test Result of Voltage Fluctuation and Flicker Test

Refer as Appendix E

8. General Performance Criteria Description of Immunity Test

According to Clause 7.1 of EN 55024 standard, the following describes the general performance criteria.

<p>Criterion A (Note 1)</p>	<p>During and after the test the EUT shall continue to operate as intended without operator intervention. No degradation of performance or loss of function is allowed below a minimum performance level specified by the manufacturer when the EUT is used as intended.</p>
<p>Criterion B (Note 2)</p>	<p>During the test, degradation of performance is allowed. However, no change of operating state or stored data is allowed to persist after the test. After the test, the equipment shall continue to operate as intended without operator intervention. For xDSL Terminal equipment: During the test shall not cause the system to lose the established connection or retrain. At the cessation of the test, the system shall operate in the condition established prior to the application of the test without user intervention.</p>
<p>Criterion C</p>	<p>Loss of function is allowed, provided the function is self-recoverable, or can be restored by the operation of the controls by the user in accordance with the manufacturer's instructions. Functions, and/or information stored in non-volatile memory, or protected by a battery backup, shall not be lost.</p>
<p>Note 1 : No degradation of performance or loss of function is allowed below a performance level specified by the manufacturer when the equipment is used as intended. The performance level may be replaced by a permissible loss of performance. If the minimum performance level or the permissible performance loss is not specified by the manufacturer, then either of these may be derived from the product description and documentation, and by what the user may reasonably expect from the equipment if used as intended.</p> <p>Note 2 : After the application of the phenomenon below a performance level specified by the manufacturer, when the equipment is used as intended. The performance level may be replaced by a permissible loss of performance. During the test, degradation of performance is allowed. However, no change of operating state if stored data is allowed to persist after the test. If the minimum performance level (or the permissible performance loss) is not specified by the manufacturer, then either of these may be derived from the product description and documentation, and by what the user may reasonably expect from the equipment if used as intended.</p>	



9. EUT Performance Criteria

Test Type	Pass Criterion
Electrostatic discharge immunity test ± 2, 4 kV Contact Discharge ± 2, 4, 8 kV Air Discharge Standard Criterion B	B
Radiated immunity test Frequency Range : 80 MHz to 1,000 MHz Electromagnetic field : 3 V/m (unmodulated, r.m.s) Amplitude modulated : 80 % AM (1 kHz) Standard Criterion A	A
Electrical fast transient / burst immunity test AC ports 5/50 ns, ± 1 kV, 5 kHz I/O ports 5/50 ns, ± 0.5 kV, 5 kHz Standard Criterion B	A
Surge immunity test AC ports (1.2/50 us) : line to line : ± 0.5, 1 kV Standard Criterion B	A
Conducted Immunity test Frequency Range : 150 kHz to 80 MHz Electromagnetic field : 3 V (unmodulated, r.m.s) Amplitude modulated : 80 % AM (1 kHz) Standard Criterion A	A
Power frequency magnetic field immunity test 1 A/m, 50 Hz Standard Criterion A	A
Voltage dips, short interruptions and voltage variations immunity tests 1. >95% reduction 10 ms (0.5 cycles) – Standard Criterion B	A
2. 30% reduction 500 ms (25 cycles) – Standard Criterion C	A
3. Interruption >95% reduction 5,000 ms (250 cycles) – Standard Criterion C	C

10. Electrostatic Discharge Immunity Test (ESD)

10.1. Test Specification

Reference Standard	IEC 61000-4-2
Discharge Impedance	330 ohm / 150 pF
Contact Discharge	$\pm 2, 4$ kV
Air Discharge	$\pm 2, 4, 8$ kV
Rise Time	0.8 ns +/-25 %
Current at 30 ns	+/- 30 %
Current at 60 ns	+/- 30 %
Polarity	Positive / Negative
Number of Discharge	Air Discharge 20 times at each test point
	Contact Discharge 50 times at each test point
Single Discharge Mode	1 discharge per 1s

10.2. Test Setup

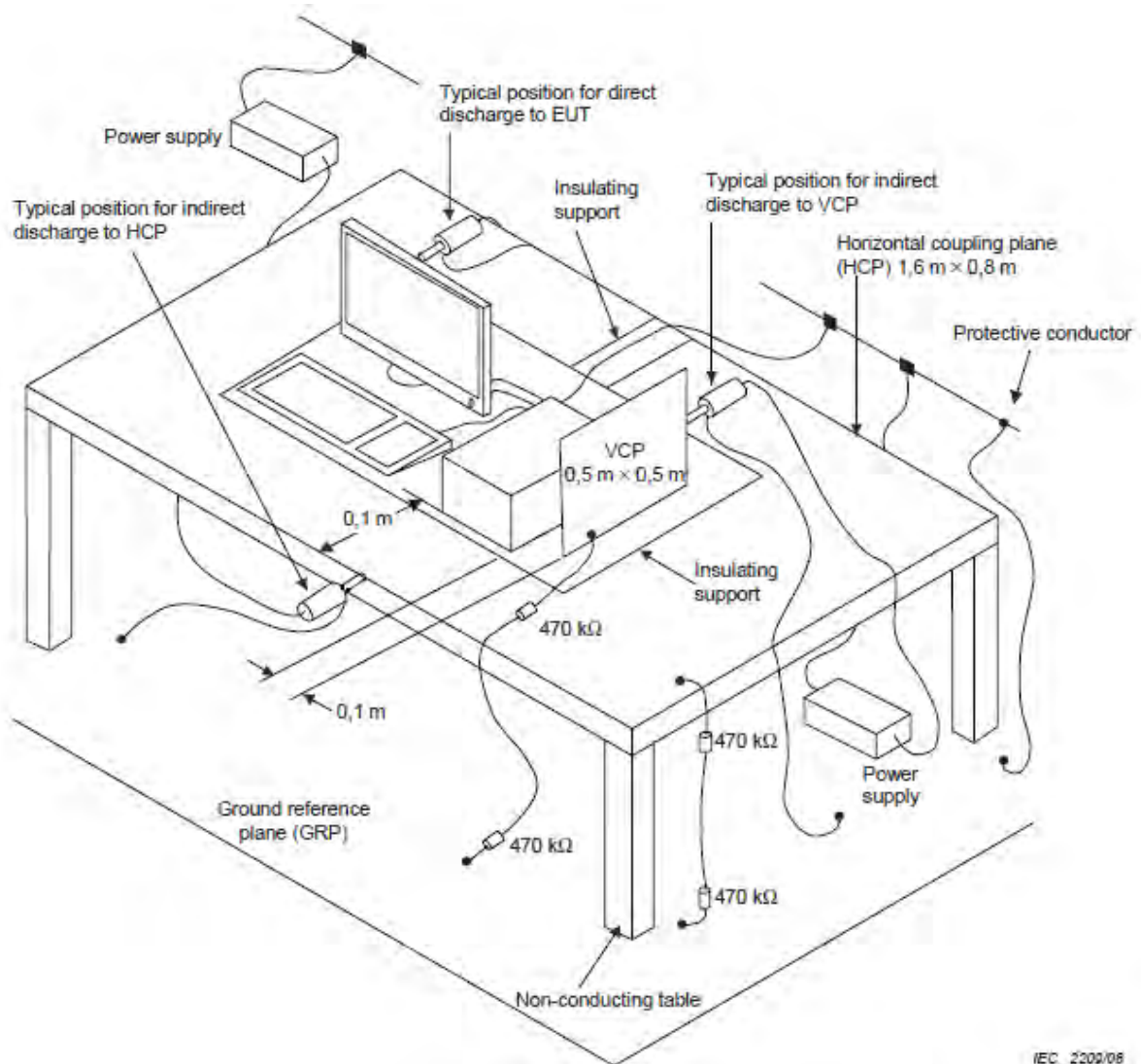

The test setup consists of the test generator, EUT and auxiliary instrumentation necessary to perform DIRECT and INDIRECT application of discharges to the EUT as applicable, in the follow manner:
 CONTACT DISCHARGE to the conductive surfaces and to coupling plane;
 AIR DISCHARGE at insulating surfaces.

The preferred test method is that of type tests performed in laboratories and the only accepted method of demonstrating conformance with this standard. The EUT was arranged as closely as possible to arrangement in final installed conditions.



10.3. Test Setup for Tests Performed in Laboratory

A ground reference plane was provided on the floor of the test site. It was a metallic sheet (copper or aluminum) of 0.25 mm, minimum thickness; other metallic may be used but they shall have at least 0.65 mm thickness. In the SPORTON EMC LAB., we provided 1 mm thickness aluminum ground reference plane or 1 mm thickness stainless steel ground reference plane. The minimum size of the ground reference plane is 1 m x 1 m, the exact size depending on the dimensions of the EUT. It was connected to the protective grounding system.

The EUT was arranged and connected according to its functional requirements. A distance of 1m minimum was provided between the EUT and the wall of the lab. and any other metallic structure. In cases where this length exceeds the length necessary to apply the discharges to the selected points, the excess length shall, where possible, be placed non-inductively off the ground reference plane and shall not come closer than 0.2m to other conductive parts in the test setup.

Where the EUT is installed on a metal table, the table was connected to the reference plane via a cable with a 470k ohm resistor located at each end, to prevent a build-up of charge. The test setup was consist a wooden table, 0.8m high, standing on the ground reference plane. A HCP, 1.6 m x 0.8 m, was placed on the table. The EUT and cables was isolated from the HCP by an insulating support 0.5 mm thick. The VCP size, 0.5 m x 0.5 m.

10.4. ESD Test Procedure

- a. In the case of air discharge testing the climatic conditions shall be within the following ranges:
 - ambient temperature: 15°C to 35°C;
 - relative humidity : 30% to 60%;
 - atmospheric pressure : 86 kPa (860 mbar) to 106 kPa (1060 mbar).
- b. Test programs and software shall be chosen so as to exercise all normal modes of operation of the EUT.

The use of special exercising software is encouraged, but permitted only where it can be shown that the EUT is being comprehensively exercised.
- c. The test voltage shall be increased from the minimum to the selected test severity level, in order to determine any threshold of failure. The final severity level should not exceed the product specification value in order to avoid damage to the equipment.
- d. For the time interval between successive single discharges an initial value of one second is recommended. Longer intervals may be necessary to determine whether a system failure has occurred.
- e. In the case of contact discharges, the tip of the discharge electrode shall touch the EUT before the discharge switch is operated.
- f. In the case of painted surface covering a conducting substrate, the following procedure shall be adopted:
 - If the coating is not declared to be an insulating coating by the equipment manufacturer, then the pointed tip of the generator shall penetrate the coating so as to make contact with the conducting substrate.
 - Coating declared as insulating by the manufacturer shall only be submitted to the air discharge.
 - The contact discharge test shall not be applied to such surfaces.
- g. In the case of air discharges, the round discharge tip of the discharge electrode shall be approached as fast as possible (without causing mechanical damage) to touch the EUT . After each discharge, the ESD generator (discharge electrode) shall be removed from the EUT. The generator is then retriggered for a new single discharge. This procedure shall be repeated until the discharges are completed. In the case of an air discharge test, the discharge switch, which is used for contact discharge, shall be closed.



10.5. Test Result

Refer as Appendix F

11. Radio Frequency Electromagnetic Field Immunity Test (RS)

11.1. Test Specification

Reference Standard	IEC 61000-4-3
Frequency Range	80 MHz to 1,000 MHz
Field Strength	3 V/m (un-modulated, r.m.s) 80% AM (1 kHz)
Frequency Step	1 %
Dwell Time	2.9 sec
Antenna Polarity	Vertical / Horizontal

11.2. Test Setup

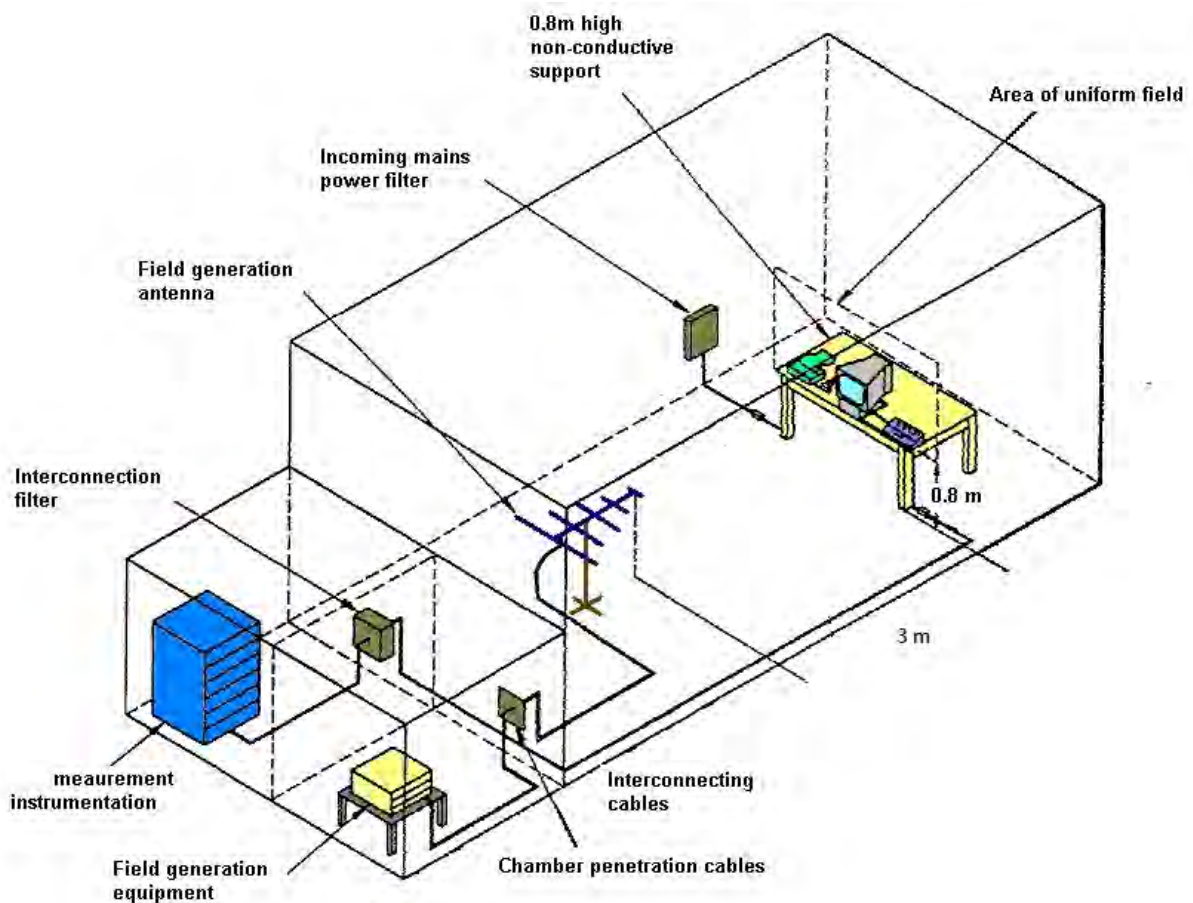

The procedure defined in this part requires the generation of electromagnetic fields within which the test sample is placed and its operation observed. To generate fields that are useful for simulation of actual (field) conditions may require significant antenna drive power and the resultant high field strength levels.



11.3. Test Procedure

- a. The equipment to be tested is placed in the center of the enclosure on a wooden table. The equipment is then connected to power and signal leads according to pertinent installation instructions.
- b. The bilog antenna which is enabling the complete frequency range of 80-1,000 MHz is placed 3m away from the equipment. The required field strength is determined by placing the field strength meter(s) on top of or directly alongside the equipment under test and monitoring the field strength meter via a remote field strength indicator outside the enclosure while adjusting the continuous-wave to the applicable antennae.
- c. The test is normally performed with the generating antenna facing each of four sides of the EUT. The polarization of the field generated by the broadband (bilog) antenna necessitates testing each position twice, once with the antenna positioned vertically and again with the antenna positioned horizontally.
- d. At each of the above conditions, the frequency range is swept 80-1,000 MHz, pausing to adjust the R.F. signal level or to switch oscillators and antenna. The rate of sweep is in the order of 1.5×10^{-3} decades/s. The sensitive frequencies or frequencies of dominant interest may be discretely analyzed.

11.4. Test Result

Refer as Appendix F



12. Electrical Fast Transient/Burst Immunity Test (EFT/BURST)

12.1. Test Specification

Reference Standard	IEC 61000-4-4
Test Voltage	AC Power Line: ± 1 kV
	Telecommunication/Signal Line: ± 0.5 kV
Polarity	Positive / Negative
Rise time of the pulses	5 ns
Impulse duration	50 ns
Burst duration	15 ms for 5 kHz
Burst period	300 ms
Impulse Frequency	Power: 5 kHz
	Telecommunication/Signal: 5 kHz
Duration	1 min

12.2. Test Setup

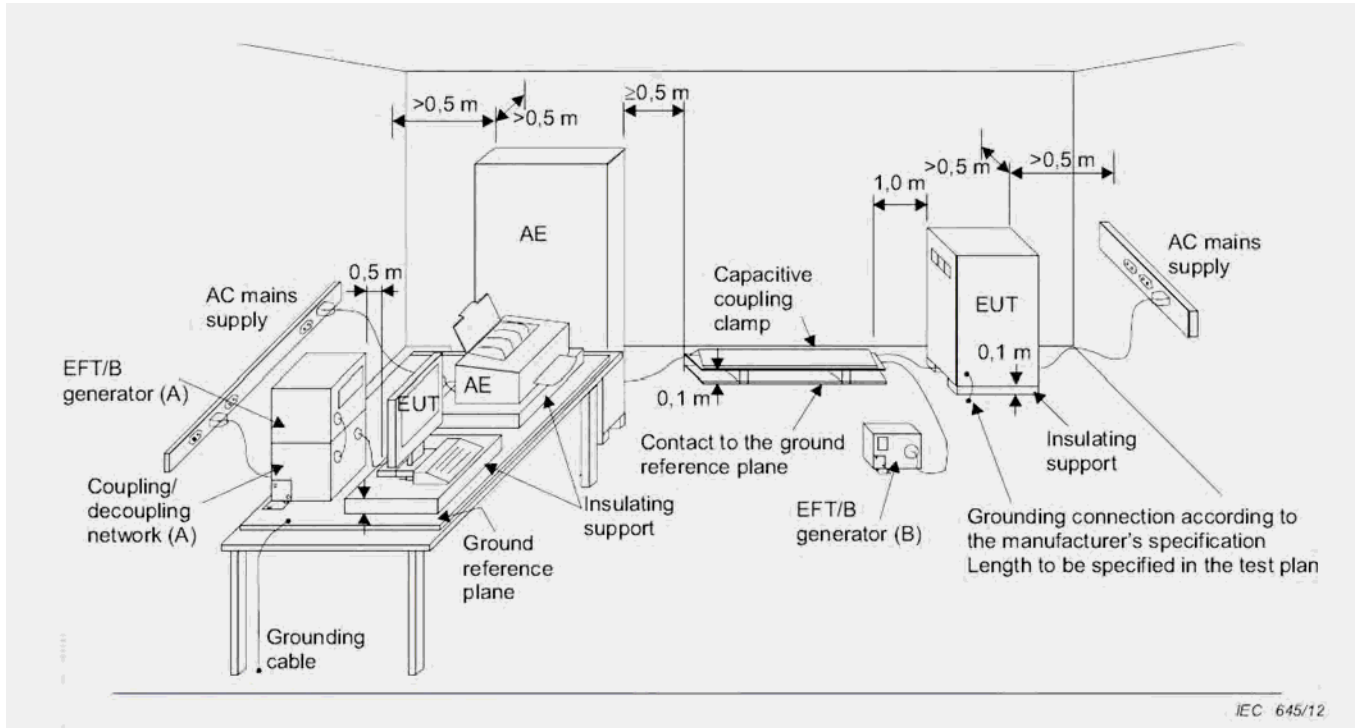

The EUT was placed on a ground reference plane and was insulated from it by an insulating support about 0.1m thick. If the EUT is table-top equipment, it was located approximately 0.8 m above the GRP. The GRP. Was a metallic sheet (copper or aluminum) of 0.25 mm ,minimum thickness; other metallic may be used but they shall have at least 0.65 mm thickness. It shall project beyond the EUT by at least 0.1 m on all sides and connected to the protective earth. In the SPORTON EMC LAB. We provided 1 mm thickness aluminum ground reference plane or 1 mm thickness stainless steel ground reference plane. The minimum size of the ground reference plane is 1 m x 1 m, the exact size depending on the dimensions of the EUT. It was connected to the protective grounding system. The EUT was arranged and connected according to its functional requirements. The minimum distance between the EUT and other conductive structures, except the GRP. Beneath the EUT, was more than 0.5 m. Using the coupling clamp, the minimum distance between the coupling plates and all other conductive structures, except the GRP. Beneath the EUT, was more than 0.5 m. The length of the signal and power lines between the coupling device and the EUT was 0.5m or less.



12.3. Test Procedure

- a. In order to minimize the effect of environmental parameters on test results, the climatic conditions when test is carrying out shall comply with the following requirements:
 - ambient temperature: 15°C to 35°C;
 - relative humidity : 45% to 75%;
 - atmospheric pressure : 86 kPa (860 mbar) to 106 kPa (1060 mbar).
- b. In order to minimize the effect of environmental parameters on test results, the electromagnetic environment of the laboratory shall not influence the test results.
- c. The variety and diversity of equipment and systems to be tested make it difficult to establish general criteria for the evaluation of the effects of fast transients/bursts on equipment and systems.
- d. The test results may be classified on the basic of the operating conditions and the functional specification of the equipment under test, according to the following performance criteria :
 - Normal performance within the specification limits.
 - Temporary degradation or loss of function or performance which is self-recoverable.
 - Temporary degradation or loss of function or performance which requires operator intervention or system reset.
 - Degradation or loss of function which is not recoverable due to damage of equipment (components).

12.4. Test Result

Refer as Appendix F

13. Surge Immunity Test

13.1. Test Specification

Reference Standard	IEC 61000-4-5
Test Voltage	AC Power Port: line to line : $\pm 0.5, 1$ kV
Polarity	Positive / Negative
Wave Shape	Power Port: 1.2/50 us Open-circuit voltage 8/20 us Short-circuit current
Phase Angle	0° , 90° , 180° , 270°
Time between successive pulses	60 sec.
Number of test	5 positive and 5 negative

13.2. Test Setup



13.3. Test Procedure

a. Climatic conditions

The climatic conditions shall comply with the following requirements :

- ambient temperature : 15 °C to 35 °C
- relative humidity : 10 % to 75 %
- atmospheric pressure : 86 kPa to 106 kPa (860 mbar to 1060 mbar)

b. Electromagnetic conditions

The electromagnetic environment of the laboratory shall not influence the test results.

c. The test shall be performed according the test plan that shall specify the test set-up with

- generator and other equipment utilized;
- test level (voltage/current);
- generator source impedance;
- internal or external generator trigger;
- number of tests: at least five positive and five negative at the selected points;
- repetition rate: maximum 1/min.
- inputs and outputs to be tested;
- representative operating conditions of the EUT;
- sequence of application of the surge to the circuit;
- phase angle in the case of a.c. power supply;
- actual installation conditions, for example :
 - AC : neutral earthed,
 - DC : (+) or (-) earthed to simulated the actual earthing conditions.

d. If not otherwise specified the surges have to be applied synchronized to the voltage phase at the zero-crossing and the peak value of the a.c. voltage wave (positive and negative).

e. The surges have to be applied line to line and line(s) and earth. When testing line to earth, the test voltage has to be applied successively between each of the lines and earth, if there is no other specification.

f. The test procedure shall also consider the non-linear current-voltage characteristics of the equipment under test. Therefore the test voltage has to be increased by steps up to the test level specified in the product standard or test plan.

g. If the actual operating signal sources are not available, they may be simulated. Under no circumstances may the test level exceed the product specification. The test shall be carried out according to the test plan.

h. To find all critical points of the duty cycle of the equipment, a sufficient number of positive and negative test pulses shall be applied. For acceptance test a previously unstressed equipment shall be used to the protection devices shall be replaced.



13.4. Test Result

Refer as Appendix F

14. Conducted Disturbances Induced by Radio-Frequency Field Immunity Test (CS)

14.1. Test Specification

Reference Standard	IEC 61000-4-6
Frequency Range	150 kHz~80 MHz
Field Strength	3 Vr.m.s (un-modulated, r.m.s) 80% AM (1 kHz)
Frequency Step	1 %
Dwell Time	2.9 sec
Coupling mode	M016(M3), CDN T8-10

14.2. Test Setup

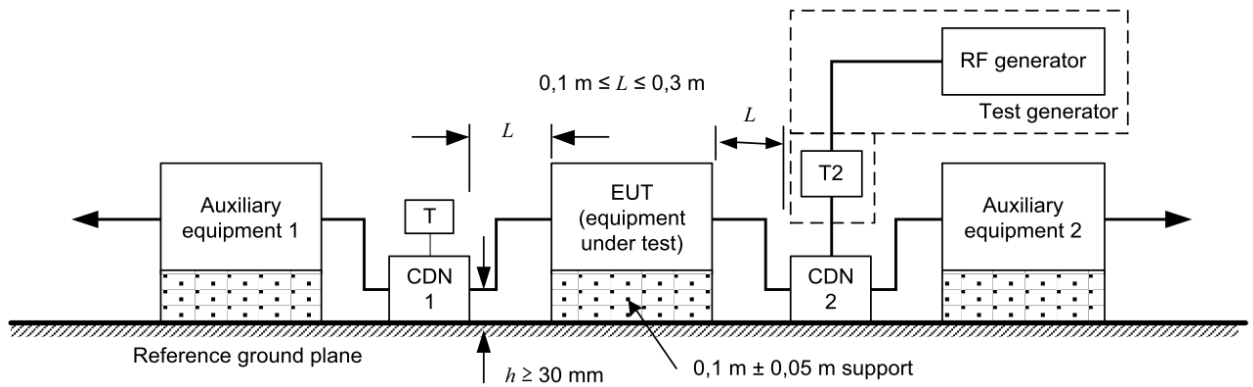

14.3. Test Procedure

- a. The EUT shall be operated within its intended climatic conditions. The temperature and relative humidity should be recorded.
- b. This test method test can be performed without using a self-shielded enclosure. This is because the disturbance levels applied and the geometry of the setups are not likely to radiated a high amount of energy, especially at the lower frequencies. If under certain circumstances the radiated energy is too high, a shielded enclosure has to be used.
- c. The test shall be performed with the test generator connected to each of the coupling and decoupling devices in turn while the other non-excited RF-input ports of the coupling devices are terminated by a 50 ohm load resistor.
- d. The frequency range is swept from 150 kHz to 80 MHz, using the signal levels established during the setting process, and with the disturbance signal 80% amplitude modulated with a 1kHz sinewave, pausing to adjust the RF-signal level or to switch coupling devices as necessary. The rate of sweep shall no exceed 1.5×10^{-3} decades/s. Where the frequency is swept incrementally, the step size shall no exceed 1% of the start and thereafter 1% of the preceding frequency value.
- e. The dwell time at each frequency shall not be less than the time necessary for the EUT to be exercised, and able to respond. Sensitive frequencies e.g. clock frequency(ies) and harmonics or frequencies of dominant interest shall be analyzed separately.
- f. In cases of dispute, the test procedure using a step size not exceeding 1% of the start and thereafter 1% of preceding frequency value shall take precedence.
- g. Attempts should be made to fully exercise the EUT during testing, and to fully interrogate all exercise modes selected for susceptibility.
- h. The use of special exercising programs is recommended.
- i. Testing shall be performed according to a Test Plan, which shall be included in the test report.
- j. It may be necessary to carry out some investigatory testing in order to establish some aspects of the test plan.

14.4. Test Result

Refer as Appendix F

15. Power Frequency Magnetic Field Immunity Tests

15.1. Test Specification

Reference Standard	IEC 61000-4-8
Power Frequency	50 Hz
Field Strength	1 A/m
Observation type	1 min
Inductance Coil	1 m x 1 m

15.2. Test Setup

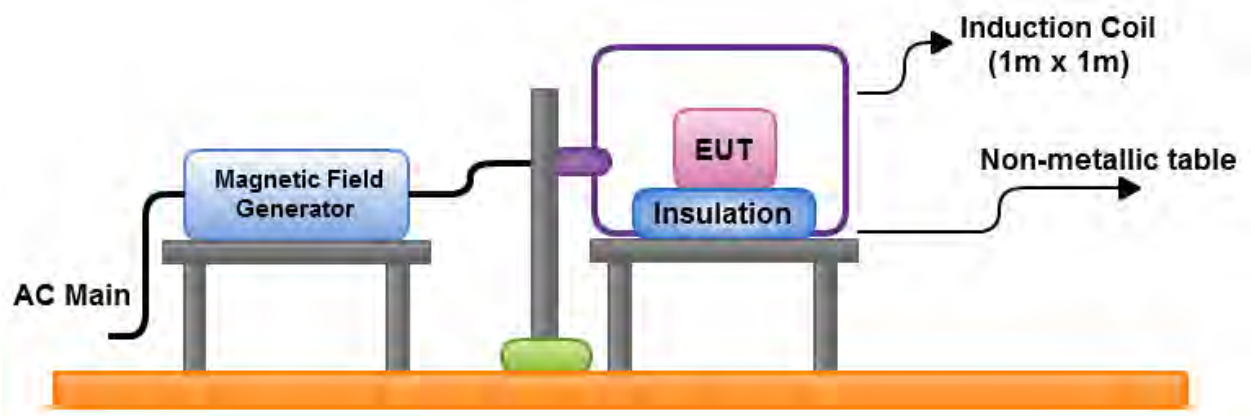

15.3. Test Procedure

- The equipment is configured and connected to satisfy its functional requirements.
- The power supply, input and output circuits shall be connected to the sources of power supply, control and signal.
- The cables supplied or recommended by the equipment manufacturer shall be used. 1 meter of all cables used shall be exposed to the magnetic field.

15.4. Test Result

Refer as Appendix F

16. Voltage Dips and Voltage Interruptions Immunity Tests

16.1. Test Specification

Reference Standard	IEC 61000-4-11
Test Voltage	Voltage Dip :
	1. >95%, Reduction, 0.5 period
	2. 30%, Reduction, 25 period
	Voltage interruptions
	3. >95%, Reduction, 250 period
Test Duration Time	3 times
Intervals between event	10 sec.
Test Angle	0, 180°

16.2. Test Setup

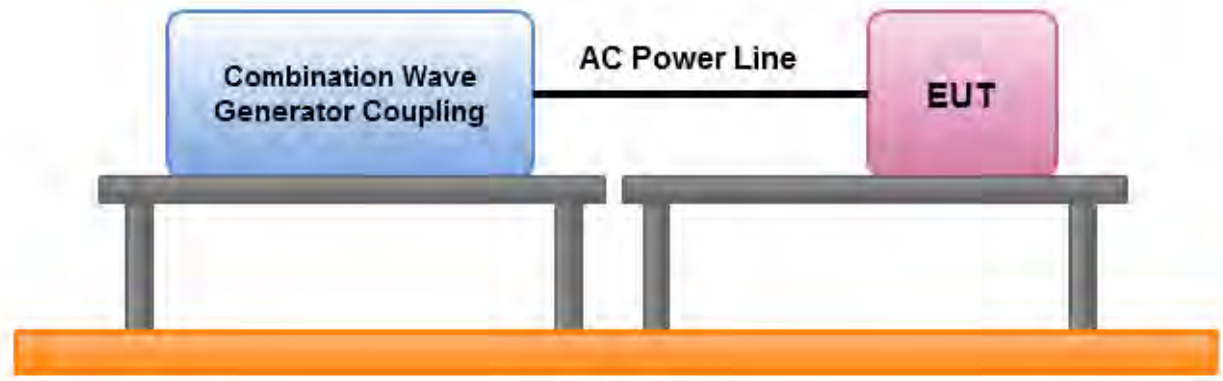

16.3. Test Conditions

1. Source voltage and frequency: 100/230/240V / 50Hz, Single phase.
2. Test of interval: 10 sec.
3. Level and duration: Sequency of 3 dips/interrupts.
4. Voltage rise (and fall) time: 1 ~ 5 μ s.

16.4. Test Result

Refer as Appendix F



17. List of Measuring Equipment Used

<EMI>

Instrument	Manufacturer	Model No.	Serial No.	Characteristics	Calibration Date	Calibration Due Date	Remark
EMI Receiver	Agilent	N9038A	My52260123	9kHz ~ 8.45GHz	Jan. 28, 2019	Jan. 29, 2020	Conduction (CO01-CB)
LISN	F.C.C.	FCC-LISN-50-1 6-2	04083	150kHz ~ 100MHz	Dec. 24, 2018	Dec. 23, 2019	Conduction (CO01-CB)
LISN	Schwarzbeck	NSLK 8127	8127647	9kHz ~ 30MHz	Jan. 11, 2019	Jan. 10, 2020	Conduction (CO01-CB)
Impedance Stabilization Network	Teseq	ISN T800	24557	150kHz ~ 230MHz	Nov. 13, 2018	Nov. 12, 2019	Conduction (CO01-CB)
COND Cable	Woken	Cable	Low cable-CO01	150kHz ~ 30MHz	May 22, 2018	May 21, 2019	Conduction (CO01-CB)
Software	Audix	E3	6.120210n	-	N.C.R.	N.C.R.	Conduction (CO01-CB)
10m Semi Anechoic Chamber	TDK	NSA	10CH01-CB	30MHz~1GHz 10m,3m	Jan. 31, 2019	Jan. 30, 2020	Radiation (10CH01-CB)
10m Semi Anechoic Chamber	TDK	VSWR	10CH01-CB	1GHz ~18GHz 3m	Mar. 16, 2019	Mar. 15, 2020	Radiation (10CH01-CB)
Pre-Amplifier	Agilent	8447D	2944A10783	9kHz ~ 1.3GHz	Mar. 12, 2019	Mar. 11, 2020	Radiation (10CH01-CB)
Pre-Amplifier	Agilent	8447D	2944A10784	9kHz ~ 1.3GHz	Mar. 12, 2019	Mar. 11, 2020	Radiation (10CH01-CB)
Low Cable	Woken	SUCOFLEX 104	low cable-01	25MHz ~ 1GHz	Nov. 06, 2018	Nov. 05, 2019	Radiation (10CH01-CB)
High Cable	Woken	SUCOFLEX 104	low cable-02	25MHz ~ 1GHz	Nov. 06, 2018	Nov. 05, 2019	Radiation (10CH01-CB)
BILOG ANTENNA with 6dB Attenuator	TESEQ & EMC I	CBL6112D & N-6-06	37880 & AT-N0609	20MHz ~ 2GHz	Aug. 27, 2018	Aug. 26, 2019	Radiation (10CH01-CB)
Log Antenna	Schwarzbeck	VUSLP 9111	247	200MHz ~ 1GHz	May 22, 2018	May 21, 2019	Radiation (10CH01-CB)
EMI Test Receiver	Rohde&Schwarz	ESCI	100186	9kHz ~ 3GHz	Jul. 10, 2018	Jul. 09, 2019	Radiation (10CH01-CB)
Spectrum Analyzer	Rohde&Schwarz	FSV30	101026	9kHz ~ 30GHz	Feb. 22, 2019	Feb. 21, 2020	Radiation (10CH01-CB)
Horn Antenna	ESCO	3117	00081283	1GHz ~ 18GHz	Dec. 11, 2018	Dec. 10, 2019	Radiation (10CH01-CB)
Amplifier	Agilent	8449B	3008A02660	1GHz ~ 26.5GHz	May 23, 2018	May 22, 2019	Radiation (10CH01-CB)



CABLE(1~40G)	Woken	SUCOFLEX 104	high cable-01	1GHz ~ 40GHz	Nov. 06, 2018	Nov. 05, 2019	Radiation (10CH01-CB)
Software	Audix	E3	6.120210m	-	N.C.R.	N.C.R.	Radiation (10CH01-CB)

※ Calibration Interval of instruments listed above is one year.

※ N.C.R. means Non-Calibration required.



<EMS>

Instrument	Manufacturer	Model No.	Serial No.	Characteristics	Calibration Date	Calibration Due Date	Remark
Harmonic/ Flicker	Teseq	CCN 1000-1	1306A00130	N/A	Feb. 25, 2019	Feb. 24, 2020	Harmonic/ Flicker
Software	Teseq	WIN2100V3	-	-	N.C.R.	N.C.R.	Harmonic/ Flicker
ESD Generator	NoiseKen	ESS-B3011	ESS1233481	Air: 0 kV ~ 30kV, Contact: 0kV ~ 30kV	Feb. 21, 2019	Feb. 20, 2020	ESD
Log-Periodic Antenna	AR	AT1080	0323130	80MHz ~ 1GHz	N.C.R.	N.C.R.	RS
Signal generator	R&S	SMB100A	180647	100kHz ~ 20GHz	Feb.13, 2019	Feb.12, 2020	RS
RF Power Amplifier	TESEQ	CBA 1G-300B	W2290-0518	80MHz ~ 1GHz 300W	N.C.R.	N.C.R.	RS
EPM Series Power Meter	Keysight	N1914A	MY57390002	9 kHz ~ 110 GHz	Dec. 24, 2018	Dec. 23, 2019	RS
Avg Power Sensor	Keysight	E9304A	MY57380004	9 kHz ~ 6 GHz	Dec. 24, 2018	Dec. 23, 2019	RS
Avg Power Sensor	Keysight	E9304A	MY57370003	9 kHz ~ 6 GHz	Dec. 24, 2018	Dec. 23, 2019	RS
RF-SWITCH NETWORK	TESEQ	RFB 2000	46748	N/A	N.C.R.	N.C.R.	RS
Dual Directional Couplers	AR	DC 6180A	0322837	80MHz ~ 1GHz	N.C.R.	N.C.R.	RS
Software	Audix	i2	Version:5	N/A	N.C.R.	N.C.R.	RS
Isotropic Probe	ETS-LINDGRE N	HI-6105	00130664	100kHz-6GHz	Oct. 31, 2018	Oct. 30, 2019	RS
Surge/EFT/Dip Generator	Teseq AG	NSG 3060	1534	Surge 0 ~ 6kV EFT 0 kV ~ 4.4 kV Dip 100~240V/ 50Hz /60Hz	Apr. 16, 2019	Apr. 15, 2020	Surge EFT Dip
Burst/EFT Dataline Coupling Clamp	Teseq AG	CDN 3425	1776	0.25kV~4kV	Apr. 16, 2019	Apr. 15, 2020	EFT
Surge Coupling Decoupling Network	Teseq GebH	CDN HSS-2	34283	0.25kV~4kV	Apr. 10, 2019	Apr. 09, 2020	Surge
Software	Teseq AG	NSG3000	-	-	N.C.R.	N.C.R.	Surge/ EFT/Dip



RF-Generator	Teseq GmbH	NSG 4070B-30	035084	150kHz~230MHz	Apr. 14, 2019	Apr. 13, 2020	CS
Coupling decoupling network	Teseq GmbH	CDN M016	34634	150kHz~80MHz	Apr. 16, 2019	Apr. 15, 2020	CS
Coupling decoupling network	Teseq GmbH	CDN T8-10	46729	150kHz~230MHz	Jul. 24, 2018	Jul. 23, 2019	CS
Software	Tesq	NSG4070	030593.V1.28	-	N.C.R.	N.C.R.	CS
Magnetic field Immunity Loop	FCC	F-1000-4-8/9/1 0-L-1AM	04014,04017	30A//CONTINUOUS, 100A/2Hrs, 230A/30SEC	Jul. 31, 2018	Jul. 30, 2019	Magnetic

※ Calibration Interval of instruments listed above is one year.

※ N.C.R. means Non-Calibration required.



18. Uncertainty of Test Site

Test Items	Uncertainty	Remark
Conducted Emissions	2.0 dB	Confidence levels of 95%
Radiated Emissions below 1GHz	4.6 dB	Confidence levels of 95%
Radiated Emissions above 1GHz	5.4 dB	Confidence levels of 95%



Immunity Test Measurement Uncertainty

Electrostatic Discharge Immunity (ESD)

Negative Discharge Current

From Standard				From calibration certificate						
2kV	First Peak Current	Current at 30ns	Current at 60ns	Measured First Peak Current	1st Peak Worst case +5%	Measured Current at 30ns	30ns Worst case +5%	Measured Current at 60ns	60ns Worst case +5%	
Nominal	7.5	4.0	2.0	Positive	7.5	7.9	4.1	4.3	2.2	2.3
Min.	6.4	2.8	1.4	Negative	7.5	7.9	4.0	4.2	2.0	2.1
Max.	8.6	5.2	2.6	Min.		6.4		2.8		1.4
Tolerance in %	0.2	0.3	0.3	Max.		8.6		5.2		2.6

4kV	First Peak Current	Current at 30ns	Current at 60ns	Measured First Peak Current	1st Peak Worst case +5%	Measured Current at 30ns	30ns Worst case +5%	Measured Current at 60ns	60ns Worst case +5%	
Nominal	15.0	8.0	4.0	Positive	13.5	14.1	7.9	8.3	4.0	4.2
Min.	12.8	5.6	2.8	Negative	13.9	14.6	7.9	8.3	4.0	4.2
Max.	17.3	10.4	5.2	Min.		12.8		5.6		2.8
Tolerance in %	0.2	0.3	0.3	Max.		17.3		10.4		5.2

6kV	First Peak Current	Current at 30ns	Current at 60ns	Measured First Peak Current	1st Peak Worst case -5%	Measured Current at 30ns	30ns Worst case +5%	Measured Current at 60ns	60ns Worst case +5%	
Nominal	22.5	12.0	6.0	Positive	21.2	22.2	12.2	12.9	6.3	6.7
Min.	19.1	8.4	4.2	Negative	21.3	22.3	12.3	12.9	6.2	6.6
Max.	25.9	15.6	7.8	Min.		19.1		8.4		4.2
Tolerance in %	0.2	0.3	0.3	Max.		25.9		15.6		7.8

8kV	First Peak Current	Current at 30ns	Current at 60ns	Measured First Peak Current	1st Peak Worst case -5%	Measured Current at 30ns	30ns Worst case +5%	Measured Current at 60ns	60ns Worst case +5%	
Nominal	30.0	16.0	8.0	Positive	29.5	31.0	17.1	18.0	8.8	9.3
Min.	25.5	11.2	5.6	Negative	29.3	30.8	16.9	17.7	8.2	8.6
Max.	34.5	20.8	10.4	Min.		25.5		11.2		5.6
Tolerance in %	0.2	0.3	0.3	Max.		34.5		20.8		10.4



Negative Discharge Voltage

Standard Parameters					Calculated Range		
Indicated Voltage (kV)	Polarity	Tolerance (%)	Max. (kV)	Min. (kV)	Calibration (kV)	Max. (kV)	Min. (kV)
2	Positive	15.0	2.3	1.7	2.0	2.0	2.0
	Negative	15.0	2.3	1.7	-2.1	-2.1	-2.1
4	Positive	15.0	4.6	3.4	4.1	4.1	4.1
	Negative	15.0	4.6	3.4	-4.1	-4.1	-4.1
6	Positive	15.0	6.9	5.1	6.1	6.1	6.1
	Negative	15.0	6.9	5.1	-6.1	-6.1	-6.1
8	Positive	15.0	9.2	6.8	8.1	8.1	8.1
	Negative	15.0	9.2	6.8	-8.2	-8.2	-8.2
15	Positive	15.0	17.3	12.8	15.3	15.3	15.3
	Negative	15.0	17.3	12.8	-15.0	-15.0	-15.0

It has been demonstrated that the ESD generator meets the specified requirements in the standard with at least a 95% confidence.



Radio Frequency Electromagnetic Field Immunity (RS)
VSG

Table with 3 columns: Freq (MHz), Reading (Hz), Uncertainty. Row 1: 10, 9999998.369, 1.0E-09

Table with 9 columns: Freq (MHz), Reading (MHz), Uncertainty, Freq (MHz), Reading (MHz), Uncertainty, Freq (MHz), Reading (MHz), Uncertainty. Multiple rows of frequency settings.

Table with 9 columns: Freq (MHz), Reading (dBm), Uncertainty (dB), Freq (MHz), Reading (dBm), Uncertainty (dB), Freq (MHz), Reading (dBm), Uncertainty (dB). Title: Frequency response : ALC on Level +11dBm

Table with 9 columns: Freq (MHz), Reading (dBm), Uncertainty (dB), Freq (MHz), Reading (dBm), Uncertainty (dB), Freq (MHz), Reading (dBm), Uncertainty (dB). Title: Frequency response : ALC on Level 0dBm



Frequency response : ALC on Level -20dBm								
Freq (MHz)	Reading (dBm)	Uncertainty (dB)	Freq (MHz)	Reading (dBm)	Uncertainty (dB)	Freq (MHz)	Reading (dBm)	Uncertainty (dB)
0.2	-20.01	0.1	1100	-19.98	0.1	3000	-19.97	0.1
1.0	-20	0.1	1210	-19.96	0.1	3250	-19.98	0.1
5.0	-20	0.1	1250	-19.97	0.1	3500	-20.01	0.1
5.1	-20.01	0.1	1500	-19.97	0.1	3750	-20	0.1
76	-19.98	0.1	1700	-19.97	0.1	4000	-19.97	0.1
77	-19.98	0.1	1800	-19.96	0.1	4250	-19.98	0.1
151	-19.96	0.1	2010	-19.97	0.1	4500	-19.98	0.1
255	-19.98	0.1	2100	-19.99	0.1	4750	-19.97	0.1
302	-20	0.1	2200	-19.97	0.1	5000	-19.99	0.1
605	-19.98	0.1	2400	-19.96	0.1	5250	-19.98	0.1
606	-19.97	0.1	2655	-19.96	0.1	5500	-19.97	0.1
725	-19.99	0.1	2660	-19.95	0.1	5750	-19.98	0.1
970	-19.97	0.1	2800	-19.97	0.1	6000	-20	0.1

Attenuator mode fixed Freq 100MHz REF 3.00dBm=(0dB)			Attenuator mode fixed Freq 5500MHz REF 3.00dBm=(0dB)		
ATT (0dB)	Reading (dB)	Uncertainty (dB)	ATT (0dB)	Reading (dB)	Uncertainty (dB)
-5	-5.01	0.1	-5	-5.02	0.1
-10.0	-10.01	0.1	-10.0	-10.04	0.1
-15.0	-15.01	0.1	-15.0	-15.03	0.1
-20	-20.02	0.1	-20	-20.07	0.1

Level uncertainty Freq 100MHz								
ATT (0dB)	Reading (dB)	Uncertainty (dB)	ATT (0dB)	Reading (dB)	Uncertainty (dB)	ATT (0dB)	Reading (dB)	Uncertainty (dB)
11	11.02	0.1	-20	-19.97	0.1	-70.0	-70.02	0.1
5.0	5	0.1	-25	-24.97	0.1	-80	-80.01	0.1
0.0	0.03	0.1	-30.0	-29.97	0.1	-90	-90.02	0.1
-5	-4.97	0.1	-40	-39.97	0.1	-100.0	-100.02	0.1
-10	-9.97	0.1	-50	-49.98	0.1	-110.0	-109.97	0.1
-15.0	-14.97	0.1	-60.0	-60.02	0.1	-120	-119.86	0.1

Power Sensor

Power Sensor Cal. Test : @Input 0.00dBm								
Freq (MHz)	Reading (dBm)	Uncertainty (%)	Freq (MHz)	Reading (dBm)	Uncertainty (%)	Freq (MHz)	Reading (dBm)	Uncertainty (%)
0.009	-0.01	3.6	100	-0.01	3.6	4000	-0.02	3.6
0.1	-0.01	3.6	500	-0.02	3.6	5000	-0.03	3.6
1.0	-0.01	3.6	1000	-0.02	3.6	6000	-0.03	3.6
10	-0.02	3.6	2000	-0.02	3.6			
50	-0.01	3.6	3000	-0.02	3.6			



Power Meter

Instrument Accuracy Test Check								
Range Calibrator Setting (CHA)	Reading	Uncertainty (%)	Range Calibrator Setting (CHA)	Reading	Uncertainty (%)	Range Calibrator Setting (CHA)	Reading	Uncertainty (%)
3uW	3.16uW	0.4	300uW	0.316mW	0.4	30mW	31.8mW	0.4
10uW	9.99uW	0.4	1mW	1mW	0.4	100mW	101.2mW	0.4
30uW	31.6uW	0.4	3mW	3.15mW	0.4			
100uW	99.9uW	0.4	10mW	10.03mW	0.4			

Instrument Accuracy Test Check								
Range Calibrator Setting (CHB)	Reading	Uncertainty (%)	Range Calibrator Setting (CHB)	Reading	Uncertainty (%)	Range Calibrator Setting (CHB)	Reading	Uncertainty (%)
3uW	3.14uW	0.4	300uW	0.316mW	0.4	30mW	31.8mW	0.4
10uW	9.99uW	0.4	1mW	1mW	0.4	100mW	101.2mW	0.4
30uW	31.5uW	0.4	3mW	3.15mW	0.4			
100uW	99.8uW	0.4	10mW	10.03mW	0.4			

Power REF Level Test Check : 50MHz 1mW		
Actual	Limits	Uncertainty(%)
0.999mW	1.000±0.015mW	2.9

It has been demonstrated that the RS generator meets the specified requirements in the standard with at least a 95% confidence.



**Electrical Fast Transient/Burst Immunity (EFT/BURST)
Voltage**

Impedance	Voltage Setting(V)	Expected (V)	Actual (V)	Uncertainty (%)	T1	Uncertainty (%)	T2	Uncertainty (%)
50Ω	250	125	126	6.1	3.71	5.1	50.86	5.1
50Ω	500	250	253	6.2	4.37	5.1	47.98	5.1
50Ω	1000	500	516	6.0	4.3	5.1	45.6	5.1
50Ω	2000	1000	1035	6.0	4.35	5.1	44.99	5.1
50Ω	4000	2000	2042	5.9	5.13	5.1	45.49	5.1
50Ω	-500	-250	-248	6.0	4.02	5.1	49.51	5.1
50Ω	-1000	-500	-516	6.0	4.48	5.1	48.03	5.1
50Ω	-2000	-1000	-1020	6.0	4.5	5.1	44.32	5.1
50Ω	-4000	-2000	-2032	6.0	4.52	5.1	43.39	5.1
1kΩ	500	500	470	6.0	4.34	5.1	93.68	5.1
1kΩ	1000	1000	964	6.3	4.36	5.1	72.77	5.1
1kΩ	2000	2000	1929	6.0	4.38	5.1	72.19	5.1
1kΩ	4000	4000	3776	6.0	4.9	5.1	81.94	5.1
1kΩ	-500	-500	-447	6.2	4.39	5.1	83.53	5.1
1kΩ	-1000	-1000	-946	6.0	4.38	5.1	76.24	5.1
1kΩ	-2000	-2000	-1876	6.0	4.52	5.1	73.84	5.1
1kΩ	-4000	-4000	-3740	6.0	5.18	5.1	79.76	5.1

EFT Repetition Frequency (Voltage @ 1 kV)

Setting (kHz)	Actual (kHz)	Uncertainty (%)	Tolerance (%)
2.5	2.5	5.1	20%
5	5.01	5.1	20%
100	99.96	5.1	20%

Burst Duration (Voltage @ 1 kV)

Setting (ms)	Repetition Freq. (kHz)	Actual (ms)	Uncertainty (%)	Tolerance (%)
15	5	14.81	5.1	20%
0.75	100	0.74	5.1	20%

Burst Period (Voltage @ 1 kV)

Setting (ms)	Repetition Freq. (kHz)	Actual (ms)	Uncertainty (%)	Tolerance (%)
300	5	300.6	5.1	20%
300	100	299.8	5.1	20%

It has been demonstrated that the EFT/BURST generator meets the specified requirements in the standard with at least a 95% confidence.



Surge Immunity

Open Circuit Output Voltage Waveform check:

Impedance	Voltage Setting(V)	Actual (V)	Uncertainty (%)	T3	Uncertainty (%)	T4	Uncertainty (%)
L-N 2Ω	500	476	5.6	1.29	4.6	54.23	4.6
L-N 2Ω	4000	3831	5.6	1.16	4.6	52.31	4.6
L-N 2Ω	-500	-479	5.6	1.3	4.6	54.13	4.6
L-N 2Ω	-4000	-3885	5.6	1.16	4.6	52.07	4.6
L-G 12Ω	500	452	5.6	1.33	4.6	30.31	4.6
L-G 12Ω	6000	5640	5.6	0.97	4.6	29	4.6
L-G 12Ω	-500	-466	5.6	1.31	4.6	30.22	4.6
L-G 12Ω	-6000	-6038	5.6	1.21	4.6	28.53	4.6
N-G 12Ω	500	461	5.6	1.32	4.6	30.41	4.6
N-G 12Ω	6000	5609	5.6	0.86	4.6	29.6	4.6
N-G 12Ω	-500	-460	5.6	1.33	4.6	30.25	4.6
N-G 12Ω	-6000	-5694	5.6	1.09	4.6	28.72	4.6
Impulse	500	473	5.6	1.45	4.6	56.27	4.6
Impulse	6000	5778	5.6	1.19	4.6	54.83	4.6
Impulse	-500	-472	5.6	1.43	4.6	58.54	4.6
Impulse	-6000	-5860	5.6	1.21	4.7	54.49	4.6

Short Circuit Output Voltage Waveform check:

Impedance	Voltage Setting(V)	Actual (V)	Uncertainty (%)	T5	Uncertainty (%)	T6	Uncertainty (%)
L-N 2Ω	500	225	4.8	7.2	3.4	19.15	3.4
L-N 2Ω	4000	1884	4.8	7.1	3.4	19.63	3.4
L-N 2Ω	-500	-225	4.8	7.06	3.4	19.45	3.4
L-N 2Ω	-4000	-1867	4.8	7.16	3.4	19.71	3.4
L-G 12Ω	500	42	4.8	1.98	3.4	25.35	3.4
L-G 12Ω	6000	502	4.8	2.28	3.4	24.62	3.4
L-G 12Ω	-500	-39	4.8	2.01	3.4	24.87	3.4
L-G 12Ω	-6000	-504	4.8	2.32	3.4	24.74	3.4
N-G 12Ω	500	39	4.8	2.67	3.4	25.28	3.4
N-G 12Ω	6000	495	4.8	2.79	3.4	25.37	3.4
N-G 12Ω	-500	-39	4.8	2.62	3.4	25.45	3.4
N-G 12Ω	-6000	-493	4.8	2.8	3.4	25.4	3.4
Impulse	500	225	4.8	7.43	3.4	19.52	3.4
Impulse	6000	2946	4.8	7.32	3.4	19.27	3.4
Impulse	-500	-226	4.8	7.39	3.4	19.52	3.4
Impulse	-6000	-2948	4.8	7.29	3.4	19.31	3.4

It has been demonstrated that the Surge generator meets the specified requirements in the standard with at least a 95% confidence.



Conducted Disturbances Induced by Radio-Frequency Field Immunity (CS)

RF Frequency Measurement Check		RF Generator Second Harmonic Check
Reading	Standard	Harmonic (dBc)
9.000 kHz	8.999960682 kHz	-48.6
50.000 kHz	49.99978775 kHz	-44.6
100.000 kHz	99.99957519 kHz	-45.6
1.000000 MHz	0.99999716 MHz	-44.3
5.000000 MHz	4.99997873 MHz	-45.6
10.000000 MHz	9.99995741 MHz	-47.5
50.000000 MHz	49.9997877 MHz	-48.3
100.000000 MHz	99.9995757 MHz	-46.2
500.000000 MHz	499.997880 MHz	-47.1
1000.000000 MHz	999.995761 MHz	-48.5

RF Generator AM Modulation Measurement Check (1 kHz ; 80 %)			
Frequency	Mod. Freq.	Reading	Standard
100.000 kHz	1 kHz	80.00%	79.90%
1.000000 MHz	1 kHz	80.00%	80.90%
5.000000 MHz	1 kHz	80.00%	81.00%
10.000000 MHz	1 kHz	80.00%	80.70%
50.000000 MHz	1 kHz	80.00%	80.90%
100.000000 MHz	1 kHz	80.00%	80.80%
500.000000 MHz	1 kHz	80.00%	81.50%
1000.000000 MHz	1 kHz	80.00%	80.90%

RF Generator Response and Accuracy Measurement Check		
Frequency	Reading (dBm)	Standard (dBm)
9.000 kHz	0	0.17
50.000 kHz	0	0.19
100.000 kHz	0	0.22
1.000000 MHz	0	0.25
5.000000 MHz	0	0.23
10.000000 MHz	0	0.19
50.000000 MHz	0	-0.14
50.000000 MHz	-10	-10.28
50.000000 MHz	-20	-20.29
50.000000 MHz	-30	-30.28
50.000000 MHz	-40	-40.36
50.000000 MHz	-50	-50.42
100.000000 MHz	0	0.16
500.000000 MHz	0	0.16
1000.000000 MHz	0	0.01

RF Power Meter Measurement Check			
Frequency (MHz)	Standard (dBm)	Reading (dBm)	
CH 1	50	10	9.96
CH 1	50	0	-0.03
CH 1	50	-10	-10.05
CH 1	50	-15	-15.04
CH 2	50	10	9.92
CH 2	50	0	-0.08
CH 2	50	-10	-10.05
CH 2	50	-15	-15.09



Power Amplifier Gain Flatness Measurement		Power Amplifier Standard Measurement (Input: 10 dBm)		Power Amplifier Second Harmonic Measurement Check
Frequency	Reading (dB)	Result (dBm)	Spec. (dBm)	Reading (dBc)
150.000 kHz	48.9	46.7	> 44.77	-47.5
1.000000 MHz	49.3	46.9	> 44.77	-47.2
5.000000 MHz	49.4	47.1	> 44.77	-49.5
10.000000 MHz	49.4	47.1	> 44.77	-48.7
50.000000 MHz	49	47.1	> 44.77	-49.2
100.000000 MHz	48.4	46.9	> 44.77	-48
200.000000 MHz	48	45.8	> 44.77	-53.5
2300.000000 MHz	48.4	45.3	> 44.77	-55.7

Uncertainty: Frequency: 1.9×10^{-9}
Linear: 0.9 dB
RF Power Level: 1.2 dB
Harmonic: 2.0 dB

It has been demonstrated that the CS generator meets the specified requirements in the standard with at least a 95% confidence.



**Power Frequency Magnetic Field Immunity
AC Current Accuracy Check**

Freq.(Hz)	Range (A)	Standard (A)	Reading (A)	Uncertainty (%)
50	0~10	1.062	1.02	0.3
50	0~10	3.143	3.03	0.3
50	0~10	5.177	5.03	0.3
50	0~10	10.406	10.15	0.3
50	10~125	10.65	10	0.3
50	10~125	31.11	30.2	0.3
50	10~125	51.36	50.1	0.3
50	10~125	101.8	100	0.3
60	0~10	1.08	1	0.3
60	0~10	3.081	3.02	0.3
60	0~10	5.093	5.03	0.3
60	0~10	10.275	10.18	0.3
60	10~125	10.54	9.9	0.3
60	10~125	30.81	30.02	0.3
60	10~125	51.05	50.3	0.3
60	10~125	101.04	100.2	0.3

Magnetic Measurement Check : (@50Hz)

Range (A)	Standard (A/m)	Reading (A)	Uncertainty (%)
0~10	1	1.04	1.0
0~10	3	3.22	1.0
0~10	10	10.89	1.0
10~125	10	11.3	1.0
10~125	30	33.6	1.0
10~125	100	104.8	1.0

It has been demonstrated that the PFMF the specified requirements in the standard with at least a 95% confidence.



Voltage Dips and Voltage Interruptions Immunity

PQF Measurement: (Input Voltage: 230V/50Hz)

Level	Load	Actual (V)	Uncertainty (mV/V)	Tolerance (%)
80%	100Ω	180.7	17	184 +/- 5%
70%	100Ω	158.3	17	161 +/- 5%
40%	100Ω	89.3	17	92 +/- 5%
0%	100Ω	6.8	17	-

VAR Check: (Input Voltage: 230V/50Hz)

Level	Load	Actual (V)	Uncertainty (mV/V)	Tolerance (%)
80%	100Ω	181.3	17	184 +/- 5%
70%	100Ω	159.2	17	161 +/- 5%
40%	100Ω	90.7	17	92 +/- 5%
0%	100Ω	6.7	17	-

It has been demonstrated that the Dip generator meets the specified requirements in the standard with at least a 95% confidence.



AC Power Port Conducted Emission Result

Appendix A

Test Mode	Mode 1	Frequency Range	0.15 MHz to 30 MHz
------------------	--------	------------------------	--------------------

Line

03/05/2019

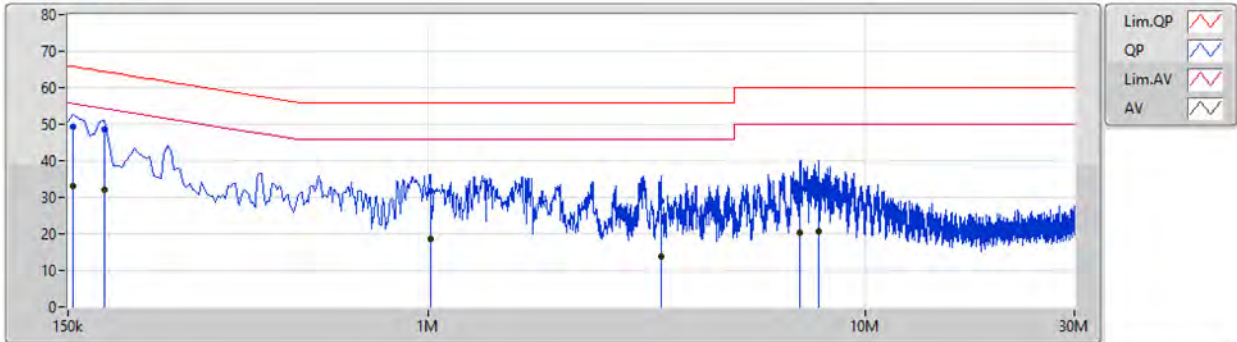

Type	Freq (Hz)	Level (dBuV)	Limit (dBuV)	Margin (dB)	Factor (dB)	Condition	Comment	Raw (dBuV)	AF (dB)	CL (dB)	AT (dB)
QP	154.5k	49.27	65.75	-16.48	10.00	Line	-	39.27	0.05	0.16	9.79
AV	154.5k	33.02	55.75	-22.73	10.00	Line	-	23.02	0.05	0.16	9.79
QP	181.5k	48.57	64.41	-15.84	10.00	Line	"Worst"	38.57	0.06	0.15	9.79
AV	181.5k	32.17	54.41	-22.24	10.00	Line	-	22.17	0.06	0.15	9.79
QP	1.01M	31.62	56.00	-24.38	10.09	Line	-	21.53	0.07	0.20	9.82
AV	1.01M	18.58	46.00	-27.42	10.09	Line	-	8.49	0.07	0.20	9.82
QP	3.408M	28.83	56.00	-27.17	10.07	Line	-	18.76	0.11	0.15	9.81
AV	3.408M	13.75	46.00	-32.25	10.07	Line	-	3.68	0.11	0.15	9.81
QP	7.089M	31.80	60.00	-28.20	10.20	Line	-	21.60	0.18	0.14	9.88
AV	7.089M	20.29	50.00	-29.71	10.20	Line	-	10.09	0.18	0.14	9.88
QP	7.791M	33.47	60.00	-26.53	10.22	Line	-	23.25	0.19	0.14	9.89
AV	7.791M	20.78	50.00	-29.22	10.22	Line	-	10.56	0.19	0.14	9.89



Neutral

03/05/2019

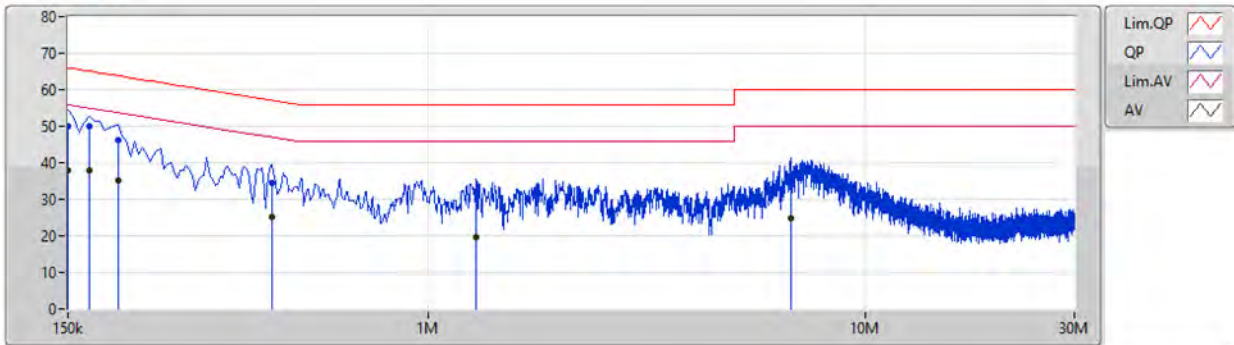

Type	Freq (Hz)	Level (dBuV)	Limit (dBuV)	Margin (dB)	Factor (dB)	Condition	Comment	Raw (dBuV)	AF (dB)	CL (dB)	AT (dB)
QP	150k	50.13	66.00	-15.87	9.99	Neutral	-	40.14	0.04	0.16	9.79
AV	150k	37.83	56.00	-18.17	9.99	Neutral	-	27.84	0.04	0.16	9.79
QP	168k	50.05	65.06	-15.01	9.98	Neutral	"Worst"	40.07	0.04	0.15	9.79
AV	168k	37.78	55.06	-17.28	9.98	Neutral	-	27.80	0.04	0.15	9.79
QP	195k	46.34	63.82	-17.48	9.97	Neutral	-	36.37	0.04	0.14	9.79
AV	195k	35.34	53.82	-18.48	9.97	Neutral	-	25.37	0.04	0.14	9.79
QP	438k	34.55	57.11	-22.56	9.98	Neutral	-	24.57	0.04	0.13	9.81
AV	438k	25.12	47.11	-21.99	9.98	Neutral	-	15.14	0.04	0.13	9.81
QP	1.289M	32.04	56.00	-23.96	10.09	Neutral	-	21.95	0.06	0.21	9.82
AV	1.289M	19.53	46.00	-26.47	10.09	Neutral	-	9.44	0.06	0.21	9.82
QP	6.734M	35.55	60.00	-24.45	10.16	Neutral	-	25.39	0.15	0.14	9.87
AV	6.734M	24.78	50.00	-25.22	10.16	Neutral	-	14.62	0.15	0.14	9.87



Telecommunication Port Conducted Emission Result

Appendix B

Test Mode	Mode 1, LAN Port / 1000Mbps	Frequency Range	0.15 MHz to 30 MHz
------------------	-----------------------------	------------------------	--------------------

03/05/2019

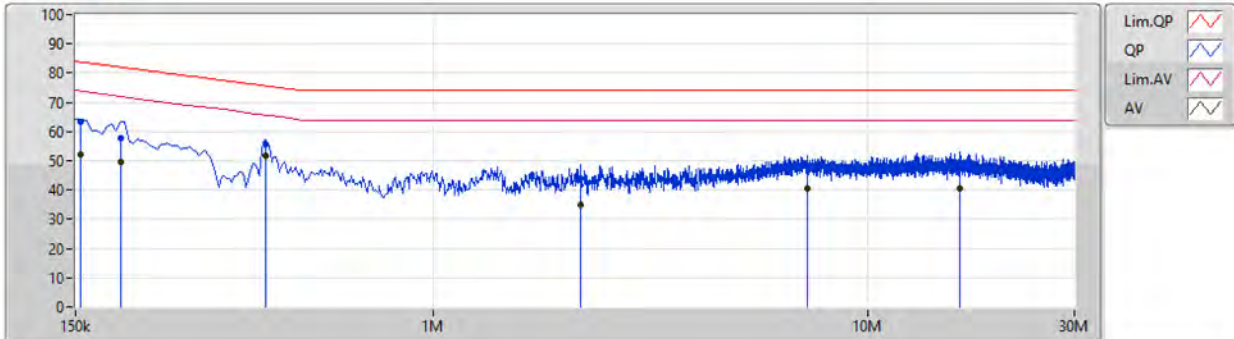

Type	Freq (Hz)	Level (dBuV)	Limit (dBuV)	Margin (dB)	Factor (dB)	Condition	Comment	Raw (dBuV)	AF (dB)	CL (dB)	AT (dB)
QP	154.5k	63.34	83.75	-20.41	20.01	ISN	-	43.33	10.06	0.16	9.79
AV	154.5k	52.21	73.75	-21.54	20.01	ISN	-	32.20	10.06	0.16	9.79
QP	190.5k	57.87	82.01	-24.14	19.87	ISN	-	38.00	9.94	0.14	9.79
AV	190.5k	49.47	72.01	-22.54	19.87	ISN	-	29.60	9.94	0.14	9.79
QP	411k	55.58	75.63	-20.05	19.63	ISN	-	35.95	9.70	0.12	9.81
AV	411k	51.61	65.63	-14.02	19.63	ISN	"Worst"	31.98	9.70	0.12	9.81
QP	2.184M	44.04	74.00	-29.96	19.55	ISN	-	24.49	9.50	0.22	9.83
AV	2.184M	34.97	64.00	-29.03	19.55	ISN	-	15.42	9.50	0.22	9.83
QP	7.287M	47.71	74.00	-26.29	19.48	ISN	-	28.23	9.46	0.14	9.88
AV	7.287M	40.46	64.00	-23.54	19.48	ISN	-	20.98	9.46	0.14	9.88
QP	16.283M	47.28	74.00	-26.72	19.78	ISN	-	27.50	9.62	0.22	9.94
AV	16.283M	40.54	64.00	-23.46	19.78	ISN	-	20.76	9.62	0.22	9.94



Radiated Emission below 1GHz Result

Appendix C.1

Test Mode	Mode 1	Frequency Range	30 MHz to 1,000 MHz
------------------	--------	------------------------	---------------------

Vertical 30 MHz to 200 MHz

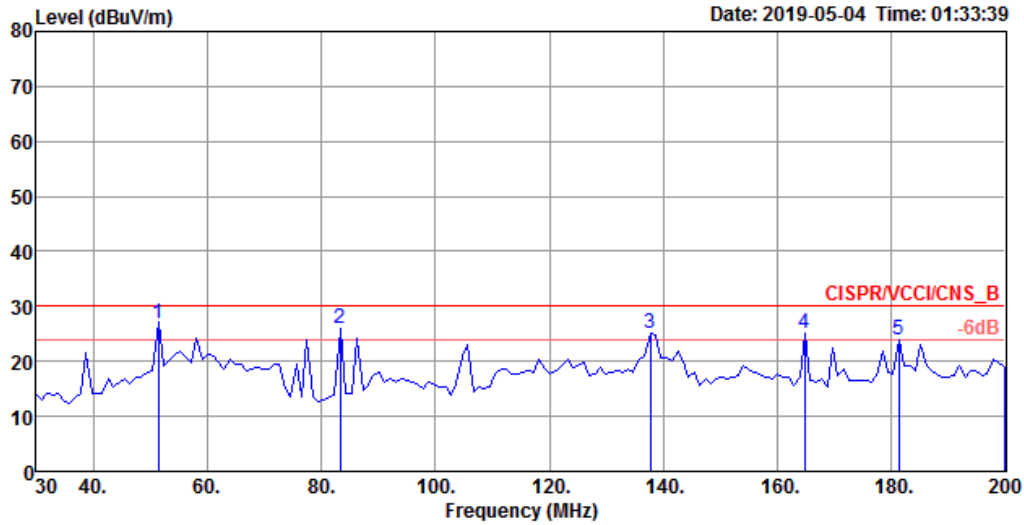

	Freq	Level	Limit	Over	Read	Preamp	Antenna	Cable	Remark	A/Pos	T/Pos	Pol/Phase
	MHz	dBuV/m	dBuV/m	dB	dBuV	dB	dB/m	dB		cm	deg	
1	51.34	27.00	30.00	-3.00	44.30	28.34	9.93	1.11	Peak	100	5	VERTICAL
2	83.35	25.92	30.00	-4.08	43.32	28.21	9.03	1.78	Peak	100	1	VERTICAL
3	137.67	25.00	30.00	-5.00	38.87	27.93	11.53	2.53	Peak	100	8	VERTICAL
4	164.83	25.05	30.00	-4.95	37.70	27.77	12.29	2.83	Peak	100	33	VERTICAL
5	181.32	23.81	30.00	-6.19	35.30	27.70	13.12	3.09	Peak	100	33	VERTICAL



Vertical 200 MHz to 1,000 MHz

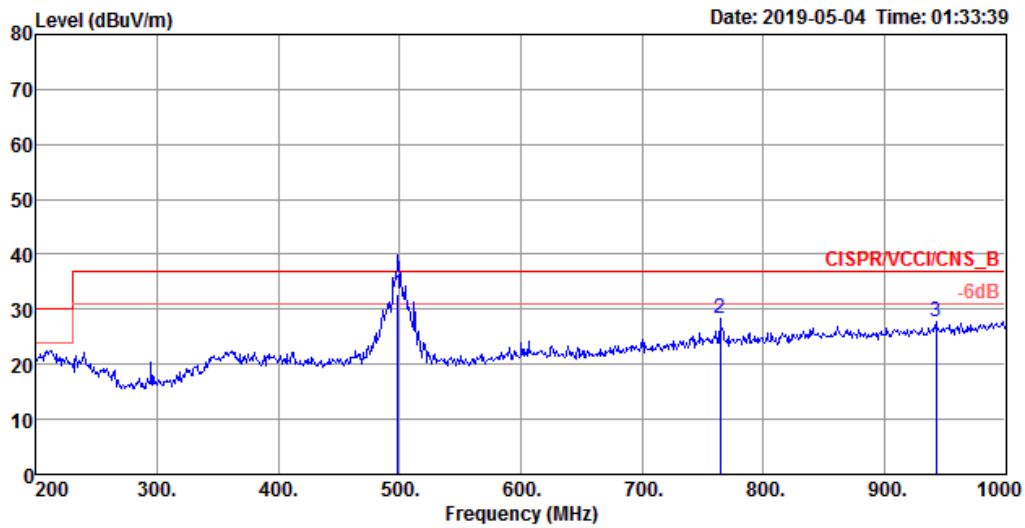

	Freq	Level	Limit	Over	Read	Preamp	Antenna	Cable	Remark	A/Pos	T/Pos	Pol/Phase
	MHz	dBuV/m	dBuV/m	dB	dBuV	dB	dB/m	dB		cm	deg	
1	498.51	32.79	37.00	-4.21	38.80	28.22	17.59	4.62	QP	100	282	VERTICAL
2	764.29	28.30	37.00	-8.70	29.33	27.55	20.73	5.79	Peak	300	357	VERTICAL
3	942.77	27.84	37.00	-9.16	25.87	26.72	22.22	6.47	Peak	300	114	VERTICAL



Horizontal 30 MHz to 200 MHz

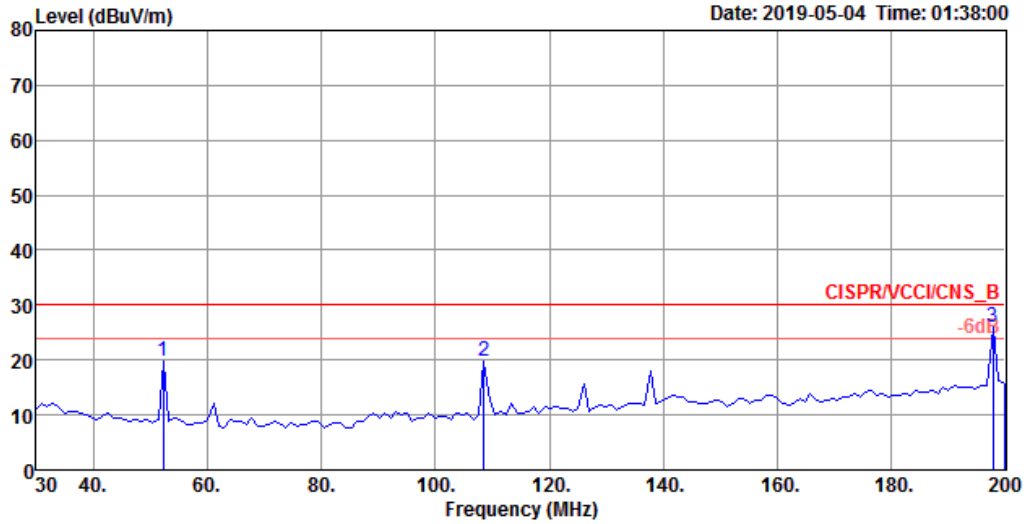

	Freq	Level	Limit	Over	Read	Preamp	Antenna	Cable		A/Pos	T/Pos	Pol/Phase
	MHz	dBuV/m	dBuV/m	dB	Level	Factor	Factor	Loss	Remark	cm	deg	
1	52.31	19.69	30.00	-10.31	37.02	28.34	9.89	1.12	Peak	100	298	HORIZONTAL
2	108.57	19.64	30.00	-10.36	35.59	28.01	10.02	2.04	Peak	100	174	HORIZONTAL
3	197.81	25.92	30.00	-4.08	36.10	27.63	14.29	3.16	Peak	100	284	HORIZONTAL



Horizontal 200 MHz to 1,000 MHz

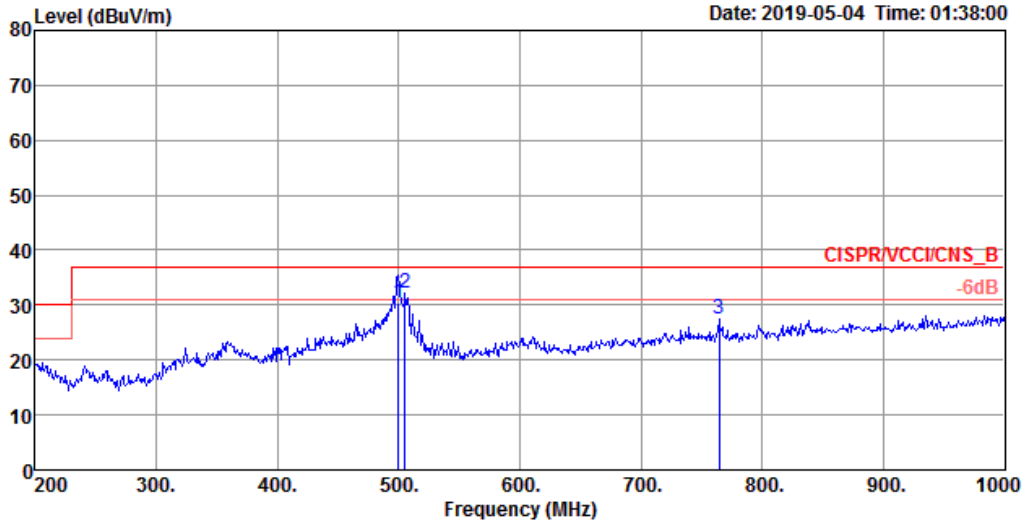

	Freq	Level	Limit	Over	Read	Preamp	Antenna	Cable		A/Pos	T/Pos	Pol/Phase
	MHz	dBuV/m	dBuV/m	dB	Level	Factor	Factor	Loss	Remark	cm	deg	
1	499.48	30.37	37.00	-6.63	36.37	28.23	17.60	4.63	QP	400	267	HORIZONTAL
2	505.30	32.08	37.00	-4.92	38.00	28.24	17.67	4.65	Peak	100	258	HORIZONTAL
3	764.29	27.37	37.00	-9.63	28.40	27.55	20.73	5.79	Peak	100	280	HORIZONTAL



Radiated Emission above 1GHz Result

Appendix C.2

Test Mode	Mode 1	Frequency Range	1,000 MHz to 6,000 MHz
------------------	--------	------------------------	------------------------

Vertical 1,000 MHz to 6,000 MHz

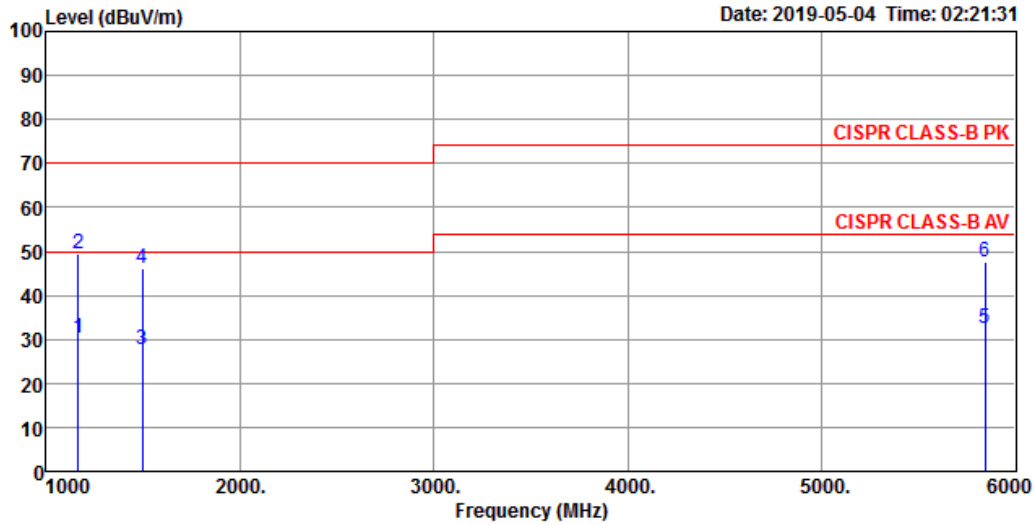

	Freq	Level	Limit	Over	Read	Preamp	Antenna	Cable	Remark	A/Pos	T/Pos	Pol/Phase
	MHz	dBuV/m	dBuV/m	dB	dBuV	dB	dB/m	dB		cm	deg	
1	1165.00	30.31	50.00	-19.69	35.57	36.35	28.20	2.89	Average	100	165	VERTICAL
2	1165.00	49.43	70.00	-20.57	54.69	36.35	28.20	2.89	Peak	100	165	VERTICAL
3	1495.00	27.85	50.00	-22.15	33.02	36.12	27.60	3.35	Average	100	31	VERTICAL
4	1495.00	46.17	70.00	-23.83	51.34	36.12	27.60	3.35	Peak	100	31	VERTICAL
5	5845.00	32.42	54.00	-21.58	25.97	36.32	35.40	7.37	Average	100	339	VERTICAL
6	5845.00	47.53	74.00	-26.47	41.08	36.32	35.40	7.37	Peak	100	339	VERTICAL



Horizontal 1,000 MHz to 6,000 MHz

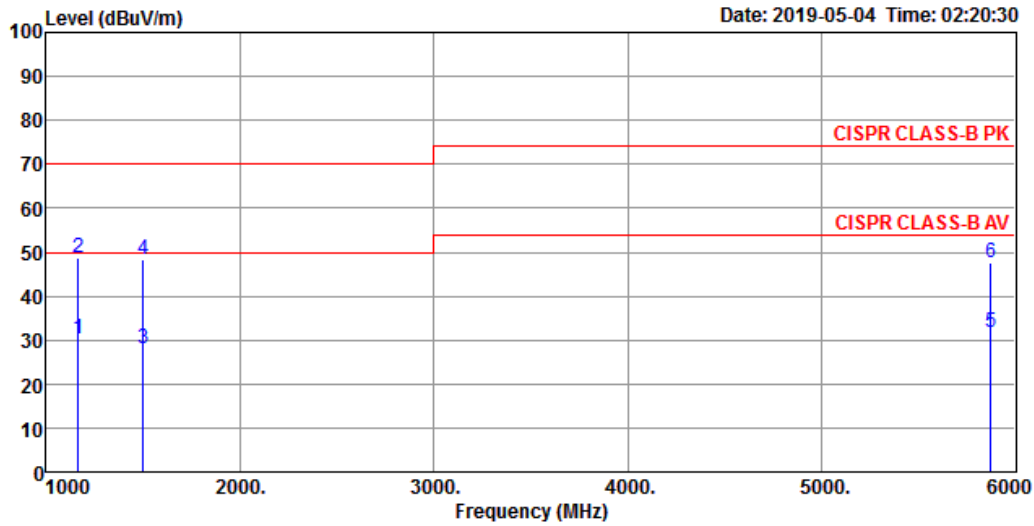

	Freq	Level	Limit	Over	Read	Preamp	Antenna	Cable		A/Pos	T/Pos	Pol/Phase
	MHz	dBuV/m	dBuV/m	dB	dBuV	dB	dB/m	dB	Remark	cm	deg	
1	1165.00	30.08	50.00	-19.92	35.34	36.35	28.20	2.89	Average	100	163	HORIZONTAL
2	1165.00	48.72	70.00	-21.28	53.98	36.35	28.20	2.89	Peak	100	163	HORIZONTAL
3	1500.00	28.21	50.00	-21.79	33.36	36.10	27.60	3.35	Average	100	29	HORIZONTAL
4	1500.00	48.43	70.00	-21.57	53.58	36.10	27.60	3.35	Peak	100	29	HORIZONTAL
5	5875.00	31.79	54.00	-22.21	25.22	36.32	35.53	7.36	Average	100	333	HORIZONTAL
6	5875.00	47.51	74.00	-26.49	40.94	36.32	35.53	7.36	Peak	100	333	HORIZONTAL



Test Mode	Mode 1
Highest parameter values during test:	
V_RMS (Volts): 230.42	Frequency(Hz): 50.00
I_Peak (Amps): 0.469	I_RMS (Amps): 0.091
I_Fund (Amps): 0.033	Crest Factor: 5.461
Power (Watts): 7.6	Power Factor: 0.371
<i>Note: The power consumption of EUT is lower than 75W, so the limit is not specified in</i>	
<i>EN 61000-3-2.</i>	



Flicker Result

Test Mode	Mode 1	Final Test Result	Pass
Parameter values recorded during the test:			
Vrms at the end of test (Volt):	230.36		
T-max (mS):	0	Test limit (mS): 500.0	Pass
Highest dc (%):	0.00	Test limit (%): 3.30	Pass
Highest dmax (%):	0.00	Test limit (%): 4.00	Pass
Highest Pst (10 min. period):	0.064	Test limit: 1.000	Pass

1 Test Result of ESD Immunity

Test Mode	Mode 1
Standard	Required Criteria B
Test Recorded	The EUT had "request time out" message during the test, but it will automatically return to normal conditions after the test.

Direct Application :

Test Point	Tested Voltage (kV)	Contact Discharge (Performance Criteria)	Air Discharge (Performance Criteria)
1,2	±2,4	A	-
3~5	±2,4,8	-	A
6,7	±2,4	A	-
8~10	±2,4	B	-
11	±2,4,8	-	A

Indirect Application :

Coupling Plan	Coupling Side	Test Voltage (kV)	Performance Criteria
HCP	Front / Rear / Right / Left	± 2, 4	A
VCP	Front / Rear / Right / Left	± 2, 4	A

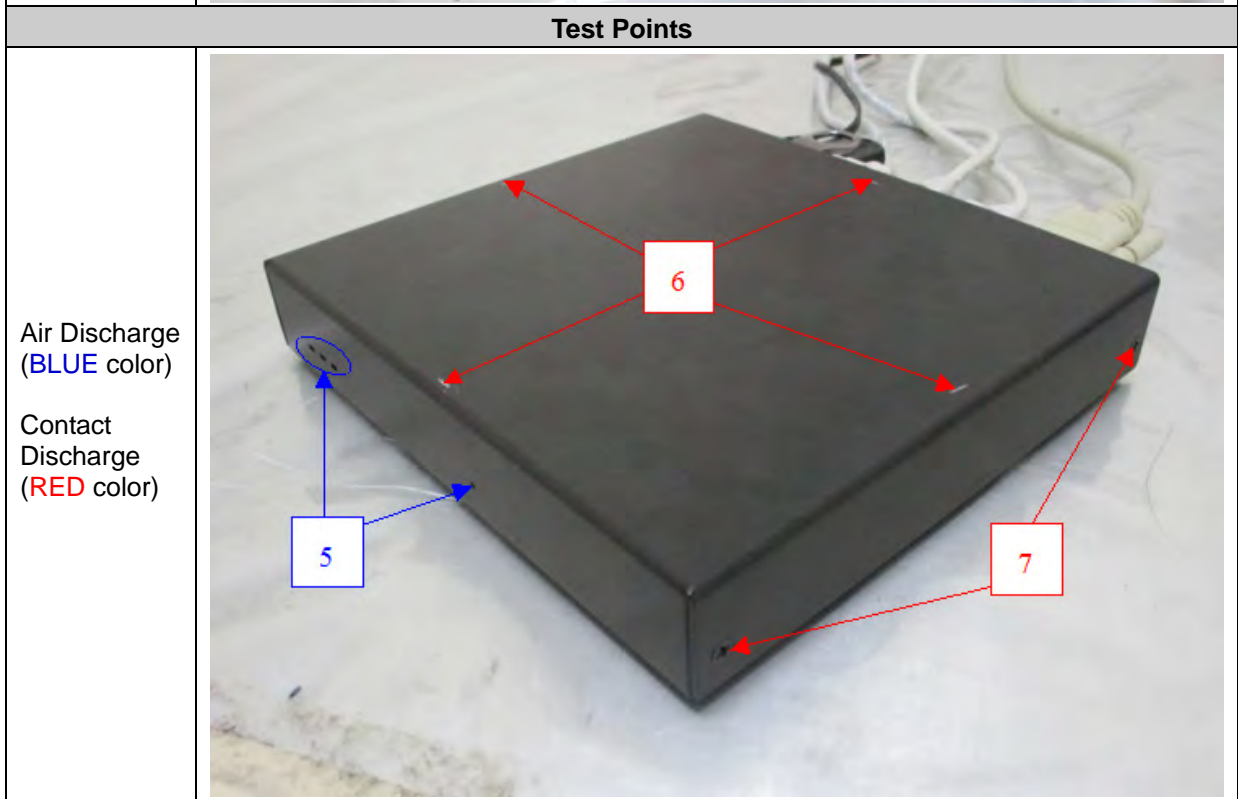
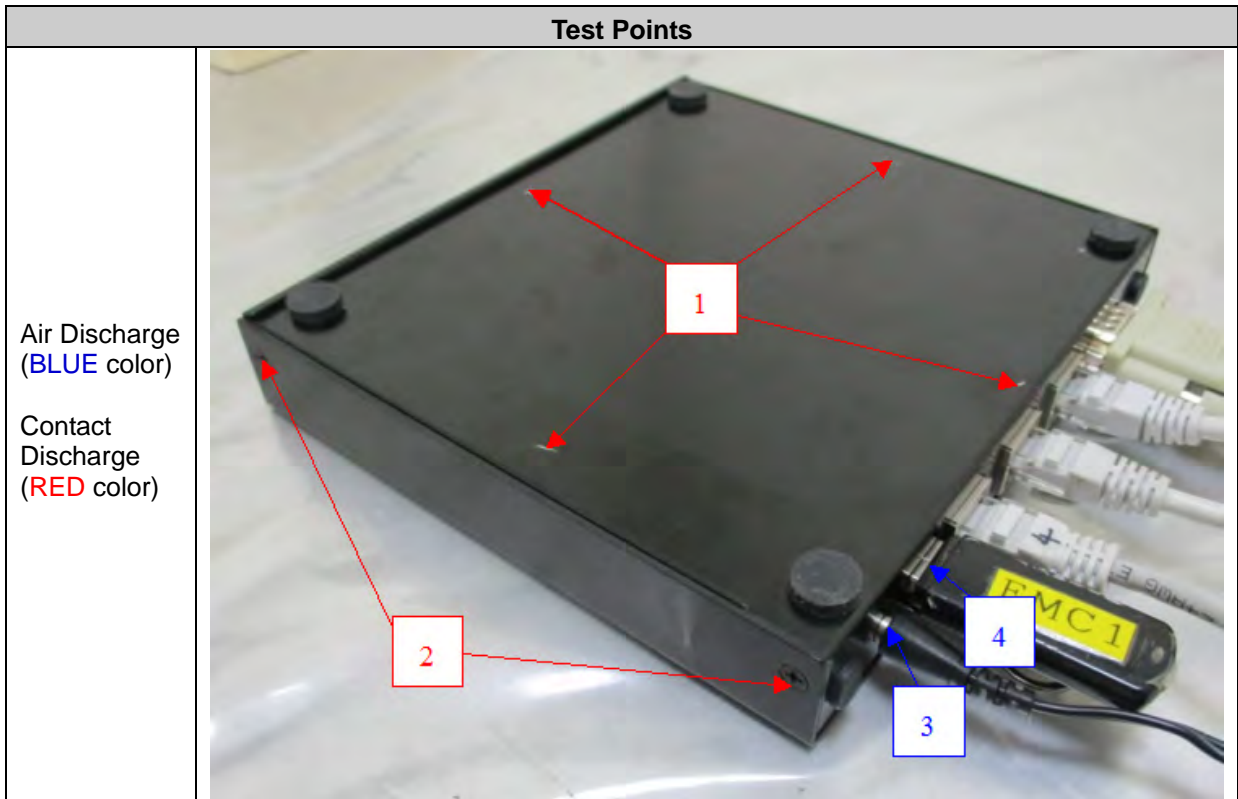

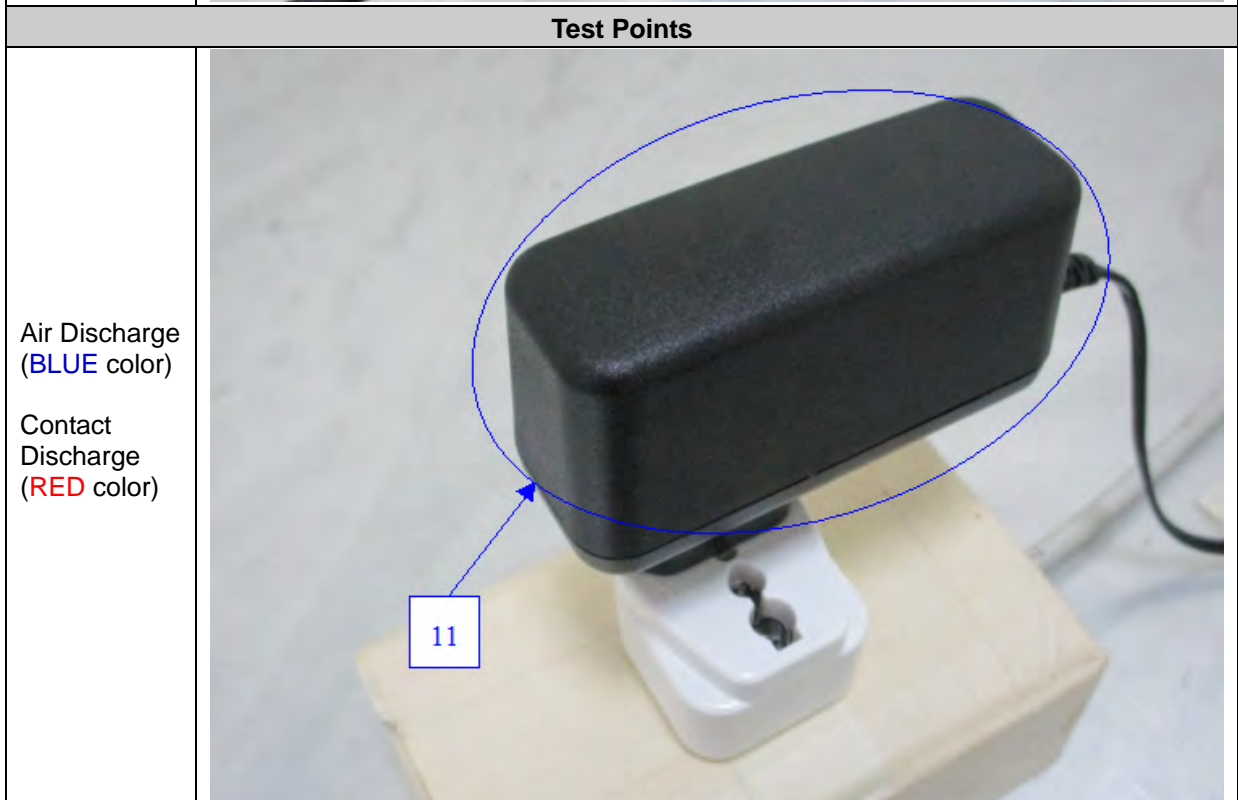
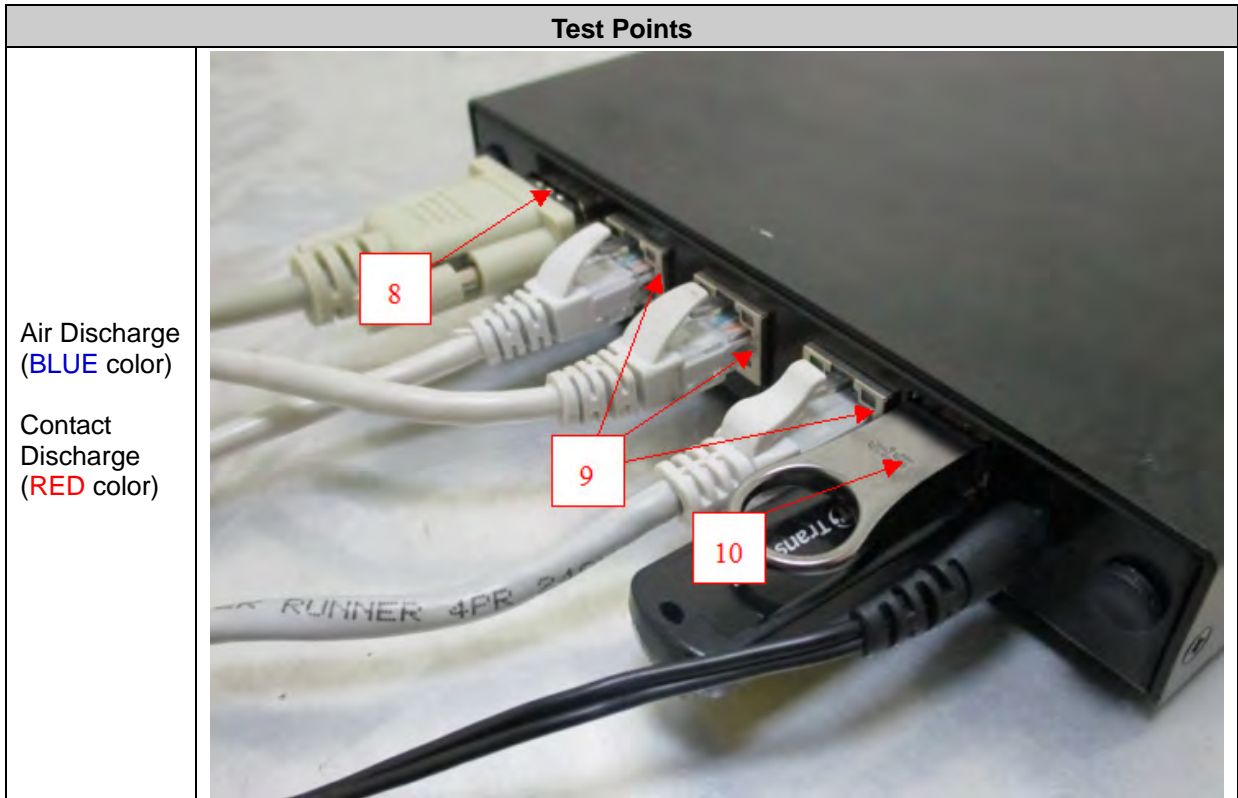

2 Test Result of RS Immunity

Test Mode	Mode 1
Standard	Required Criteria A
Test Recorded	There was no abnormal situation during the test compared with initial operation.

Frequency Range MHz	Field V/m	Antenna Polarization	EUT Face Exposed	Performance Criteria
80~1,000	3	Vertical	Front/Back/Right/Left	A
80~1,000	3	Horizontal	Front/Back/Right/Left	A

3 Test Result of EFT

Test Mode	Mode 1
Standard	Required Criteria B
Test Recorded	There was no abnormal situation during the test compared with initial operation.

AC Power Port :

AC Phase	Test Voltage (kV)
	±1 kV
L	A
N	A
L-N	A

Telecommunication Port :

Telecommunication Port	Test Voltage (kV)
	±0.5 kV
LAN	A

4 Test Result of Surge

Test Mode	Mode 1
Standard	Required Criteria B
Test Recorded	There was no abnormal situation during the test compared with initial operation.

AC Power Port:

Voltage (kV)	Test Location	Polarity	Phase Angle			
			0°	90°	180°	270°
0.5, 1	L - N	+	A	A	A	A
		-	A	A	A	A

5 Test Result of CS Immunity

Test Mode	Mode 1
Standard	Required Criteria A
Test Recorded	There was no abnormal situation during the test compared with initial operation.

Frequency Range MHz	V (r.m.s)	CDN	Coupling port	Performance Criteria
0.15 ~ 80	3	M016(M3)	AC	A
0.15 ~ 80	3	T8-10	LAN_1000Mbps	A

6 Test Result of MF Immunity

Test Mode	Mode 1
Standard	Required Criteria A
Test Recorded	There was no abnormal situation during the test compared with initial operation.

Power Frequency Magnetic Field	Testing duration	Coil Orientation	Performance Criteria
50 Hz, 1 A/m	1.0 Min	X-axis	A
50 Hz, 1 A/m	1.0 Min	Y-axis	A
50 Hz, 1 A/m	1.0 Min	Z-axis	A

7 Test Result of DIP

Test Mode	Mode 1
Standard	Required Criteria B/C/C
Test Recorded	The EUT had "reboot" situation happened during the test, need manual recover USB R/W function after the test.

Voltage Dip & Interruption :

Voltage (V)	Frequency (Hz)	% Reduction	Periods	ms	Performance Criteria
100	50	>95 %	0.5	10	A
		30 %	25	500	A
		>95%	250	5,000	C

Voltage (V)	Frequency (Hz)	% Reduction	Periods	ms	Performance Criteria
230	50	>95 %	0.5	10	A
		30 %	25	500	A
		>95%	250	5,000	C

Voltage (V)	Frequency (Hz)	% Reduction	Periods	ms	Performance Criteria
240	50	>95 %	0.5	10	A
		30 %	25	500	A
		>95%	250	5,000	C

1. Photographs of Conducted Emissions Test Configuration

FRONT VIEW

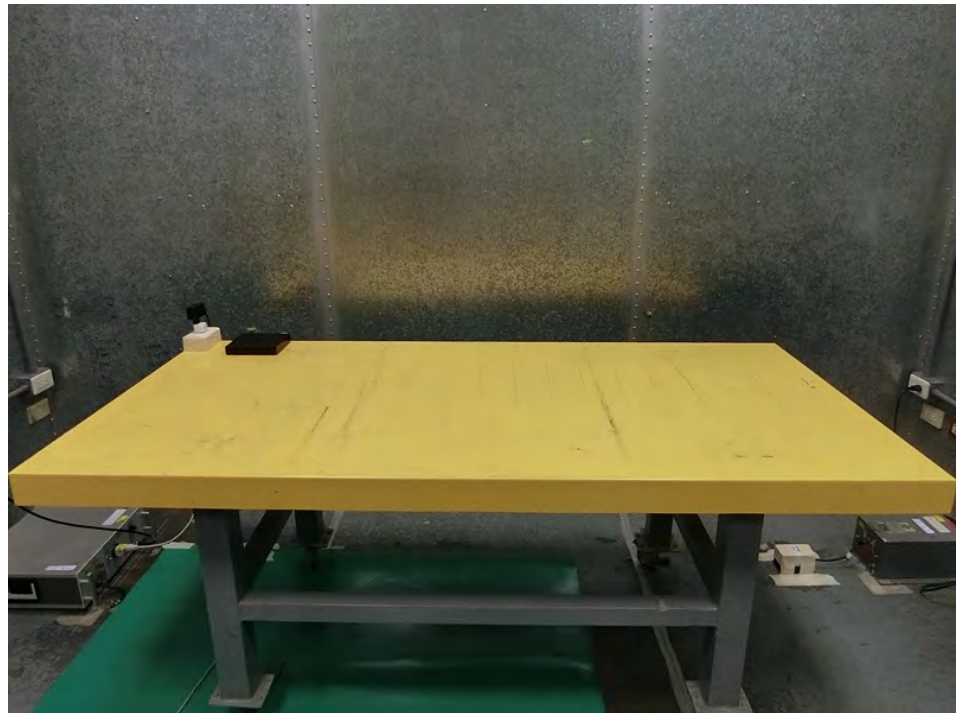

REAR VIEW



2. Photographs of Telecommunication Line Conducted Emissions Test Configuration

FRONT VIEW

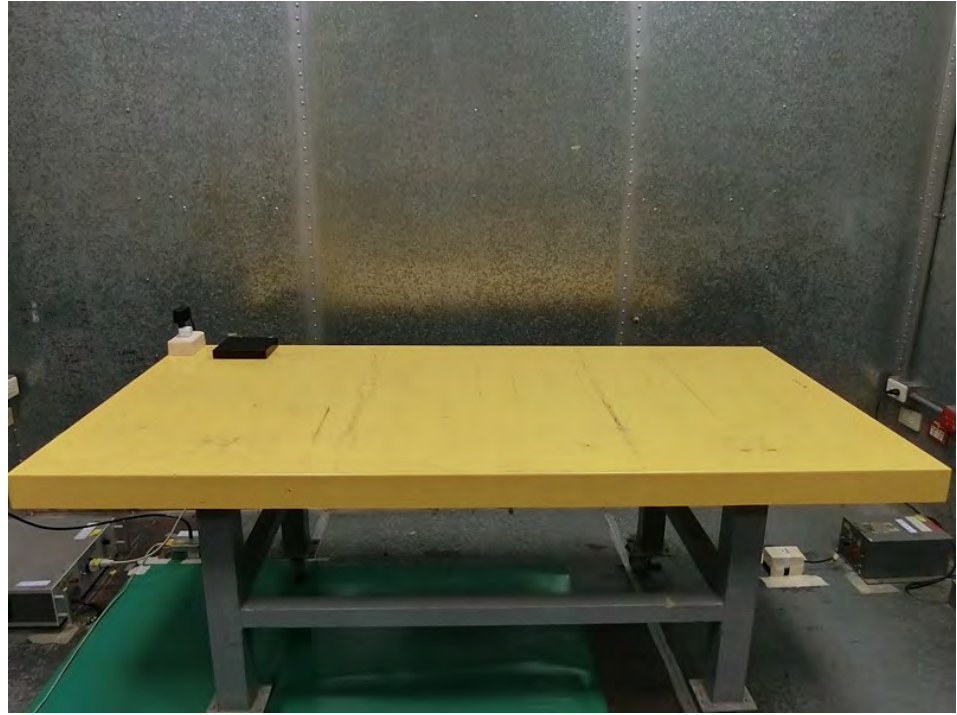

REAR VIEW



3. Photographs of Radiated Emissions Test Configuration

Test Configuration: 30MHz~1GHz / Test Mode: Mode 1

FRONT VIEW



REAR VIEW

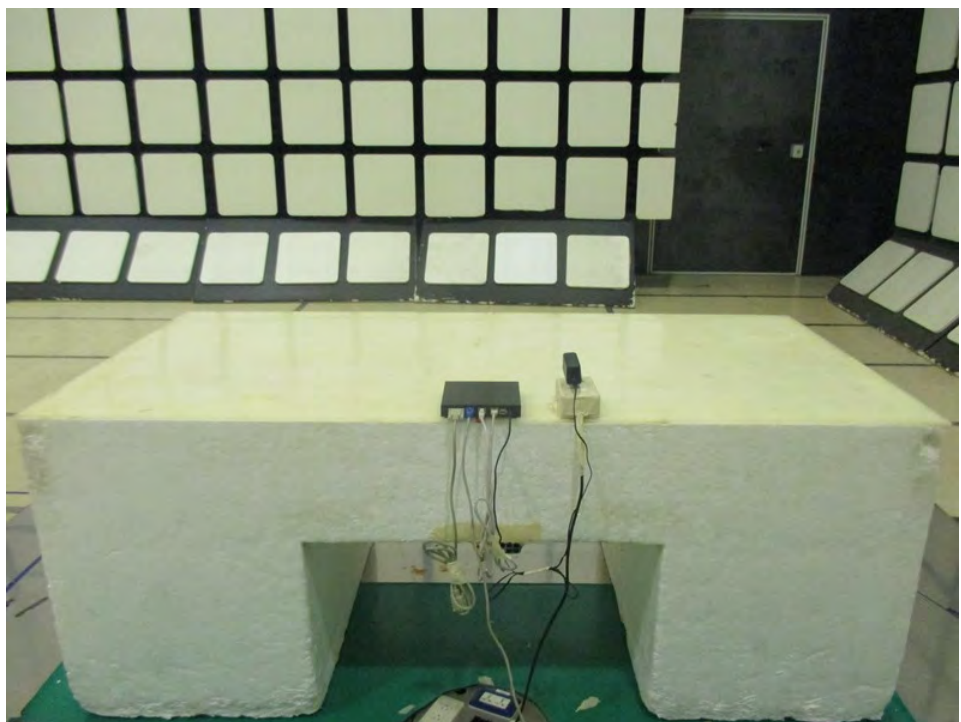

Test Configuration: Above 1GHz / Test Mode: Mode 1

FRONT VIEW



REAR VIEW

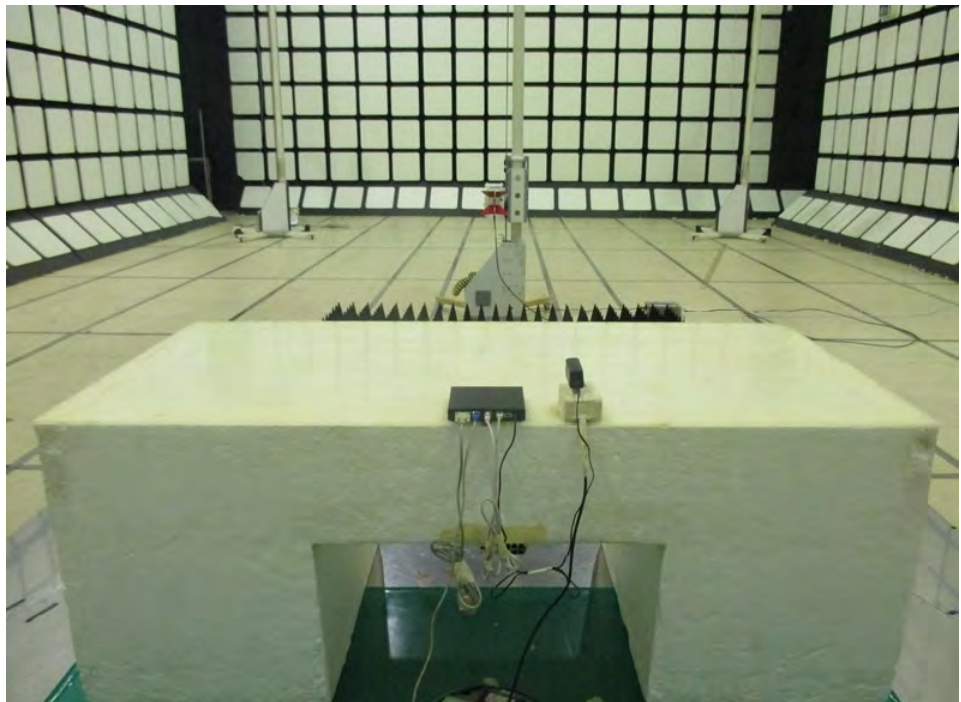

4. Photographs of Harmonic, Flicker Test Configuration

FRONT VIEW



5. Photographs of ESD Immunity Test Configuration

FRONT VIEW

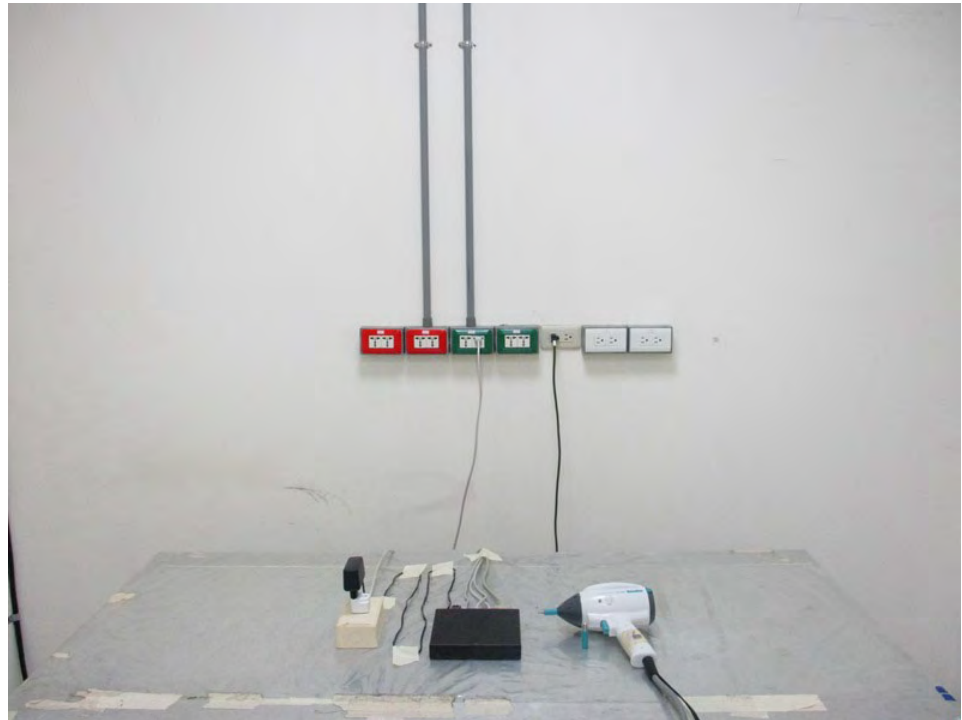

REAR VIEW

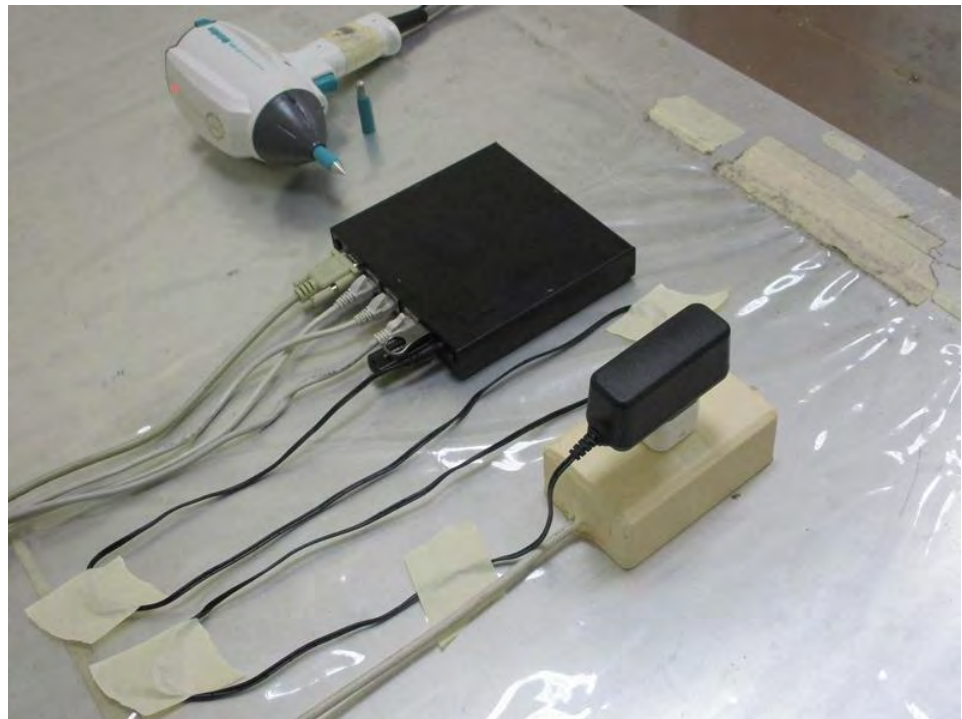

6. Photographs of RS Immunity Test Configuration

FRONT VIEW

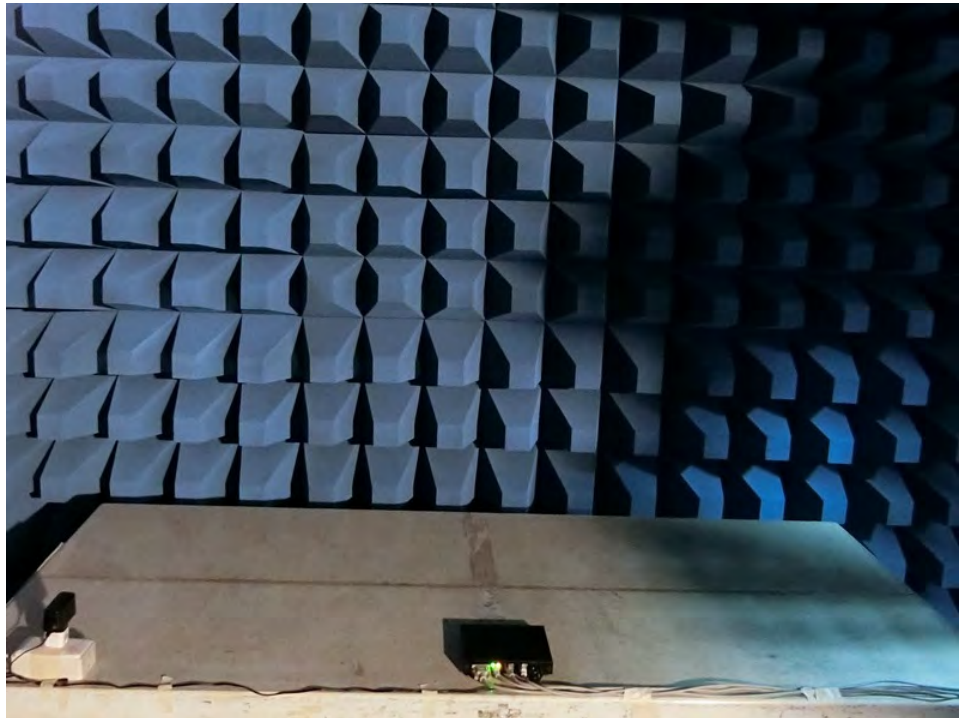

REAR VIEW

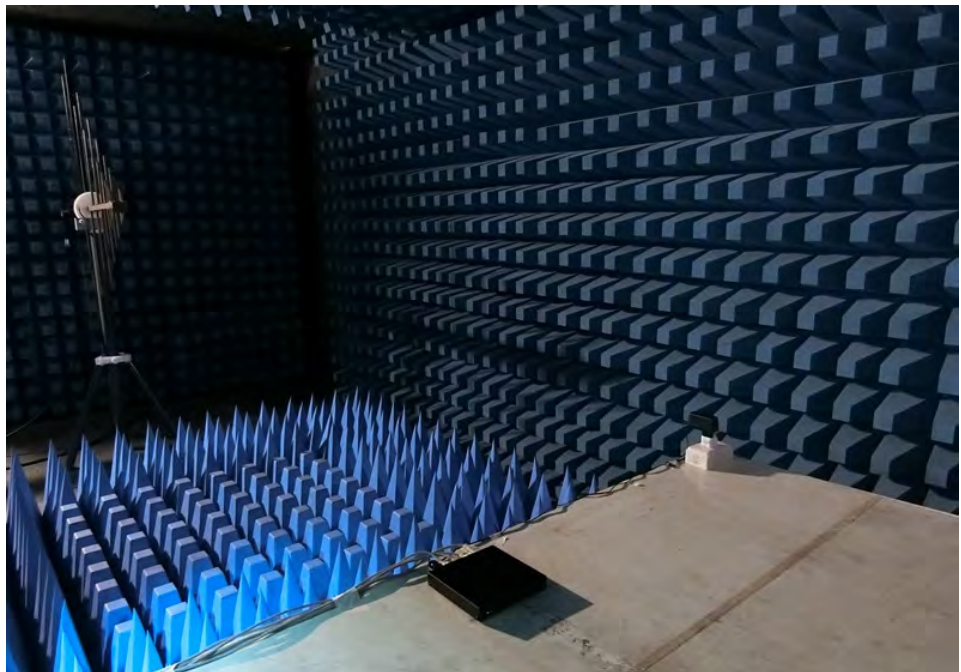

7. Photographs of EFT Test Configuration

FRONT VIEW

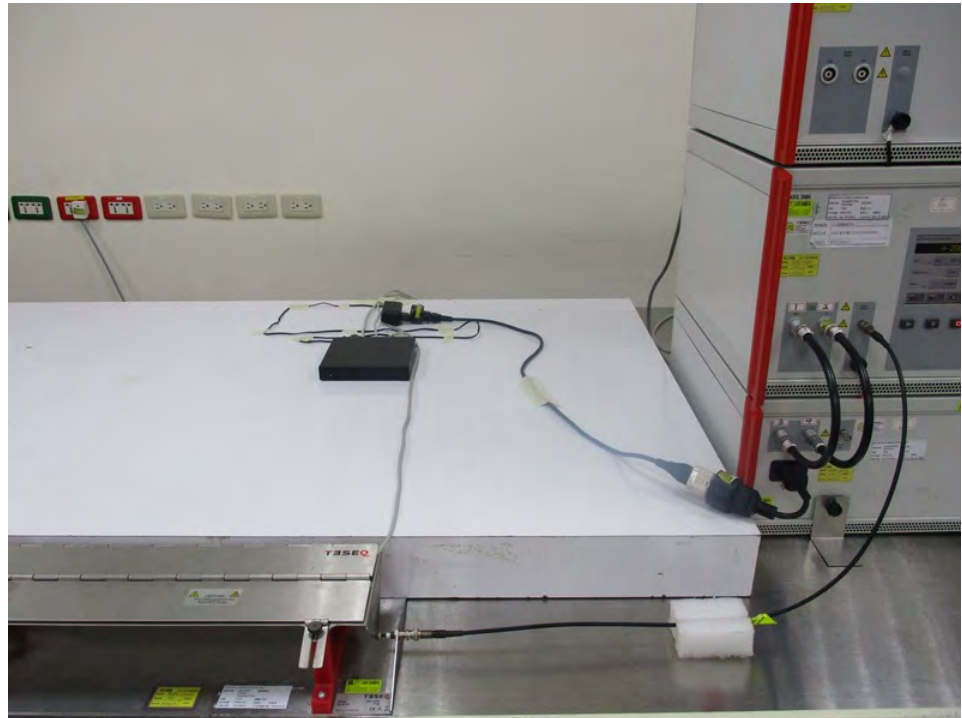

REAR VIEW

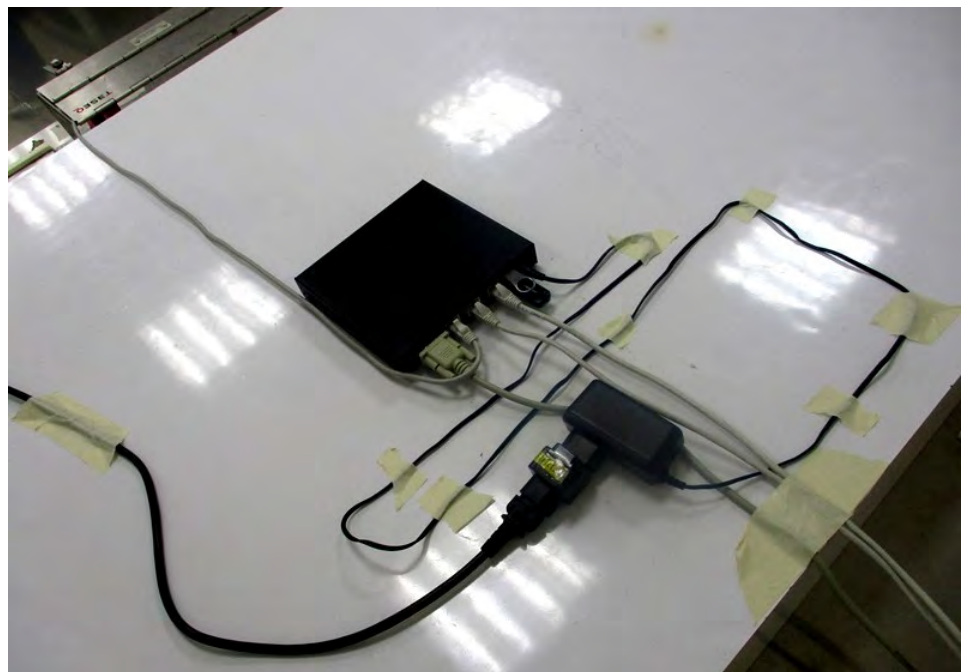

8. Photographs of Surge Test Configuration

FRONT VIEW

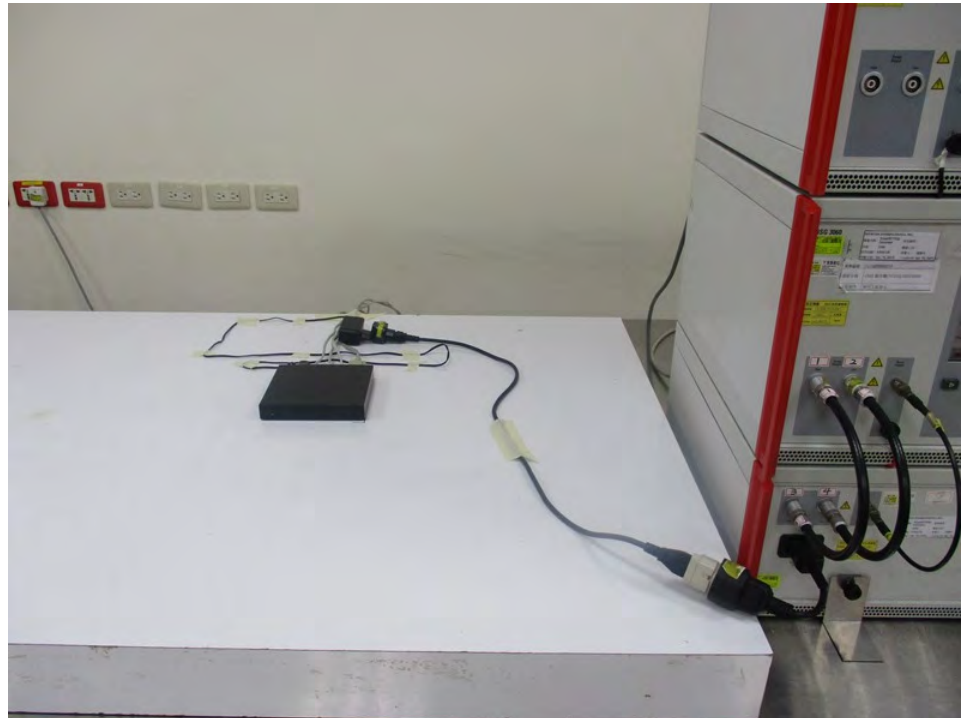

9. Photographs of CS Immunity Test Configuration

FRONT VIEW

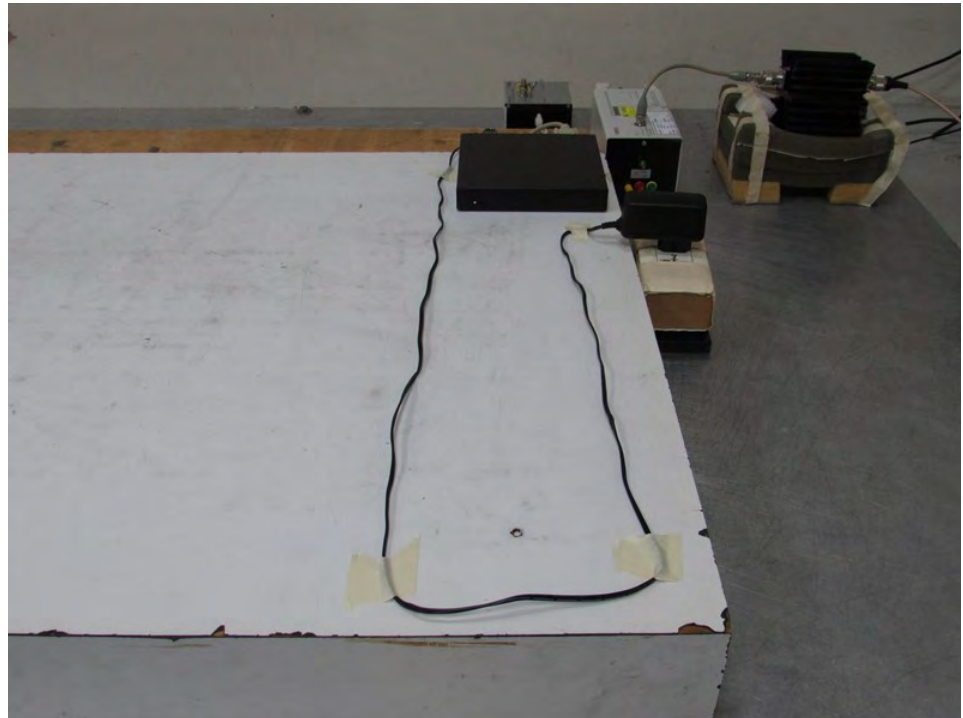

REAR VIEW

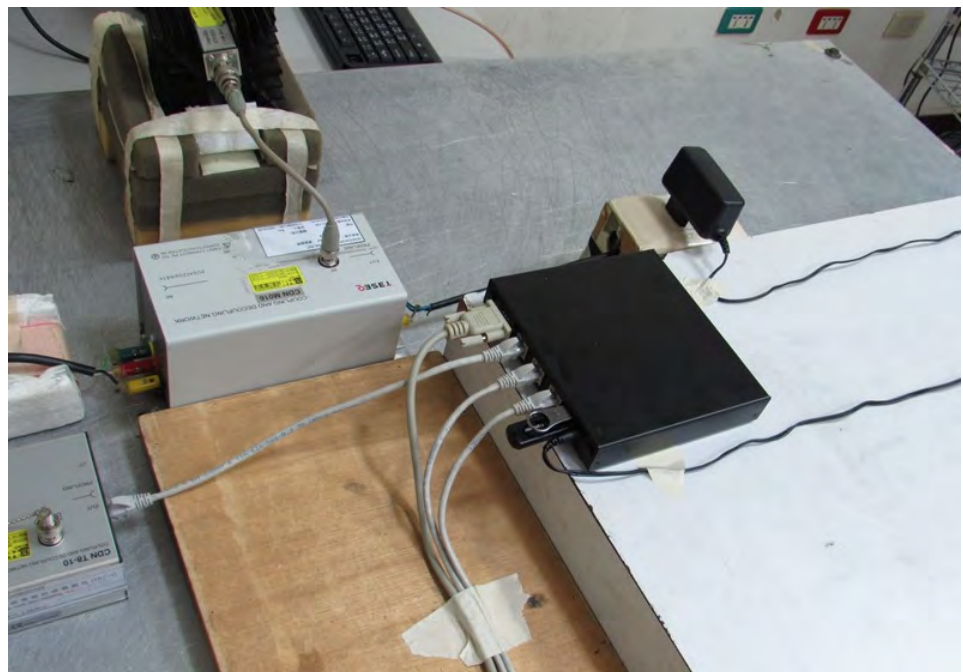

10. Photographs of MF Immunity Test Configuration

FRONT VIEW

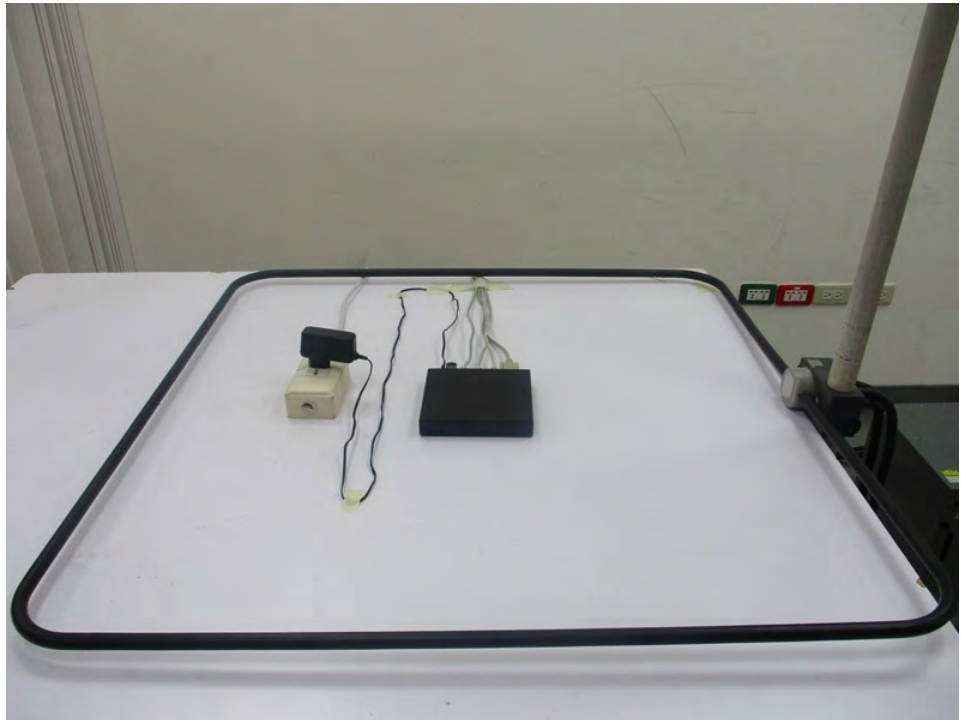

11. Photographs of DIP Test Configuration

FRONT VIEW

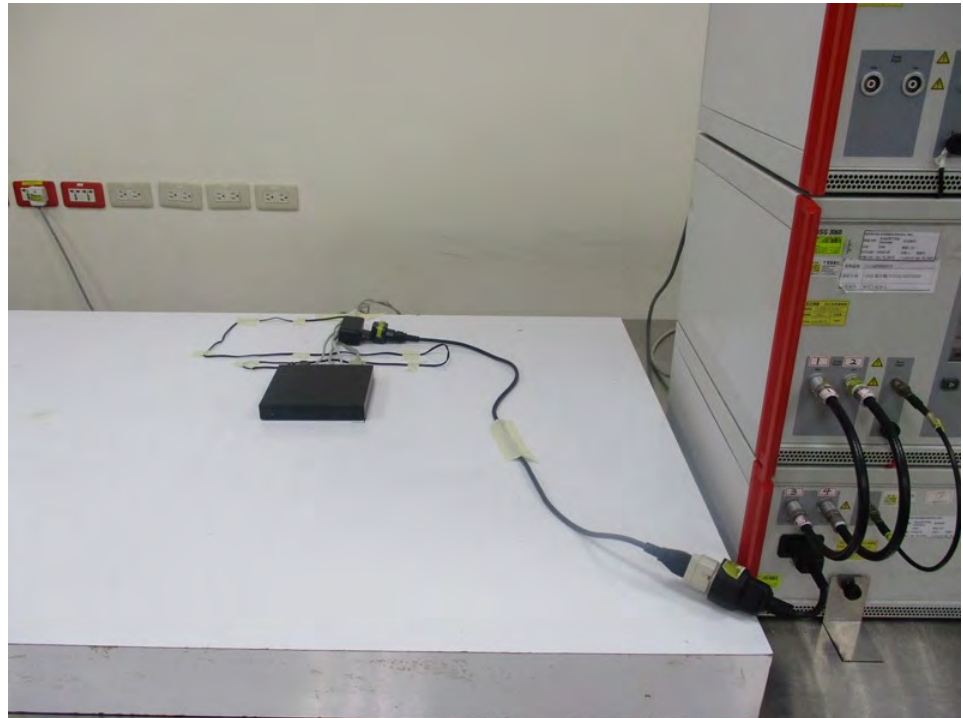

————THE END————